

CLIPS & CLAMPS

CLIPS & CLAMPS

Total range 2011

Wuerth Industrial Services Malaysia Sdn. Bhd. (879037-K)
Lot 806, Jalan Subang 5, Taman Perindustrian Subang,
47600 Subang Jaya, Selangor, Malaysia.
T +60 3 8021 0200 F +60 3-8021 0210
info@wuerth-industry.my
www.wuerth-industry.my

May not be reproduced, in part or in whole, without prior consent.
AU - MWV - IMS/SC - APPL - 9,050 - 07/11
Printed on environmentally friendly paper.

We reserve the right to carry out product changes at any time which we feel provide a quality improvement, even without prior announcement or notification. Illustrations may be example illustrations which may differ in appearance from the goods supplied. Errors are excepted. We assume no liability for printing errors. Our General Terms and Conditions apply.

CLIPS & CLAMPS

Total range 2011



CLIPS & CLAMPS

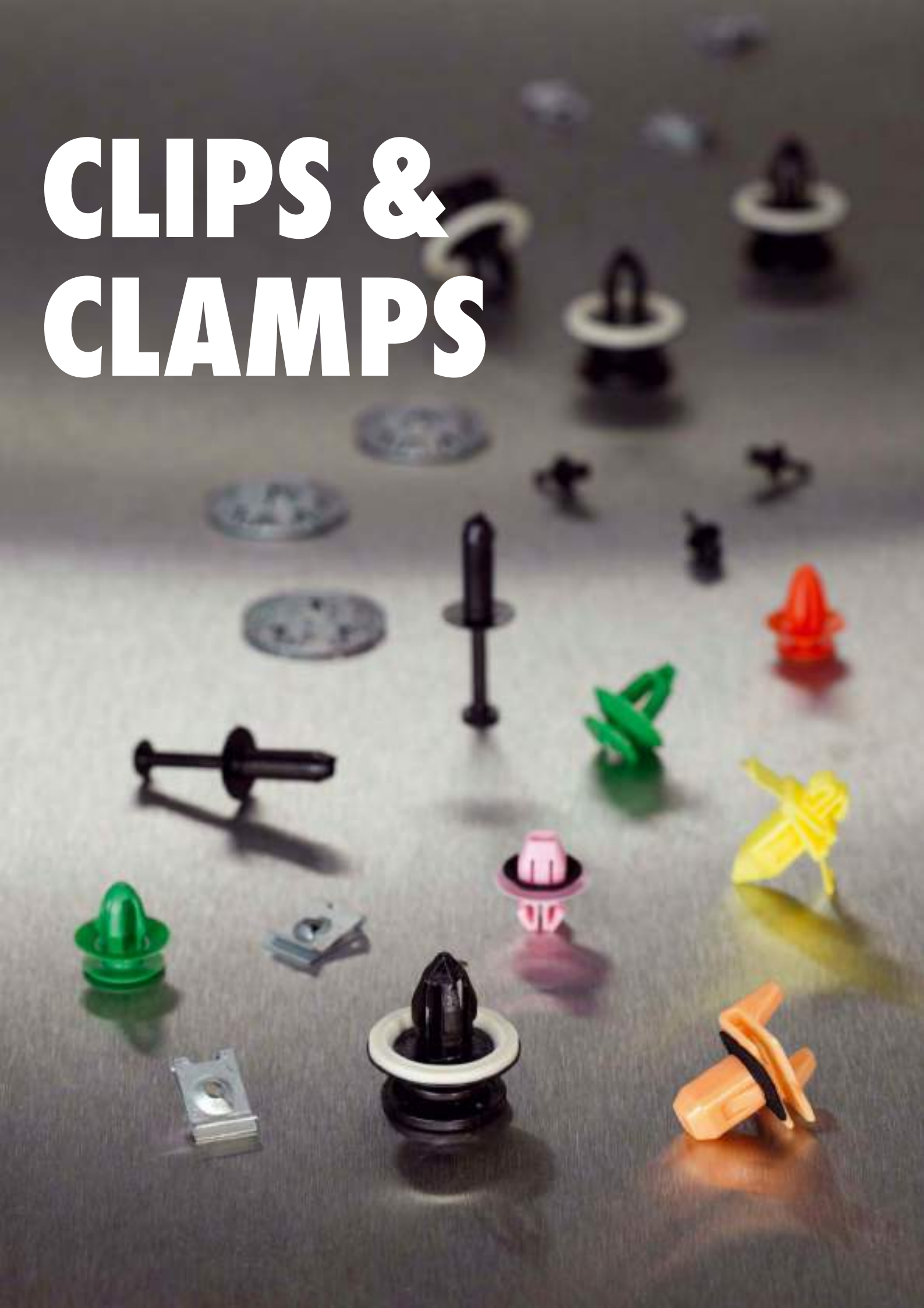

Universal	5 - 37
Audi	38 - 56
BMW	57 - 73
Citroen	74 - 88
Datsun	89 - 92
Fiat	93 - 96
Ford	97 - 104
Honda	105 - 111
Hyundai	112 - 114
Kia	115 - 117
Mazda	118 - 121
Mercedes	122 - 135
Mitsubishi	136 - 138
Opel	139 - 161
Porsche	162 - 164
Renault	165 - 175
Subaru	176 - 178
Suzuki	179 - 182
Toyota	182 - 190
Volvo	191 - 194

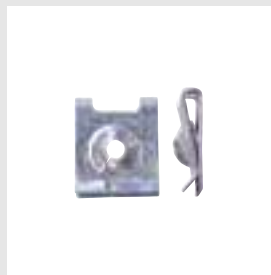

Art. No. 0500 119 56
Fig. No.: 1

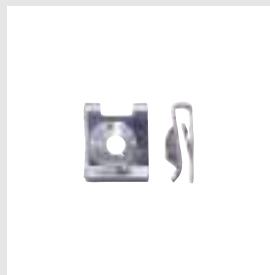

Art. No. 0500 131 74
Fig. No.: 2

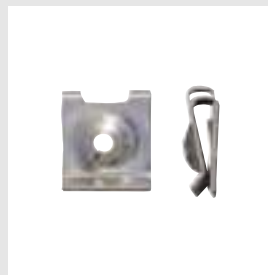

Art. No. 0501 104 064
Fig. No.: 3

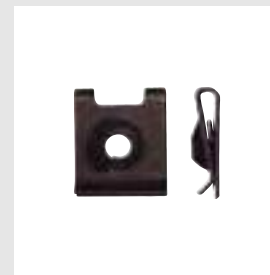

Art. No. 0500 136 24
Fig. No.: 4

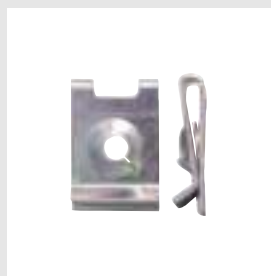

Art. No. 0500 121 9
Fig. No.: 5

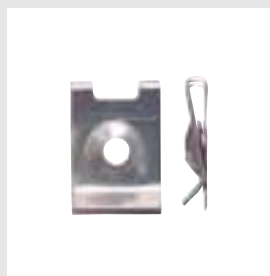

Art. No. 0500 113 46
Fig. No.: 6

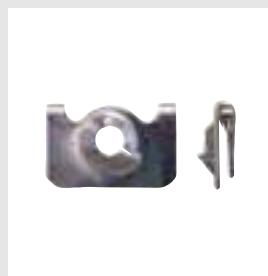

Art. No. 0501 105 108
Fig. No.: 7

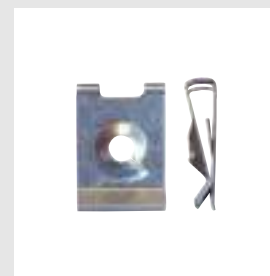

Art. No. 0500 113 47
Fig. No.: 8

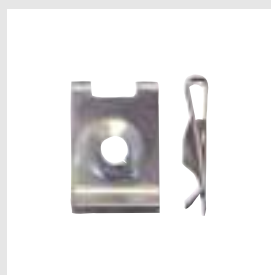

Art. No. 0500 113 62
Fig. No.: 9



Art. No. 0501 104 065
Fig. No.: 10

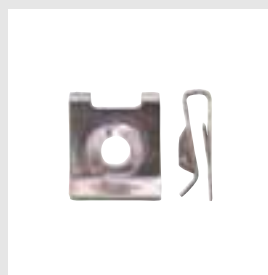

Art. No. 0500 116 67
Fig. No.: 11

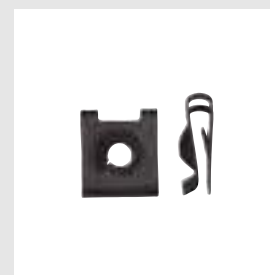

Art. No. 0500 136 29
Fig. No.: 12



Art. No. 0500 133 84
Fig. No.: 13



Art. No. 0500 132 19
Fig. No.: 14



Art. No. 0500 115 22
Fig. No.: 15

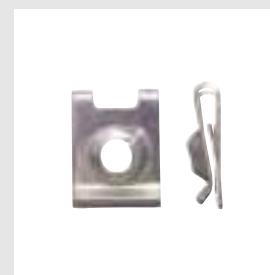

Art. No. 0500 131 33
Fig. No.: 16



Art. No. 0500 113 65
Fig. No.: 17

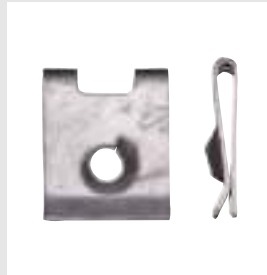

Art. No. 0500 114 70
Fig. No.: 18

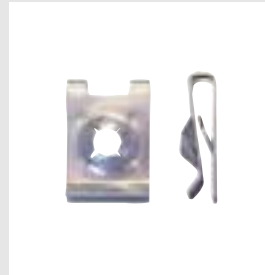

Art. No. 0500 139 56
Fig. No.: 19



Art. No. 0501 105 110
Fig. No.: 20



Art. No. 0500 136 05
Fig. No.: 21



Art. No. 0501 101 648
Fig. No.: 22



Art. No. 0501 101 647
Fig. No.: 23



Art. No. 0501 105 073
Fig. No.: 24



Art. No. 0500 113 21
Fig. No.: 25

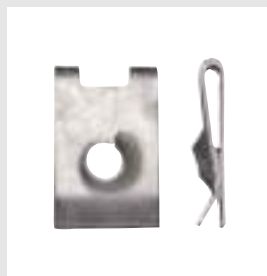

Art. No. 0500 115 77
Fig. No.: 26



Art. No. 0500 138 06
Fig. No.: 27



Art. No. 0500 114 27
Fig. No.: 28



Art. No. 0500 113 69
Fig. No.: 29



Art. No. 0500 692 0
Fig. No.: 30

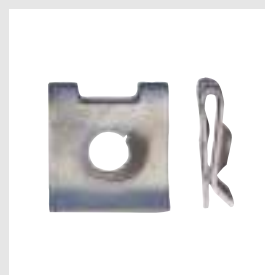

Art. No. 0500 114 04
Fig. No.: 31



Art. No. 0501 103 020
Fig. No.: 32



Art. No. 0500 117 61
Fig. No.: 33

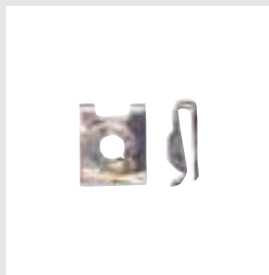

Art. No. 0500 136 58
Fig. No.: 34

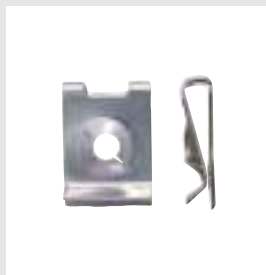

Art. No. 0501 105 109
Fig. No.: 35

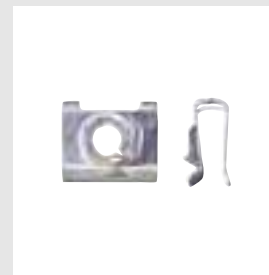

Art. No. 0500 137 04
Fig. No.: 36

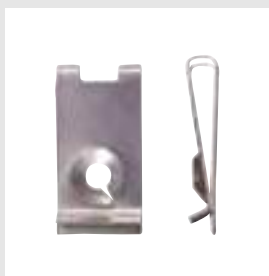

Art. No. 0500 132 51
Fig. No.: 37

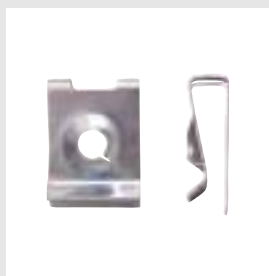

Art. No. 0500 117 45
Fig. No.: 38



Art. No. 0501 104 068
Fig. No.: 39

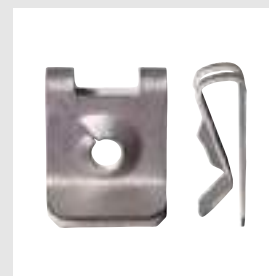

Art. No. 0501 104 067
Fig. No.: 40



Art. No. 0500 135 76
Fig. No.: 41



Art. No. 0500 136 37
Fig. No.: 42



Art. No. 0500 121 98
Fig. No.: 43

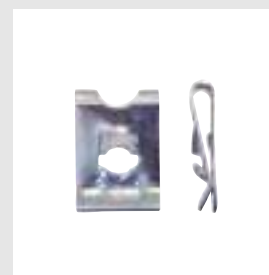

Art. No. 0500 053 6
Fig. No.: 44

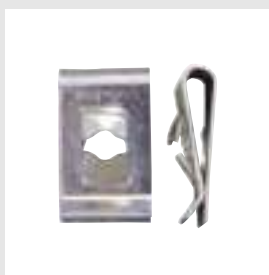

Art. No. 0500 053 7
Fig. No.: 45



Art. No. 0500 053 8
Fig. No.: 46

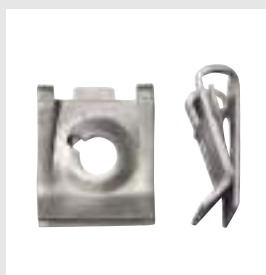

Art. No. 0501 167 009
Fig. No.: 47



Art. No. 0501 105 083
Fig. No.: 48



Art. No. 0501 103 052
Fig. No.: 49



Art. No. 0501 104 120
Fig. No.: 50



Art. No. 0501 106 075
Fig. No.: 51

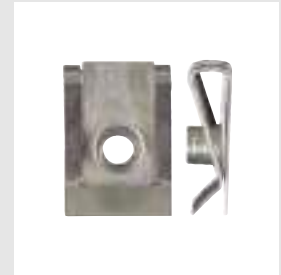

Art. No. 0500 535 25
Fig. No.: 52



Art. No. 0500 533 12
Fig. No.: 53



Art. No. 0501 101 646
Fig. No.: 54



Art. No. 0501 104 119
Fig. No.: 55



Art. No. 0500 408 0
Fig. No.: 56



Art. No. 0501 106 061
Fig. No.: 57



Art. No. 0501 102 005
Fig. No.: 58



Art. No. 0501 102 026
Fig. No.: 59



Art. No. 0501 101 666
Fig. No.: 60



Art. No. 0501 101 645
Fig. No.: 61



Art. No. 0500 132 04
Fig. No.: 62



Art. No. 0500 114 03
Fig. No.: 63



Art. No. 0501 104 066
Fig. No.: 64



Art. No. 0500 595 0

Fig. No.: 65

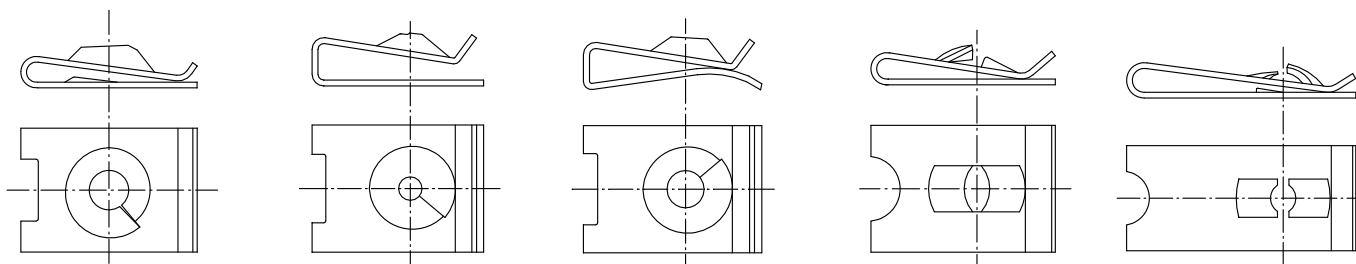

Form A

Form B

Form C

Form D

Form F

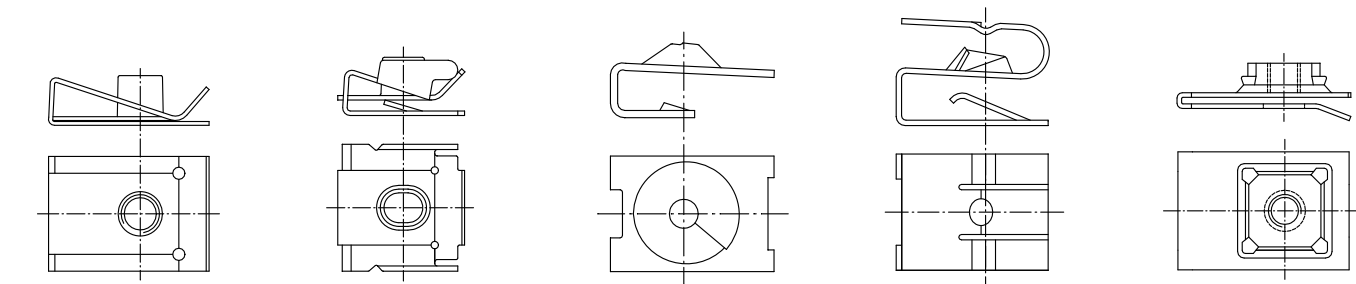

Form I

Form L

Form N

Form R

Form T

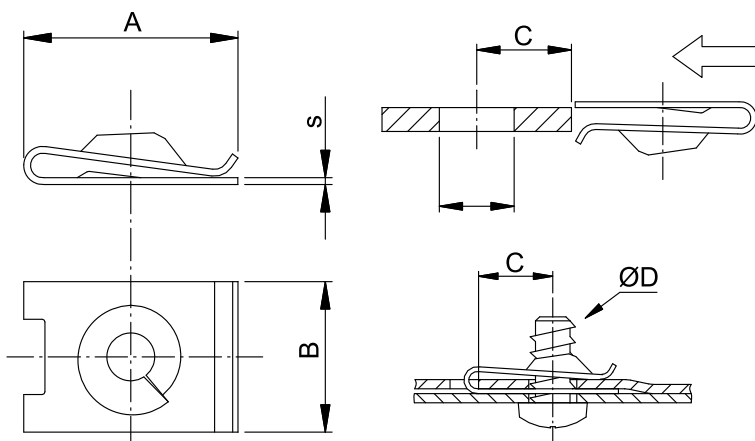

Art. No.	Shape	Dia. D	Att. thickness	A	B	C	Fig.	P. Qty.
0500 119 56	A	2,90	0,50 - 1,50	13,00	11,00	6,00	1	100
0500 131 74	A	2,90	0,75 - 1,60	9,90	8,00	4,50	2	100
0501 104 064	A	2,90	1,25 - 2,50	12,50	11,00	5,75	3	100
0500 136 24	A	3,50	0,50 - 1,50	13,00	11,00	6,00	4	100
0500 121 9	A	3,50	0,50 - 1,75	16,50	11,00	7,20	5	100
0500 113 46	A	3,90	0,50 - 1,75	16,50	11,00	7,50	6	50
0501 105 108	A	3,90	0,75 - 1,00	8,00	15,50	3,50	7	100
0500 113 47	A	3,90	1,00 - 3,00	16,00	11,00	7,00	8	100
0500 113 62	A	4,20	0,50 - 1,75	16,50	11,00	7,50	9	100
0501 104 065	A	4,20	1,00 - 2,05	16,50	11,00	7,50	10	100
0500 116 67	A	4,20	1,25 - 2,00	12,75	11,00	5,80	11	100
0500 136 29	A	4,20	2,00 - 2,50	12,50	11,00	5,50	12	100
0500 133 84	A	4,80	0,50 - 1,70	16,70	11,00	7,50	13	100
0500 132 19	A	4,80	0,50 - 1,70	24,90	11,00	16,00	14	100
0500 115 22	A	4,80	0,50 - 1,75	16,60	11,00	7,50	15	100
0500 131 33	A	4,80	0,60 - 1,70	14,70	11,00	7,20	16	100
0500 113 65	A	4,80	0,70 - 2,00	16,00	14,50	9,00	17	50
0500 114 70	A	4,80	0,85 - 1,70	19,70	16,00	11,00	18	50

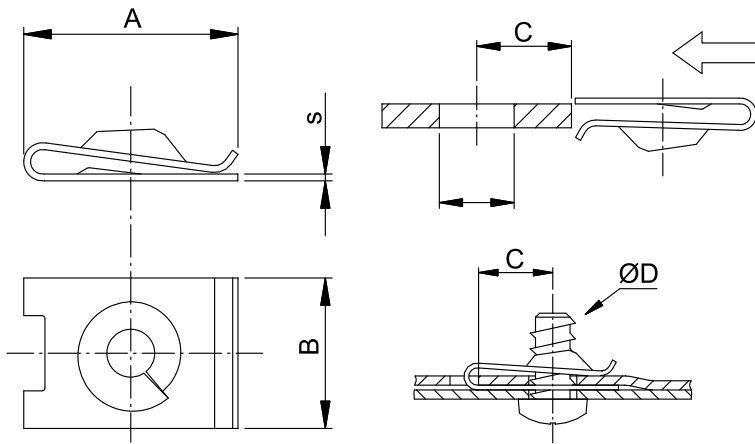

Art. No.	Shape	Dia. D	Att. thickness	A	B	C	Fig.	P. Qty.
0500 139 56**	A	4,80	1,70 - 2,30	16,50	11,00	7,20	19	100
0501 105 110	A	4,80	1,70 - 2,30	16,60	11,00	7,20	20	100
0500 136 05	A	4,80	2,50	19,00	12,50	8,50	21	50
0501 101 648	A	4,80	2,50 - 2,80	16,50	12,50	8,75	22	100
0501 101 647	A	4,80	2,50 - 3,50	16,50	11,00	7,20	23	100
0501 105 073	A	4,80	2,50 - 3,50	16,50	11,50	7,20	24	100
0500 113 21	A	4,90	0,75 - 1,50	16,50	11,00	7,20	25	100
0500 115 77	A	5,50	1,25 - 2,00	20,80	13,00	10,70	26	100
0500 138 06**	A	5,50	3,00 - 4,00	23,70	16,00	12,00	27	50
0500 114 27	A	6,30	0,70 - 1,50	24,80	16,00	10,50	28	100
0500 113 69	A	6,30	0,70 - 1,50	24,80	16,00	13,00	29	100
0500 692 0	A	6,30	0,80 - 2,00	16,80	16,00	7,50	30	50
0500 114 04	A	6,30	0,85 - 1,70	16,80	16,00	7,50	31	100
0501 103 020	A	6,30	3,00 - 4,00	23,70	16,00	12,00	32	100
0500 117 61	A	8,00	1,25 - 2,00	22,80	18,00	11,00	33	50
0500 136 58	B	3,50	1,20 - 1,70	9,30	8,00	4,50	34	100
0501 105 109	B	3,90	1,50 - 3,00	16,00	11,00	7,00	35	100
0500 137 04	B	3,90	2,50 - 3,00	9,20	11,00	4,00	36	100
0500 132 51	B	4,20	1,75 - 2,75	22,00	11,00	14,00	37	100
0500 117 45	B	4,20	3,00 - 4,00	15,50	11,00	6,50	38	100
0501 104 068	B	4,80	0,50 - 2,50	28,00	15,00	16,00	39	100
0501 104 067	B	4,80	2,50 - 5,00	20,00	15,00	8,00	40	100
0500 135 76	B	4,80	5,00 - 6,00	22,60	16,00	11,00	41	100
0500 136 37	B	5,50	3,00 - 4,00	16,20	14,50	7,20	42	100
0500 121 98	C	5,50	0,75 - 1,50	22,30	15,00	16,00	43	100
0500 053 6	D	4,20	0,60 - 1,70	16,00	11,00	7,50	44	100
0500 053 7	D	4,80	0,70 - 3,00	20,00	12,00	9,00	45	100
0500 053 8	F	5,50	0,90 - 2,60	26,20	15,10	11,10	46	100
0501 167 009	G	6,35	0,50 - 4,00	19,00	16,00	8,00	47	100
0501 105 083	I	M5	0,80 - 4,30	16,60	15,00	7,00	48	25
0501 103 052**	I	M5	0,80 - 4,30	20,40	15,00	10,50	49	100
0501 104 120	I	M5	0,80 - 4,30	20,40	15,00	10,50	50	100
0501 106 075	I	M5	0,80 - 4,30	20,40	15,00	10,50	51	50
0500 535 25	I	M5	0,80 - 4,30	20,40	15,00	10,50	52	50
0500 533 12	I	M6	0,50 - 4,00	23,60	16,00	11,50	53	100
0501 101 646	I	M6	0,50 - 4,00	23,60	16,00	11,50	54	100
0501 104 119	I	M6	0,50 - 4,80	23,60	16,00	11,50	55	100
0500 408 0**	I	M6	0,70 - 4,00	23,80	16,00	11,50	56	25
0501 106 061	I	M6	0,80 - 2,00	18,60	16,30	9,70	57	50
0501 102 005	I	M8	0,80 - 4,00	27,50	18,00	13,00	58	100

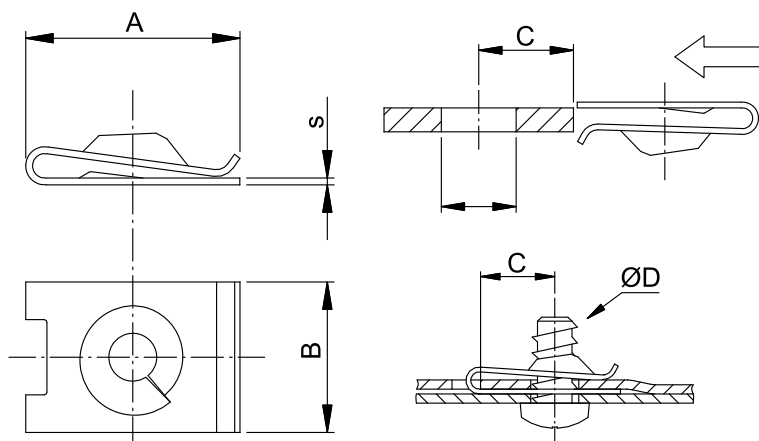

Art. No.	Shape	Dia. D	Att. thickness	A	B	C	Fig.	P. Qty.
0501 102 026 **	I	M8	0,80 - 4,00	27,50	18,00	13,00	59	10
0501 101 666 **	D	4,20	0,80 - 2,00	16,00	12,00	6,50	60	100
0501 101 645 **	D	M5	0,80 - 4,00	16,60	17,00	7,00	61	100
0500 132 04	N	6,30	0,70 - 1,50	24,70	14,50	12,70	62	100
0500 114 03	N	6,30	0,70 - 1,50	25,00	14,50	12,50	63	100
0501 104 066	R	4,80	1,50 - 2,50	20,70	18,50	10,00	64	100
0500 595 0	T	M6	0,60 - 1,50	26,50	18,00	10,00	65	25

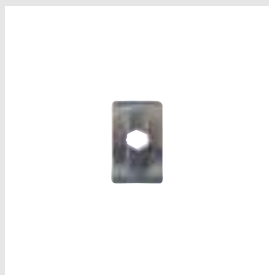

Art. No. 0500 111 84
Fig. No.: 1

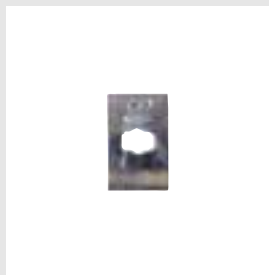

Art. No. 0500 111 41
Fig. No.: 2

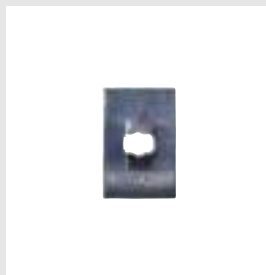

Art. No. 0501 105 113
Fig. No.: 3



Art. No. 0500 111 83
Fig. No.: 4

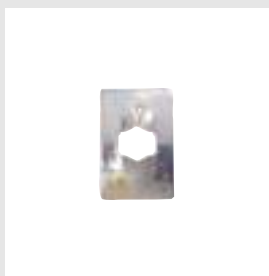

Art. No. 0500 111 82
Fig. No.: 5

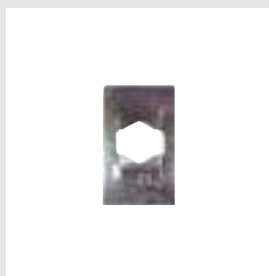

Art. No. 0500 113 55
Fig. No.: 6

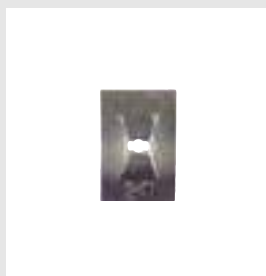

Art. No. 0500 111 85
Fig. No.: 7

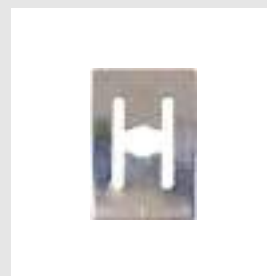

Art. No. 0500 113 67
Fig. No.: 8

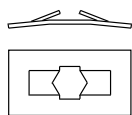
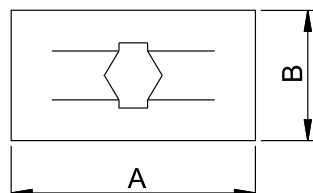
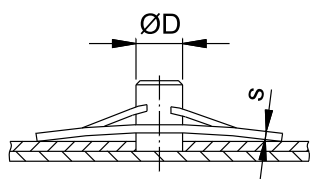

Form 1

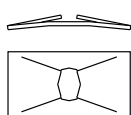

Form 2

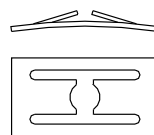

Form 3

Art. No.	Dia. D	A	B	s	Shape	Fig.	P. Qty.
0500 111 84	2,50	11,00	7,00	0,25	1	1	100
0500 111 41	3,00	12,60	8,00	0,35	1	2	100
0501 105 113	3,00	15,00	10,00	0,40	1	3	100
0500 111 83	3,60	12,70	8,00	0,35	1	4	100
0500 111 82	4,00	14,20	9,50	0,35	1	5	100
0500 113 55	5,00	15,80	9,50	0,35	1	6	100
0500 111 85	2,00	15,00	10,00	0,25	2	7	100
0500 113 67	4,50	20,00	13,50	0,50	3	8	100

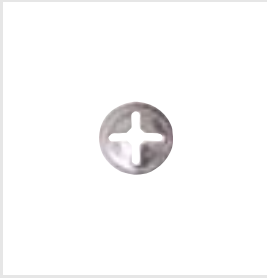

Art. No. 0500 117 53
Fig. No.: 1

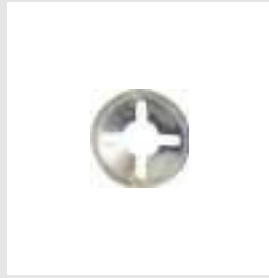

Art. No. 0500 518 36
Fig. No.: 2



Art. No. 0501 101 649
Fig. No.: 3

Clamping Ring

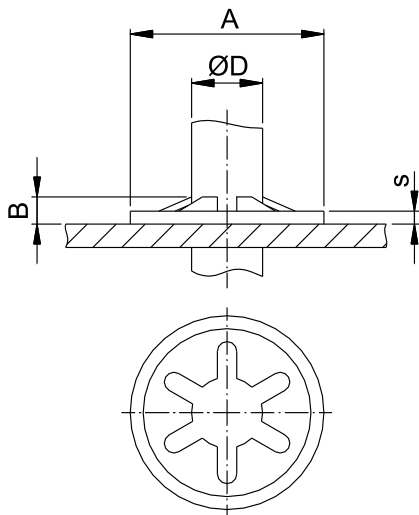

Art. No.	Dia. D	A	B	s	Material	Surface	Fig.	P. Qty.
0500 117 53	2,50	9,50	1,30	0,30	CK 67	GALV. CLR. PASSIV.	1	100
0500 518 36	4,90 - 5,00	13,00	1,20	0,35	CK 67	GALV. CLR. PASSIV.	2	100
0501 101 649	5,00	30,00	3,00	0,40	CK 67	GEO 321	3	100

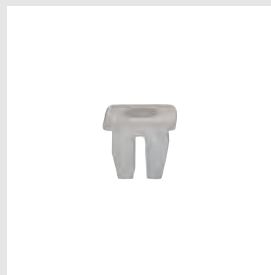

Art. No. 0501 167 059
Fig. No.: 1

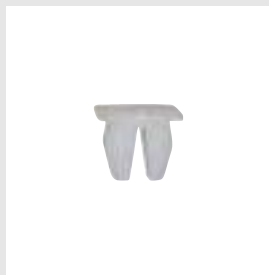

Art. No. 0501 101 631
Fig. No.: 2

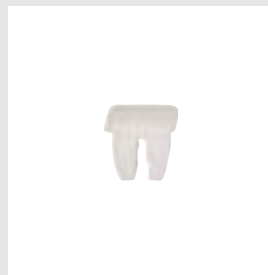

Art. No. 0501 121 123
Fig. No.: 3

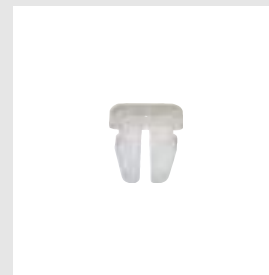

Art. No. 0500 134 54
Fig. No.: 4



Art. No. 0500 910 1
Fig. No.: 5



Art. No. 0501 104 117
Fig. No.: 6



Art. No. 0500 134 390
Fig. No.: 7



Art. No. 0501 106 069
Fig. No.: 8



Art. No. 0501 167 013
Fig. No.: 9

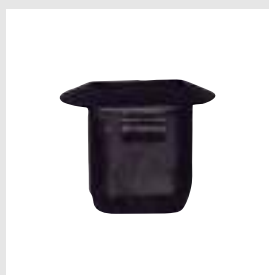

Art. No. 0501 167 015
Fig. No.: 10



Art. No. 0501 101 319
Fig. No.: 11



Art. No. 0500 134 420
Fig. No.: 12

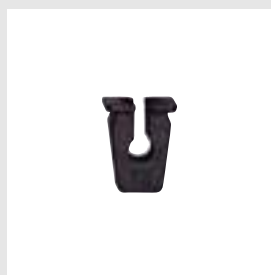

Art. No. 0500 879 33
Fig. No.: 13

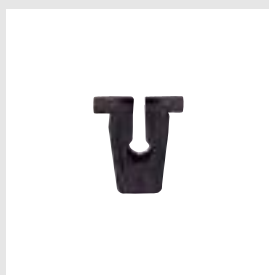

Art. No. 0501 101 001
Fig. No.: 14

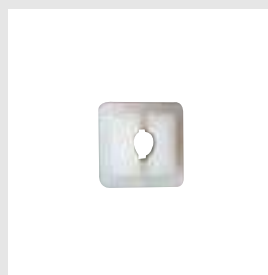

Art. No. 0500 771 1
Fig. No.: 15



Art. No. 0501 121 125
Fig. No.: 16

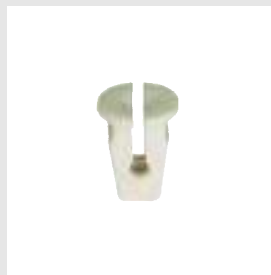

Art. No. 0501 101 349
Fig. No.: 17



Art. No. 0500 785 044
Fig. No.: 18



Art. No. 0501 167 014
Fig. No.: 19

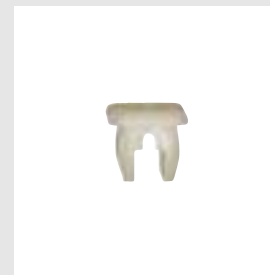

Art. No. 0500 134 480
Fig. No.: 20



Art. No. 0500 142 24
Fig. No.: 21

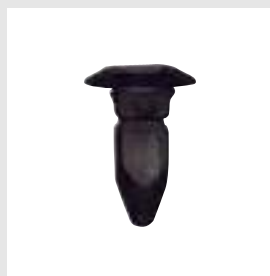

Art. No. 0501 101 233
Fig. No.: 22

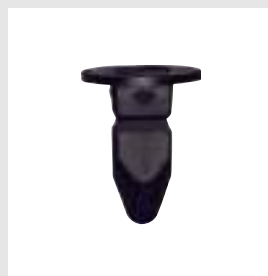

Art. No. 0501 101 229
Fig. No.: 23



Art. No. 0501 101 230
Fig. No.: 24



Art. No. 0501 102 006
Fig. No.: 25

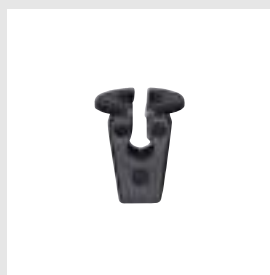

Art. No. 0500 879 32
Fig. No.: 26



Art. No. 0501 103 076
Fig. No.: 27



Art. No. 0501 103 009
Fig. No.: 28

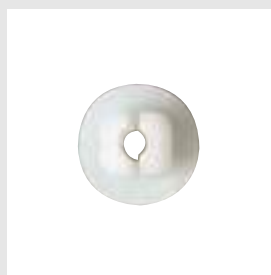

Art. No. 0500 775 8
Fig. No.: 29



Art. No. 0500 776 0
Fig. No.: 30



Art. No. 0501 102 008
Fig. No.: 31

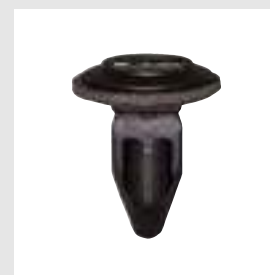

Art. No. 0501 103 010
Fig. No.: 32



Art. No. 0500 774 7
Fig. No.: 33



Art. No. 0500 134 550
Fig. No.: 34



Art. No. 0500 788 037
Fig. No.: 35



Art. No. 0500 151 97
Fig. No.: 36

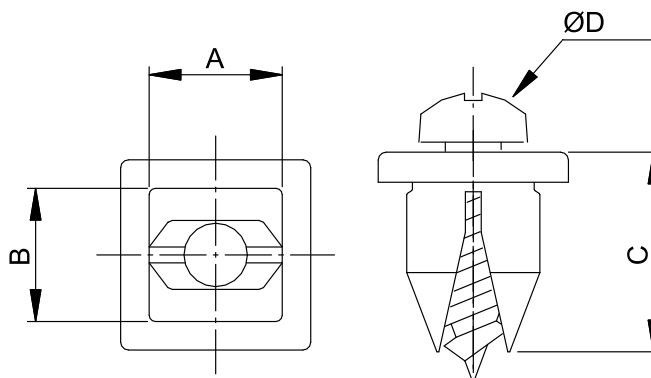

Art. No.	Dia. D	Att. thickness	A	B	C	Fig.	P. Qty.
0501 167 059	3,20	1,20	7,00	6,80	8,20	1	25
0501 101 631	3,50	0,80 - 1,50	6,70	6,70	8,00	2	100
0501 121 123	3,50	0,80 - 1,50	7,00	6,60	7,50	3	100
0500 134 54	3,50	2,70	7,10	6,50	9,20	4	50
0500 910 1	3,50	3,50	6,90	6,60	9,30	5	25
0501 104 117	3,90	0,80 - 1,00	7,10	6,60	14,80	6	100
0500 134 390	3,90	0,80 - 1,20	8,50	-	9,50	7	25
0501 106 069	3,90	0,80	8,00	8,00	26,00	8	50
0501 167 013	4,20	0,60 - 3,00	7,20	7,20	8,30	9	100
0501 167 015	4,20	0,60 - 3,00	7,20	14,20	17,00	10	50
0501 101 319	4,20	0,70 - 1,00	7,50	7,50	13,70	11	50
0500 134 420	4,20	0,70 - 1,00	7,80 - 8,00	7,80 - 8,00	16,50	12	25
0500 879 33	4,20	0,80 - 1,00	7,00	7,00	12,00	13	50
0501 101 001	4,20	0,80 - 1,00	7,00	7,00	12,00	14	50
0500 771 1	4,20	0,80 - 1,00	8,50	7,40	12,50	15	25
0501 121 125	4,20	0,80 - 2,50	7,20	14,20	10,00	16	100
0501 101 349	4,20	2,10	7,00 - 7,20	7,00 - 7,20	14,00	17	50
0500 785 044	4,20	3,50	7,00	7,00	8,00	18	25
0501 167 014	4,50	0,60 - 1,50	8,20	8,20	16,50	19	50
0500 134 480	4,80	0,50 - 3,00	7,00 - 7,30	7,00 - 7,30	8,40	20	100
0500 142 24	4,80	0,70 - 0,80	8,00 - 8,20	8,00 - 8,20	20,00	21	50
0501 101 233	4,80	0,70 - 1,50	7,50	7,50	21,50	22	50
0501 101 229	4,80	0,70 - 1,50	8,00	8,00	21,00	23	50
0501 101 230	4,80	0,70 - 1,50	8,00	8,00	21,00	24	50
0501 102 006	4,80	0,80 - 0,90	13,00 - 15,00	8,20 - 8,50	7,00	25	100
0500 879 32	4,80	0,80 - 1,00	7,40	6,60	14,00	26	50
0501 103 076	4,80	0,80 - 1,20	10,50	9,00	18,00	27	50
0501 103 009	4,80	0,80 - 1,20	13,00	11,00	18,30	28	50
0500 775 8	4,80	0,80 - 1,50	8,80	8,60	11,00	29	25
0500 776 0	4,80	0,80 - 2,00	9,00	8,50	9,00	30	25
0501 102 008	4,80	0,90	8,20	16,20	12,50	31	100
0501 103 010	5,50	0,70 - 1,50	18,00	10,00	25,50	32	25
0500 774 7	5,50	0,80 - 2,00	8,00	8,00	19,00	33	25
0500 134 550	5,50	0,80 - 2,00	9,50	10,00	11,00	34	25
0500 788 037	5,50	5,00	8,00	8,00	9,00	35	25
0500 151 97	5,80	0,80 - 1,20	8,10 - 8,30	8,10 - 8,30	12,00	36	50

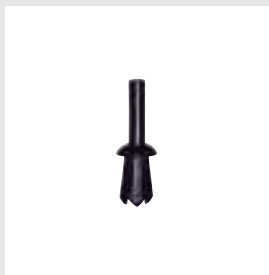

Art. No. 0500 126 94
Fig. No.: 1

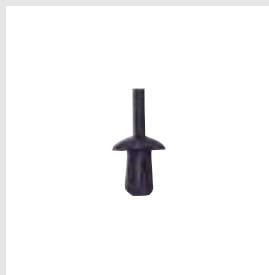

Art. No. 0500 143 00
Fig. No.: 2



Art. No. 0500 124 78
Fig. No.: 3

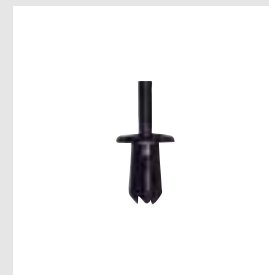

Art. No. 0501 121 118
Fig. No.: 4



Art. No. 0501 121 120
Fig. No.: 5



Art. No. 0500 128 21
Fig. No.: 6



Art. No. 0500 124 28
Fig. No.: 7



Art. No. 0501 167 058
Fig. No.: 8



Art. No. 0500 126 96
Fig. No.: 9



Art. No. 0500 521 4
Fig. No.: 10

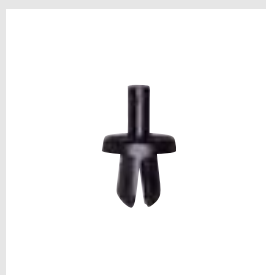

Art. No. 0500 128 54
Fig. No.: 11



Art. No. 0500 491 00
Fig. No.: 12



Art. No. 0501 103 035
Fig. No.: 13



Art. No. 0500 554 00
Fig. No.: 14



Art. No. 0501 103 065
Fig. No.: 15



Art. No. 0501 101 652
Fig. No.: 16



Art. No. 0500 127 10
Fig. No.: 17



Art. No. 0500 718
Fig. No.: 18



Art. No. 0501 104 084
Fig. No.: 19



Art. No. 0501 105 064
Fig. No.: 20

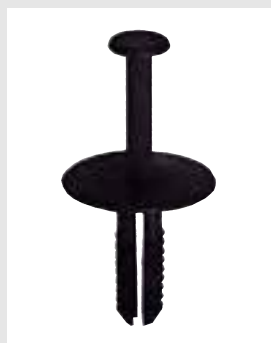

Art. No. 0501 103 017
Fig. No.: 21

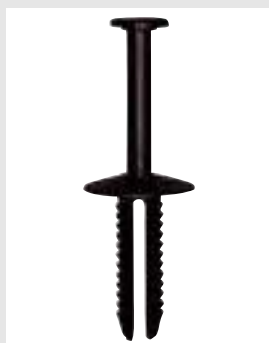

Art. No. 0501 105 065
Fig. No.: 22

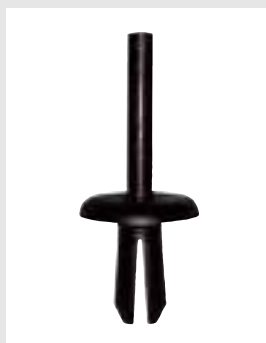

Art. No. 0500 141 42
Fig. No.: 23



Art. No. 0501 101 347
Fig. No.: 24



Art. No. 0501 121 121
Fig. No.: 25



Art. No. 0501 105 063
Fig. No.: 26



Art. No. 0501 105 078
Fig. No.: 27



Art. No. 0501 105 035
Fig. No.: 28



Art. No. 0501 105 016
Fig. No.: 29



Art. No. 0500 136 680
Fig. No.: 30



Art. No. 0501 104 122
Fig. No.: 31



Art. No. 0501 103 015
Fig. No.: 32

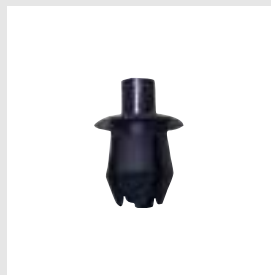

Art. No. 0500 937 7
Fig. No.: 33



Art. No. 0501 121 119
Fig. No.: 34



Art. No. 0501 101 000
Fig. No.: 35



Art. No. 0501 121 191
Fig. No.: 36



Art. No. 0500 40
Fig. No.: 37



Art. No. 0501 101 629
Fig. No.: 38



Art. No. 0501 104 070
Fig. No.: 39



Art. No. 0500 201 404
Fig. No.: 40



Art. No. 0500 148 02
Fig. No.: 41



Art. No. 0501 121 117
Fig. No.: 42



Art. No. 0501 101 628
Fig. No.: 43

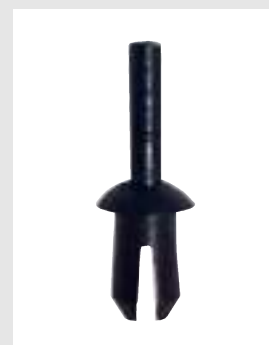

Art. No. 0501 104 038
Fig. No.: 44



Art. No. 0501 104 123
Fig. No.: 45



Art. No. 0501 121 190
Fig. No.: 46



Art. No. 0500 919 2
Fig. No.: 47



Art. No. 0501 105 084
Fig. No.: 48



Art. No. 0501 101 627

Fig. No.: 49

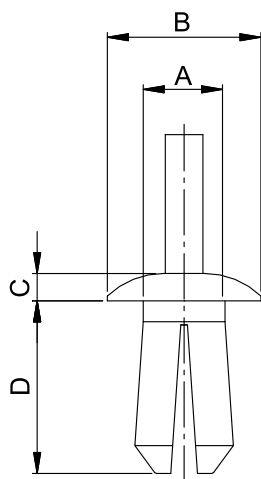

Art. No.	Att. hole	Att. thickness	A	B	C	D	Color	Fig.	P. Qty.
0500 126 94	3,00 - 3,60	0,80 - 4,50	3,00	4,80	1,30	6,20	S	1	50
0500 143 00	3,50 - 3,70	2,00 - 5,00	3,50	8,00	2,20	8,00	S	2	50
0500 124 78	3,80 - 4,00	2,50 - 5,00	3,60	8,00	2,00	7,00	S	3	50
0501 121 118	4,00 - 4,20	2,00 - 6,00	-	8,00	1,00	8,50	S	4	100
0501 121 120	4,55 - 5,15	3,00 - 8,00	4,50	15,00	3,00	11,50	S	5	25
0500 128 21	5,00 - 5,20	0,75 - 3,00	3,00	8,50	2,00	6,00	S	6	25
0500 124 28	5,00 - 5,20	1,50 - 5,00	5,00	10,00	2,00	8,00	S	7	50
0501 167 058	5,00 - 5,20	5,50 - 12,00	5,00	10,00	2,00	15,00	S	8	50
0500 126 96	5,00 - 5,50	3,00 - 8,00	5,00	10,00	2,00	11,50	N	9	25
0500 521 4	5,00 - 5,50	3,00 - 8,00	5,00	10,00	2,00	11,50	S	10	50
0500 128 54	5,00 - 5,70	1,50 - 5,00	5,00	10,00	2,00	7,50	S	11	25
0500 491 00	5,05 - 5,55	6,00 - 11,00	5,00	10,00	2,00	15,00	S	12	50
0501 103 035	5,50 - 6,40	2,50 - 7,00	5,50	16,00	2,00	11,00	S	13	25
0500 554 00	5,60 - 6,60	5,00 - 11,00	5,60	9,00	2,00	16,00	S	14	50
0501 103 065	5,90 - 6,10	4,40 - 5,80	5,90	16,00	3,00	10,40	S	15	25
0501 101 652	5,90 - 7,10	2,00 - 8,00	5,80	10,00	2,00	12,00	N	16	100
0500 127 10	5,90 - 7,10	2,00 - 8,00	5,80	10,00	2,00	12,00	S	17	50
0500 718	6,00	5,00 - 5,50	6,00	13,00	2,00	10,00	S	18	25
0501 104 084	6,00 - 6,10	1,50 - 6,00	-	10,00	1,30	10,70	S	19	50
0501 105 064	6,00 - 6,20	2,00 - 10,00	6,50	15,00	3,50	15,00	S	20	50
0501 103 017	6,00 - 6,20	7,00 - 15,00	6,50	20,00	4,00	20,00	S	21	25
0501 105 065	6,00 - 6,20	7,00 - 15,00	6,50	15,00	4,00	20,00	S	22	50
0500 141 42	6,00 - 6,20	7,50 - 8,60	6,00	16,00	2,50	14,50	S	23	25
0501 101 347	6,00 - 8,00	7,20 - 7,40	8,00	15,00	1,50	11,50	S	24	100
0501 121 121	6,50	3,80 - 6,00	6,40	22,00	-	13,80	S	25	25
0501 105 063	6,50 - 6,60	2,00 - 10,00	6,50	20,00	2,00	15,00	S	26	50
0501 105 078	6,50 - 6,60	2,00 - 10,00	6,50	20,00	3,50	17,00	S	27	50
0501 105 035	6,50 - 6,60	2,80 - 11,00	6,50	20,00	5,00	15,00	S	28	50
0501 105 016	6,60	1,00 - 2,50	6,60	20,00	2,50	9,00	S	29	50
0500 136 680	6,80 - 7,00	5,50 - 8,50	6,80	22,00	-	11,70	G	30	25
0501 104 122	7,00 - 7,20	4,00 - 7,00	7,00	18,00	2,50	16,50	S	31	100
0501 103 015	7,80	- 5,60	7,80	16,00	2,00	10,60	S	32	50
0500 937 7	7,80	2,40 - 6,80	7,80	12,30	1,00	11,00	S	33	100
0501 121 119	7,80 - 8,80	0,80 - 9,50	7,80	17,00	3,50	12,30	S	34	100
0501 101 000	7,90 - 8,70	4,00 - 7,00	7,90	16,00	2,00	12,00	S	35	100
0501 121 191	7,90 - 8,70	4,00 - 7,00	7,90	16,00	2,00	12,00	S	36	10
0500 40	8,00	2,00 - 4,50	8,00	20,00	2,50	9,40	S	37	50
0501 101 629	8,00	2,00 - 5,00	-	20,00	3,70	9,10	S	38	50
0501 104 070	8,00	2,00 - 5,00	-	20,00	3,70	9,10	G	39	100

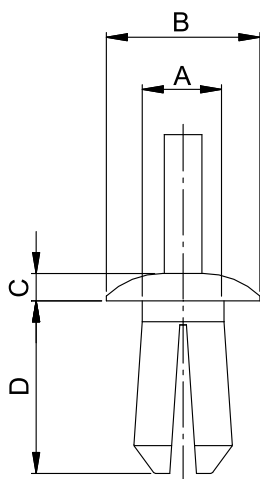

Art. No.	Att. hole	Att. thickness	A	B	C	D	Color	Fig.	P. Qty.
0500 201 404	8,00 - 8,20	3,00 - 10,00	8,70	20,00	3,30	14,00	S	40	25
0500 148 02	8,00 - 8,20	4,50 - 6,00	8,00	18,00	2,50	10,00	S	41	25
0501 121 117	8,00 - 8,20	5,00	8,00	20,00	6,00	14,00	S	42	50
0501 101 628	8,00 - 8,40	4,00 - 8,00	4,50	22,00	3,00	13,00	S	43	25
0501 104 038	8,00 - 8,60	5,50 - 10,00	8,00	13,00	3,00	15,00	S	44	50
0501 104 123	8,00 - 8,80	5,50 - 10,00	-	19,00	2,50	15,00	S	45	50
0501 121 190	8,05 - 8,30	2,00 - 7,50	8,10	20,00	3,20	13,00	S	46	50
0500 919 2	8,30	3,50 - 7,00	8,30	12,00	2,50	10,00	S	47	50
0501 105 084	8,70 - 9,00	2,00	8,80	18,00	3,50	13,50	S	48	50
0501 101 627	14,00	2,50	13,00	20,00	2,80	17,40	S	49	25



Art. No. 0500 941 2
Fig. No.: 1

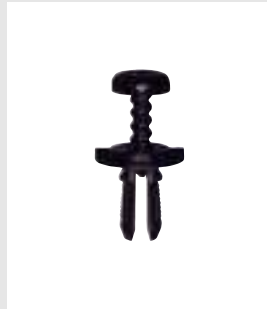

Art. No. 0500 290 1
Fig. No.: 2



Art. No. 0501 121 139
Fig. No.: 3

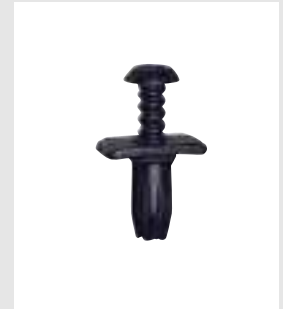

Art. No. 0500 292 9
Fig. No.: 4



Art. No. 0500 785 084
Fig. No.: 5



Art. No. 0501 167 027
Fig. No.: 6



Art. No. 0501 121 141
Fig. No.: 7



Art. No. 0500 295 6
Fig. No.: 8



Art. No. 0501 104 039
Fig. No.: 9



Art. No. 0501 302 003
Fig. No.: 10



Art. No. 0500 135 820
Fig. No.: 11



Art. No. 0501 301 001
Fig. No.: 12

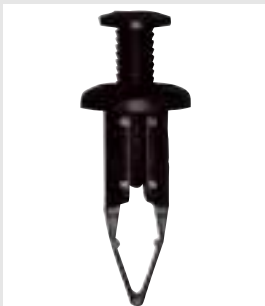

Art. No. 0501 130 052
Fig. No.: 13



Art. No. 0500 135 110
Fig. No.: 14

Threaded Blind Rivet

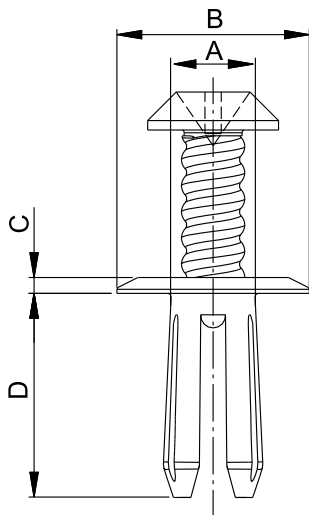

Art. No.	Att. hole	Att. thickness	Drive	A	B	C	D	Color	Fig.	P. Qty.
0500 941 2	4,50 - 5,30	3,50 - 5,00	Phillips head	4,50	12,00	1,50	11,20	S	1	25
0500 290 1	4,90 x 4,90	- 1,80	Phillips head	4,90 x 4,90	12,00	1,60	11,00	S	2	25
0501 121 139	5,05 - 5,25	3,80	Phillips head	5,05 - 5,25	12,00	1,50	11,70	S	3	25
0500 292 9	5,60 - 5,80	0,50 - 3,00	Phillips head	6,00	-	2,00	12,00	S	4	50
0500 785 084	6,00	1,50	Phillips head	-	18,00	2,50	11,50	S	5	25
0501 167 027	6,20	3,00 - 5,80	Torx	6,20	12,00	1,50	9,00	S	6	50
0501 121 141	6,20	5,80 - 10,00	Torx	5,80	12,10	1,50	14,20	S	7	25
0500 295 6	6,20 - 6,30	- 10,00	Phillips head	6,20	17,00	1,60	15,20	S	8	25
0501 104 039	6,30 - 6,90	3,50 - 5,10	Phillips head	6,30	16,30	1,60	11,30	S	9	50
0501 302 003	7,10 - 11,00	1,00 - 3,00	Slotted	7,80 x 6,80	11,00	1,50	9,60	S	10	25
0500 135 820	8,20 - 8,40	2,00	Phillips head	8,20	20,00	1,30	14,00	S	11	50
0501 301 001	8,50 x 8,50	0,70	Phillips head	-	23,50	3,50	15,00	S	12	25
0501 130 052	8,70	-	Phillips head	8,70	15,00	3,00	26,50	S	13	10
0500 135 110	11,00	11,00	Phillips head	11,00	25,00	2,50	13,00	G	14	25



Art. No. 0501 101 354
Fig. No.: 1



Art. No. 0501 141 007
Fig. No.: 2

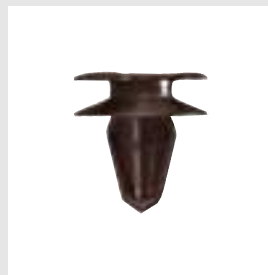

Art. No. 0500 136 31
Fig. No.: 3



Art. No. 0500 136 88
Fig. No.: 4

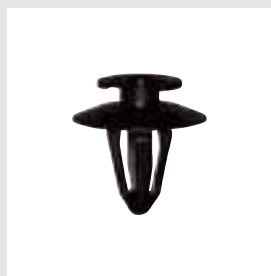

Art. No. 0501 104 085
Fig. No.: 5



Art. No. 0501 101 351
Fig. No.: 6



Art. No. 0500 129 54
Fig. No.: 7



Art. No. 0501 105 085
Fig. No.: 8



Art. No. 0501 105 400
Fig. No.: 9



Art. No. 0501 104 046
Fig. No.: 10



Art. No. 0500 136 76
Fig. No.: 11



Art. No. 0501 105 123
Fig. No.: 12

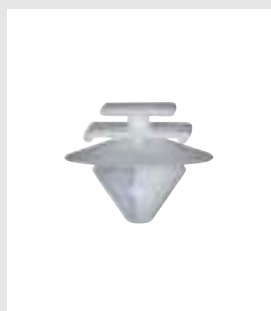

Art. No. 0501 121 134
Fig. No.: 13

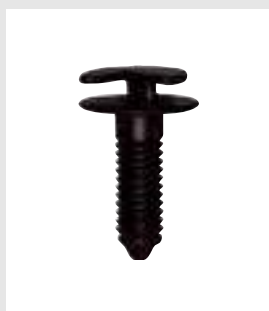

Art. No. 0501 321 003
Fig. No.: 14



Art. No. 0501 121 136
Fig. No.: 15



Art. No. 0500 680 8
Fig. No.: 16



Art. No. 0500 671
Fig. No.: 17



Art. No. 0501 101 636
Fig. No.: 18



Art. No. 0501 101 659
Fig. No.: 19



Art. No. 0501 101 350
Fig. No.: 20



Art. No. 0501 102 024
Fig. No.: 21



Art. No. 0501 102 010
Fig. No.: 22



Art. No. 0501 101 308
Fig. No.: 23



Art. No. 0500 405 0
Fig. No.: 24



Art. No. 0501 121 133
Fig. No.: 25



Art. No. 0501 121 132
Fig. No.: 26



Art. No. 0501 121 129
Fig. No.: 27

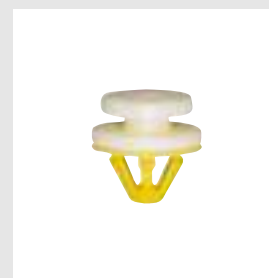

Art. No. 0501 167 021
Fig. No.: 28



Art. No. 0501 167 022
Fig. No.: 29



Art. No. 0501 167 019
Fig. No.: 30



Art. No. 0501 121 192
Fig. No.: 31

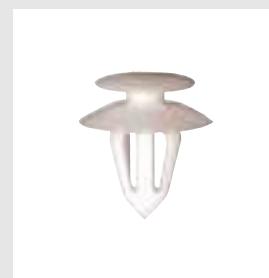

Art. No. 0501 103 011
Fig. No.: 32

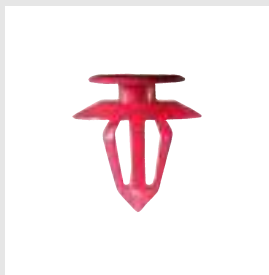

Art. No. 0501 103 012
Fig. No.: 33



Art. No. 0501 104 045
Fig. No.: 34



Art. No. 0501 104 107
Fig. No.: 35

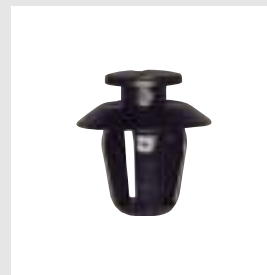

Art. No. 0501 121 137
Fig. No.: 36

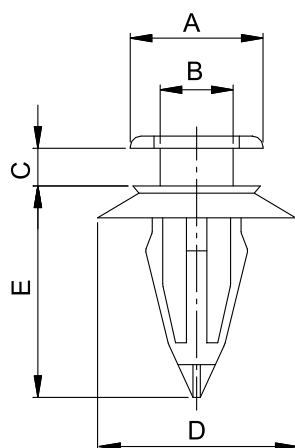

Art. No.	Att. hole	Att. thickness	A	B	C	D	E	Color	Fig.	P. Qty.
0501 101 354	5,00	2,20	12,60	7,00	2,20	14,90	17,30	N	1	50
0501 141 007	7,10 - 7,35	0,90	10,00	4,00	2,80	14,75	10,30	S	2	10
0500 136 31	7,30 - 7,50	0,70 - 0,90	17,00	7,20	1,90	17,00	14,80	S	3	100
0500 136 88	7,50 - 7,70	0,88	13,00	6,00	2,50	18,00	12,70	N	4	100
0501 104 085	7,50 - 7,80	1,00 - 1,50	11,50	5,50	2,50	18,00	13,00	N	5	10
0501 101 351	7,80 - 8,00	0,70 - 1,00	13,50	6,00	1,50	18,00	16,40	BR	6	100
0500 129 54	7,80 - 8,00	0,90	13,70	5,90	2,50 - 3,00	18,00	16,40	S	7	50
0501 105 085	7,80 - 8,00	1,40 - 1,80	15,60	5,70	2,50	18,00	14,10	N	8	25
0501 105 400	7,90 - 8,00	0,80 - 1,00	14,50	6,00	2,70	18,00	16,40	N	9	100
0501 104 046	7,90 - 8,00	0,88 - 1,00	13,10	5,90	2,20 - 2,50	18,00	13,20	N	10	50
0500 136 76	7,90 - 8,00	0,88 - 1,00	15,10	6,00	2,20 - 2,50	18,00	13,70	GR	11	50
0501 105 123	7,90 - 8,00	2,00 - 2,30	14,50	6,00	2,70	18,00	17,50	Y	12	100
0501 121 134	8,00	0,67 - 1,00	10,00	2,95	1,15	20,00	12,80	W	13	25
0501 321 003	8,00	0,70 - 0,80	13,00	-	2,40	17,00	22,90	S	14	25
0501 121 136	8,00	0,70 - 2,00	-	2,95	2,20	12,00	12,30	S	15	50
0500 680 8	8,00	0,80	13,70	-	2,80	17,00	11,90	W	16	25
0500 671	8,00	0,80	13,70	5,00	2,40	17,00	-	N	17	25
0501 101 636	8,00 - 8,20	0,60 - 1,40	15,00	5,40	1,30 - 1,50	18,00	15,00	N	18	50
0501 101 659	8,00 - 8,20	0,70 - 1,20	10,00	-	-	17,50	-	Y	19	100
0501 101 350	8,00 - 8,20	2,00	12,50	7,00	0,75	12,50	13,95	N	20	50
0501 102 024	8,00 - 8,40	0,70 - 1,00	13,20	5,50	2,10	18,50	-	N	21	25
0501 102 010	8,00 - 8,40	0,70 - 1,00	13,20	5,50	2,70	18,50	-	S	22	100
0501 101 308	8,00 - 8,50	0,80 - 1,20	13,40	6,00	3,00	18,00	16,80	N	23	50
0500 405 0	8,10 - 8,50	0,70 - 1,00	13,20	5,50	2,30	18,00	14,60	N	24	100
0501 121 133	8,20	0,60 - 0,80	15,00	4,60	2,60	16,40	15,60	N	25	50
0501 121 132	8,20	0,67 - 0,97	13,00	4,50	2,70	-	-	N	26	25
0501 121 129	8,20	0,70	12,00	5,00	2,80	18,00	16,50	N	27	50
0501 167 021	8,20	0,70 - 1,50	12,50	6,00	2,20	14,90	10,50	N	28	25
0501 167 022	8,20	0,70 - 1,50	12,50	6,00	2,20	14,90	10,50	N	29	25
0501 167 019	8,20	0,70 - 1,50	12,50	6,00	2,20	14,90	13,70	N	30	100
0501 121 192	8,20	0,70 - 2,50	12,50	6,00	2,20	16,00	-	N	31	10
0501 103 011	8,50 - 9,00	0,80 - 1,50	12,80	4,90	2,50	17,00	15,00	W	32	100
0501 103 012	8,50 - 9,00	0,80 - 1,50	12,80	4,90	2,50	17,00	15,00	R	33	50
0501 104 045	8,60 - 8,80	0,90 - 2,00	13,20	5,90	2,30	20,00	15,10	N	34	50
0501 104 107	9,30 - 9,50	0,80 - 1,00	13,50	6,00	2,50 - 2,70	18,00	16,40	GR	35	50
0501 121 137	9,50	0,80	10,00	-	2,80	18,00	14,90	S	36	100

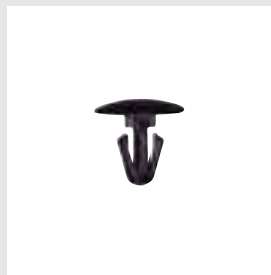

Art. No. 0501 121 108
Fig. No.: 1



Art. No. 0501 121 110
Fig. No.: 2

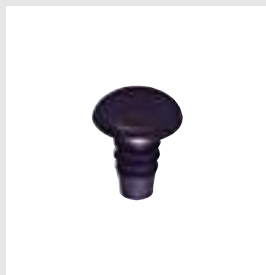

Art. No. 0500 127 09
Fig. No.: 3

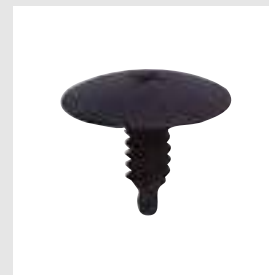

Art. No. 0501 101 620
Fig. No.: 4

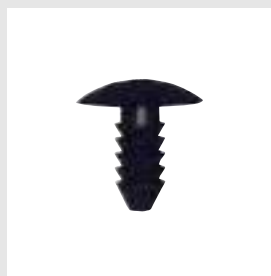

Art. No. 0500 132 170
Fig. No.: 5

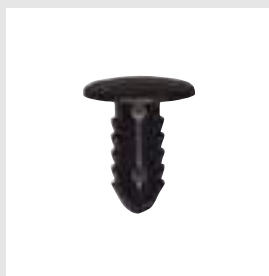

Art. No. 0500 921 9
Fig. No.: 6



Art. No. 0501 121 104
Fig. No.: 7

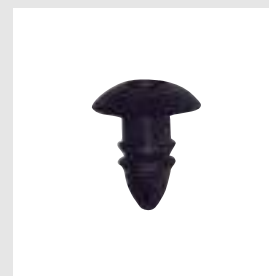

Art. No. 0501 167 001
Fig. No.: 8



Art. No. 0501 106 150
Fig. No.: 9

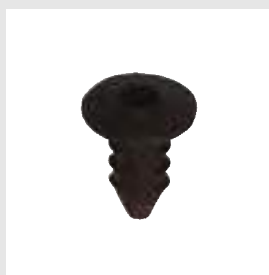

Art. No. 0501 106 201
Fig. No.: 10

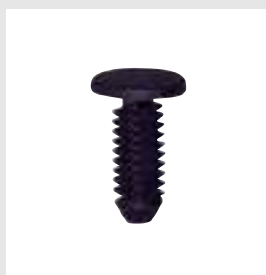

Art. No. 0500 682 9
Fig. No.: 11

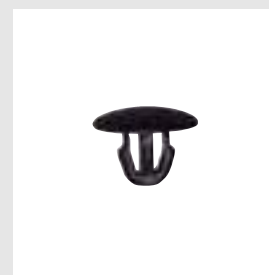

Art. No. 0501 106 203
Fig. No.: 12



Art. No. 0501 167 004
Fig. No.: 13



Art. No. 0501 167 007
Fig. No.: 14



Art. No. 0501 105 121
Fig. No.: 15

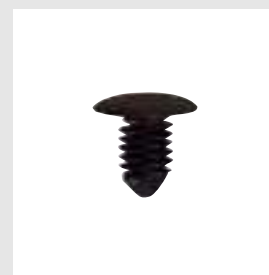

Art. No. 0500 939 6
Fig. No.: 16



Art. No. 0500 132 300
Fig. No.: 17



Art. No. 0500 940 5
Fig. No.: 18



Art. No. 0501 106 066
Fig. No.: 19

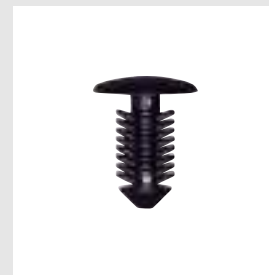

Art. No. 0500 939 5
Fig. No.: 20



Art. No. 0500 025 206
Fig. No.: 21

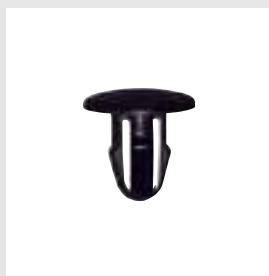

Art. No. 0500 8
Fig. No.: 22

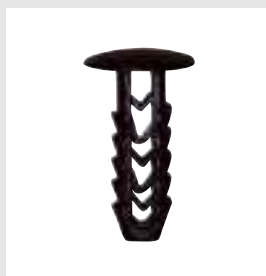

Art. No. 0500 025 459
Fig. No.: 23

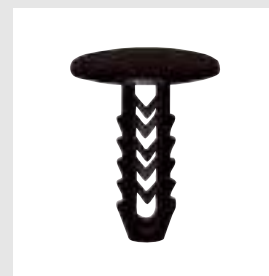

Art. No. 0500 011 58
Fig. No.: 24



Art. No. 0500 402 9
Fig. No.: 25



Art. No. 0501 321 001
Fig. No.: 26

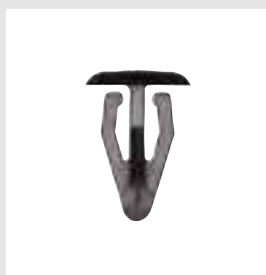

Art. No. 0500 917 0
Fig. No.: 27

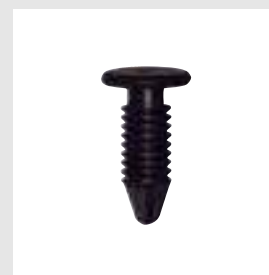

Art. No. 0501 121 103
Fig. No.: 28



Art. No. 0501 103 073
Fig. No.: 29



Art. No. 0501 103 077
Fig. No.: 30

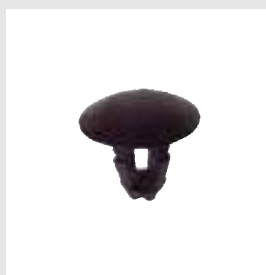

Art. No. 0501 105 082
Fig. No.: 31

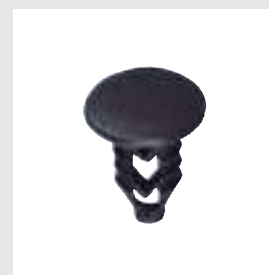

Art. No. 0500 025 205
Fig. No.: 32

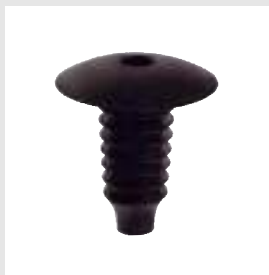

Art. No. 0501 105 601
Fig. No.: 33

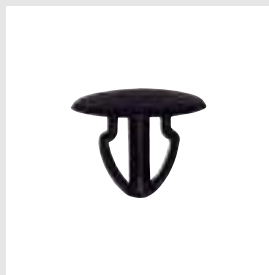

Art. No. 0500 125 51
Fig. No.: 34

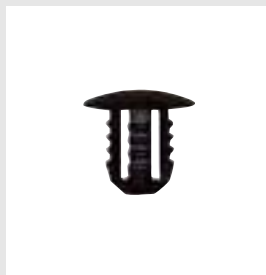

Art. No. 0501 102 022
Fig. No.: 35

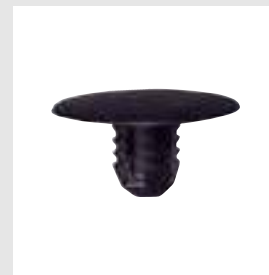

Art. No. 0501 102 021
Fig. No.: 36

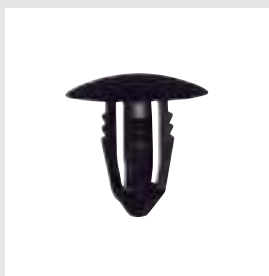

Art. No. 0500 145 45
Fig. No.: 37

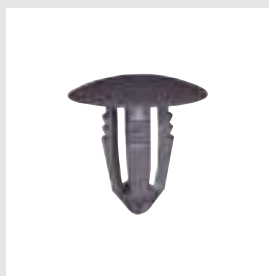

Art. No. 0501 102 023
Fig. No.: 38

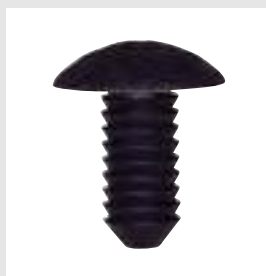

Art. No. 0500 132 200
Fig. No.: 39



Art. No. 0500 133 47
Fig. No.: 40



Art. No. 0501 167 005
Fig. No.: 41



Art. No. 0501 167 002
Fig. No.: 42

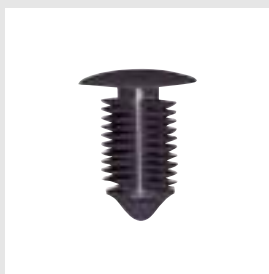

Art. No. 0500 680 7
Fig. No.: 43

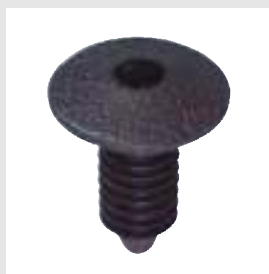

Art. No. 0500 132 03
Fig. No.: 44



Art. No. 0501 101 343
Fig. No.: 45

Cover plugs

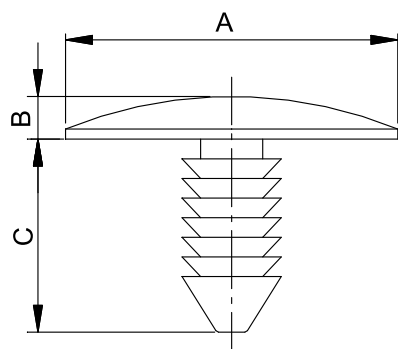

Art. No.	Att. hole	Att. thickness	A	B	C	Color	Fig.	P. Qty.
0501 121 108	4,70	3,00	12,00	1,75	10,00	S	1	25
0501 121 110	5,00 - 8,00	2,50	8,00 x 17,00	2,00	9,40	S	2	50
0500 127 09	5,80 - 6,00	3,60 - 7,40	12,00	2,00	12,00	S	3	50
0501 101 620	6,00 - 6,20	2,00 - 10,00	23,00	3,00	15,00	S	4	50
0500 132 170	6,00 - 6,20	3,50 - 11,00	17,00	3,00	15,00	S	5	50
0500 921 9	6,00 - 6,50	3,00 - 11,00	14,00	2,00	15,00	S	6	25
0501 121 104	6,20	0,80 - 3,00	20,00	1,50	10,00	S	7	50
0501 167 001	6,40 - 6,70	7,10 - 8,10	14,00	3,00	14,60	S	8	100
0501 106 150	6,50 - 6,80	6,00 - 15,00	22,00	4,00	20,00	S	9	25
0501 106 201	6,50 - 7,00	2,00 - 10,50	14,80	2,00	16,00	S	10	100
0500 682 9	6,50	-	12,50	1,80	17,20	S	11	50
0501 106 203	6,50 - 7,00	3,00	14,00	2,00	7,00	S	12	100
0501 167 004	6,70	0,67	25,00	2,00	12,00	S	13	100
0501 167 007	6,70	0,80 - 5,00	20,00	2,20	15,80	S	14	50
0501 105 121	7,00 - 7,05	2,50 - 17,00	14,00	2,00	25,00	S	15	100
0500 939 6	7,00 - 7,20	3,00 - 7,00	14,00	1,60	12,00	S	16	25
0500 132 300	7,00 - 7,20	7,50 - 22,50	30,00	4,00	30,00	S	17	50
0500 940 5	7,00 - 7,40	0,70 - 11,00	18,00	2,00	22,10	S	18	25
0501 106 066	7,00	3,50 - 14,50	16,00	2,00	17,00	G	19	50
0500 939 5	7,20 - 7,60	3,00 - 10,00	14,00	2,00	15,00	S	20	50
0500 025 206	7,50	3,00 - 12,00	15,00	2,00	17,50	S	21	50
0500 8	7,50	5,00	14,50	2,00	12,00	S	22	50
0500 025 459	7,50	5,50 - 17,50	15,00	2,00	22,50	S	23	50
0500 011 58	7,50	6,00 - 18,00	15,00	2,00	23,00	S	24	25
0500 402 9	7,50 - 7,80	3,00 - 12,00	28,00	4,00	14,00	S	25	100
0501 321 001	7,50 - 8,00	2,00 - 15,00	17,00	3,00	26,00	S	26	25
0500 917 0	7,80 - 8,00	2,00 - 4,50	14,00	2,00	20,00	S	27	50
0501 121 103	8,00	2,90 - 8,00	12,00	2,00	16,80	S	28	50
0501 103 073	8,00	3,50 - 11,00	14,00	2,00	15,50	S	29	50
0501 103 077	8,00	3,50 - 11,00	14,00	2,00	15,50	G	30	50
0501 105 082	8,00 - 8,40	2,80 - 3,55	17,00	2,50	12,50	S	31	50
0500 025 205	8,00 - 8,50	3,00 - 10,50	16,00	2,00	17,00	S	32	50
0501 105 601	8,00 - 8,50	3,00 - 14,00	20,00	2,75	20,00	S	33	25
0500 125 51	8,20 - 8,40	2,50	18,00	-	-	S	34	25
0501 102 022	8,40 - 8,60	2,00 - 6,00	15,00	2,00	11,70	S	35	25
0501 102 021	8,40 - 8,60	2,90 - 6,90	25,00	2,00	11,70	S	36	50
0500 145 45	8,40 - 8,62	2,70 - 6,00	18,00	2,00	15,60	S	37	25
0501 102 023	8,40 - 8,65	0,70 - 1,50	18,00	2,50	15,60	G	38	50
0500 132 200	9,50 - 9,70	1,50 - 17,00	22,00	5,50	21,50	S	39	50
0500 133 47	10,00	3,50 - 15,50	21,50	2,00	22,00	S	40	25
0501 167 005	10,20	2,00 - 13,00	35,00	4,00	22,00	S	41	50
0501 167 002	10,20 - 10,70	0,60 - 5,00	35,00	4,00	21,30	S	42	25
0500 680 7	10,40 - 11,40	3,00 - 10,20	16,00	2,00	19,00	G	43	25

Cover plugs

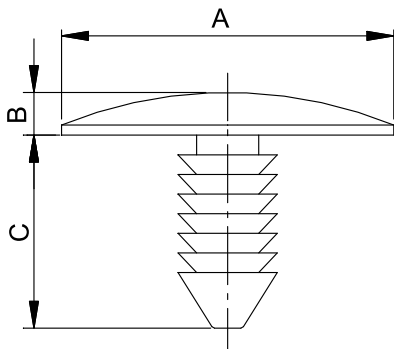

Art. No.	Att. hole	Att. thickness	A	B	C	Color	Fig.	P. Qty.
0500 132 03	11,00	5,00 - 19,00	24,00	3,40	25,00	S	44	25
0501 101 343	18,00	1,50 - 2,50	22,00	2,50	8,50	S	45	100

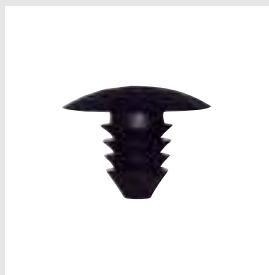

Art. No. 0501 104 105
 Orig. No.: 191867199
 19186719901C
 Fig. No.: 1

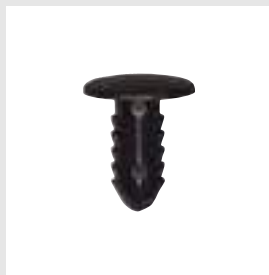

Art. No. 0500 921 9
 Orig. No.: 82386320301C
 Fig. No.: 2

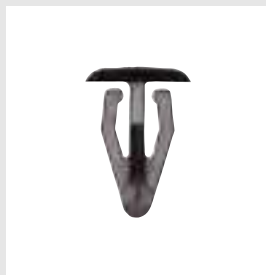

Art. No. 0500 917 0
 Orig. No.: 80186729901C
 801867299041
 Fig. No.: 3

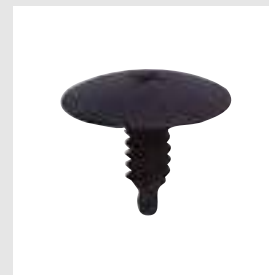

Art. No. 0501 101 620
 Orig. No.: 1H0819055B01C
 Eurocode: 8541ASCHB1B
 Fig. No.: 4



Art. No. 0501 101 621
 Orig. No.: 1H0837719
 Fig. No.: 5



Art. No. 0501 101 343
 Orig. No.: 1H0837111AB41
 Fig. No.: 6



Art. No. 0501 101 344
 Orig. No.: 1H586384901C
 Fig. No.: 7



Art. No. 0501 101 345
 Orig. No.: 357867646
 3578676469B9
 Fig. No.: 8



Art. No. 0500 133
 Orig. No.:
 Fig. No.: 9



Art. No. 0501 101 622
 Orig. No.: N90634901
 Fig. No.: 10

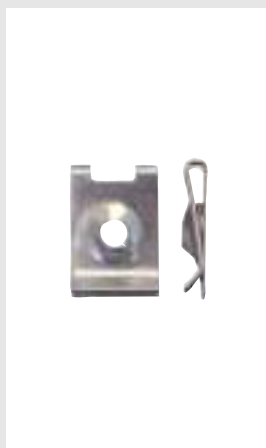

Art. No. 0500 113 62
 Orig. No.: N0154292
 Fig. No.: 11



Art. No. 0500 115 22
 Orig. No.:
 Fig. No.: 12



Art. No. 0500 113 69
 Orig. No.: 803821117
 Fig. No.: 13



Art. No. 0500 114 03
 Orig. No.: 311821161
 Fig. No.: 14

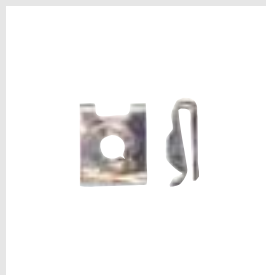

Art. No. 0500 136 58
 Orig. No.: N90048801
 Fig. No.: 15



Art. No. 0501 101 666
 Orig. No.: N90698701
 N90698703
 Fig. No.: 16



Art. No. 0501 101 645
 Orig. No.: N90356203
 Fig. No.: 17



Art. No. 0501 101 646
 Orig. No.: N90168604
 Fig. No.: 18

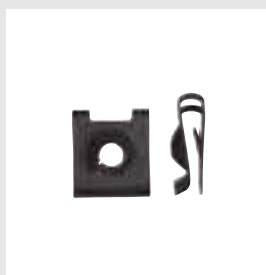

Art. No. 0500 136 29
 Orig. No.: N90057901
 Fig. No.: 19

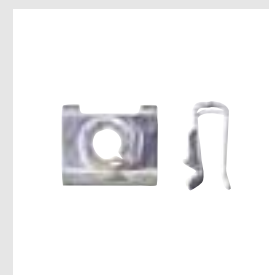

Art. No. 0500 137 04
 Orig. No.: N90074301
 Fig. No.: 20

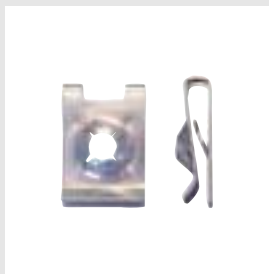

Art. No. 0500 139 56
 Orig. No.: N90094201
 Fig. No.: 21



Art. No. 0501 101 623
 Orig. No.: 4A0805163
 Fig. No.: 22



Art. No. 0501 101 346
 Orig. No.: 8D0805960
 Fig. No.: 23

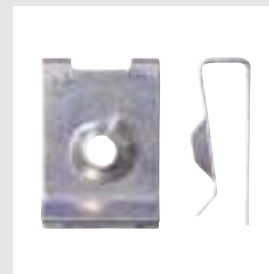

Art. No. 0500 135 76
 Orig. No.: N90049701
 Fig. No.: 24

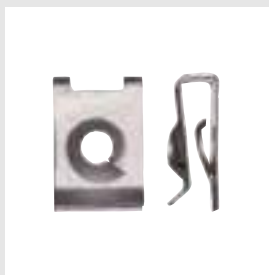

Art. No. 0501 101 647
 Orig. No.: N0154373
 Fig. No.: 25



Art. No. 0501 101 648
 Orig. No.: N0154391
 Fig. No.: 26



Art. No. 0501 101 649
 Orig. No.: N90335004
 N90335006
 Fig. No.: 27



Art. No. 0501 101 624
 Orig. No.: N90796501
 Fig. No.: 28

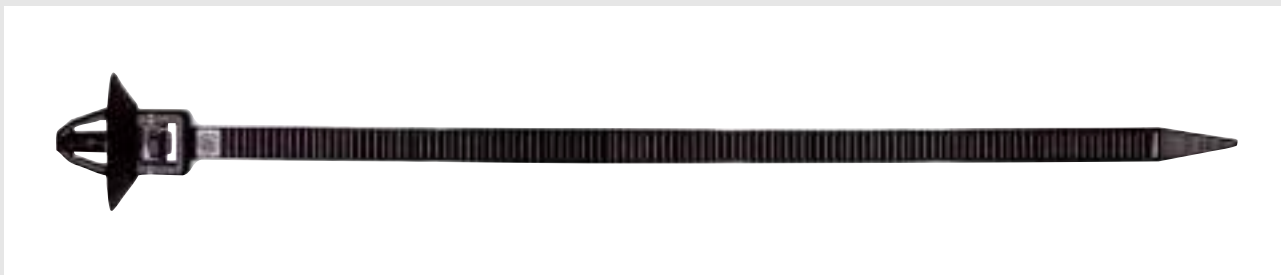

Art. No. 0500 238 3
 Orig. No.: N90205501
 Fig. No.: 29



Art. No. 0501 101 650
 Orig. No.: 811971850
 Fig. No.: 30

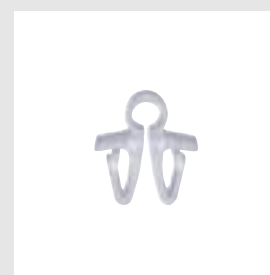

Art. No. 0501 101 651
 Orig. No.: 4A0823570
 Fig. No.: 31



Art. No. 0501 101 322
 Orig. No.: 171201969
 Fig. No.: 32



Art. No. 0500 143 00
 Orig. No.: 113,857,117B
 Fig. No.: 33



Art. No. 0500 523 14
 Orig. No.: N10259301
 1L0853934
 Fig. No.: 34



Art. No. 0501 101 652
 Orig. No.: N0385011
 Fig. No.: 35



Art. No. 0500 127 10
 Orig. No.: N0385012
 Fig. No.: 36



Art. No. 0500 148 02
 Orig. No.: 321,853,139A
 Fig. No.: 37



Art. No. 0501 103 035
 Orig. No.: N10219501
 N10219502
 Fig. No.: 38

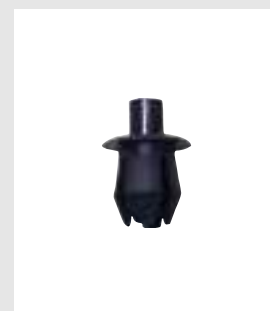

Art. No. 0500 937 7
 Orig. No.: N0385501
 Fig. No.: 39



Art. No. 0501 101 000
 Orig. No.: 16186729901C
 N038549101C
 Fig. No.: 40



Art. No. 0501 104 038
 Orig. No.: N10032301
 Fig. No.: 41



Art. No. 0501 104 122
 Orig. No.: 171885767
 Fig. No.: 42



Art. No. 0500 128 21
 Orig. No.: 481,853,577A
 Fig. No.: 43



Art. No. 0501 101 627
 Orig. No.: 8L0807300
 Fig. No.: 44



Art. No. 0501 101 628
 Orig. No.: N90229301
 Fig. No.: 45



Art. No. 0501 101 629
 Orig. No.: 4D0807300B
 Fig. No.: 46



Art. No. 0501 101 347
 Orig. No.: 443807269
 Fig. No.: 47

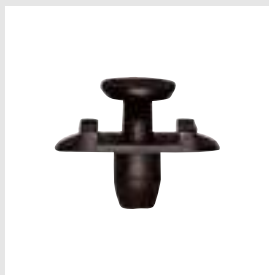

Art. No. 0501 101 348
 Orig. No.: 8L3837199B
 Fig. No.: 48



Art. No. 0501 105 064
 Orig. No.: N90359101
 Fig. No.: 49

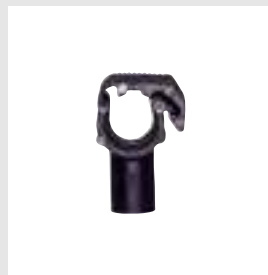

Art. No. 0501 101 653
 Orig. No.: N10446801
 Fig. No.: 50

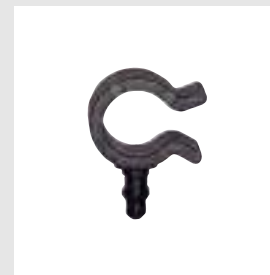

Art. No. 0501 101 654
 Orig. No.: N10275101
 Fig. No.: 51

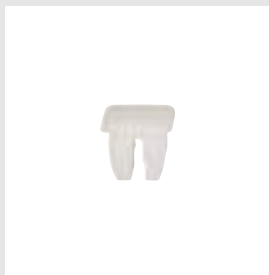

Art. No. 0501 121 123
 Orig. No.: 441035555
 Fig. No.: 52



Art. No. 0501 102 006
 Orig. No.: 4D0868637
 Fig. No.: 53

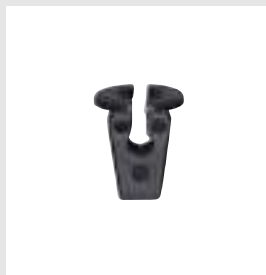

Art. No. 0500 879 32
 Orig. No.: 867809966
 Fig. No.: 54

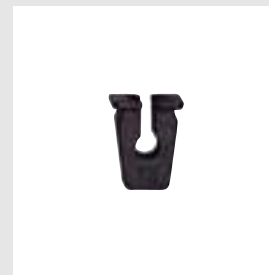

Art. No. 0500 879 33
 Orig. No.: 811807577F
 Fig. No.: 55

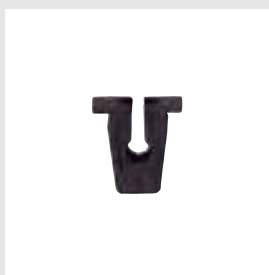

Art. No. 0501 101 001
 Orig. No.: 811807577C
 Fig. No.: 56



Art. No. 0500 142 24
 Orig. No.: 321,813,998A
 Fig. No.: 57



Art. No. 0501 101 349
 Orig. No.: 165827592
 Fig. No.: 58

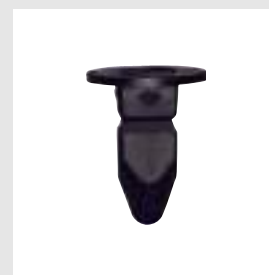

Art. No. 0501 101 229
 Orig. No.: 357827998
 Fig. No.: 59



Art. No. 0501 101 230
 Orig. No.: 357868143
 Fig. No.: 60

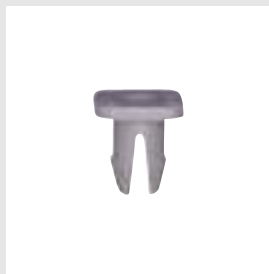

Art. No. 0501 101 232
 Orig. No.: N90535301
 Fig. No.: 61

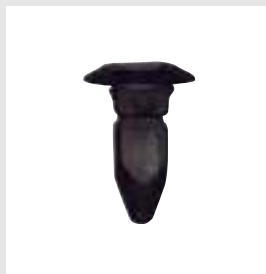

Art. No. 0501 101 233
 Orig. No.: N90821401
 Fig. No.: 62

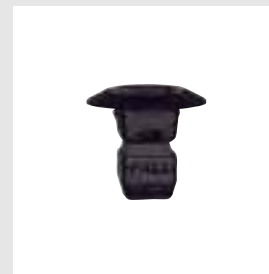

Art. No. 0501 101 319
 Orig. No.: N90833801
 Fig. No.: 63

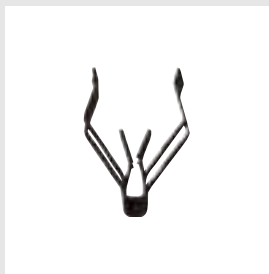

Art. No. 0501 101 655
 Orig. No.: 1J0858137A
 Fig. No.: 64

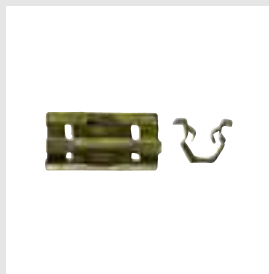

Art. No. 0501 101 656
 Orig. No.: 3B0867190
 Fig. No.: 65



Art. No. 0500 117 07
 Orig. No.: 113853615
 Fig. No.: 66



Art. No. 0500 122 33
 Orig. No.: 113,853,615A
 Fig. No.: 67

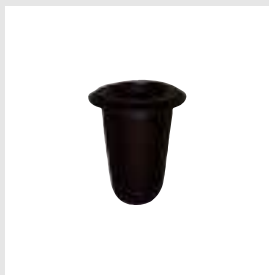

Art. No. 0500 117 75
 Orig. No.: 113,857,219A
 Fig. No.: 68

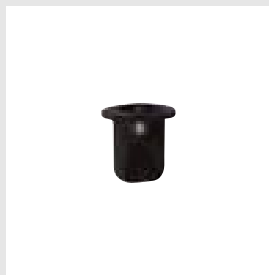

Art. No. 0501 103 044
 Orig. No.: 171,853,615A
 Fig. No.: 69



Art. No. 0501 101 318
 Orig. No.: 1H0853586
 Fig. No.: 70



Art. No. 0501 101 657
 Orig. No.: 211853615
 Fig. No.: 71

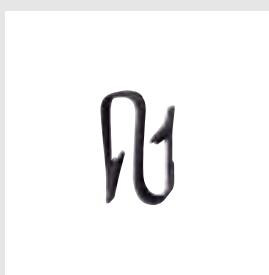

Art. No. 0501 101 658
 Orig. No.: N90323501
 Fig. No.: 72



Art. No. 0501 101 659
 Orig. No.: 7M0867299K
 Fig. No.: 73



Art. No. 0500 129 54
 Orig. No.: 823867299
 Fig. No.: 74



Art. No. 0501 101 350
 Orig. No.: 171,807,249A
 Fig. No.: 75



Art. No. 0501 101 308
 Orig. No.: 171,867,299B
 Fig. No.: 76



Art. No. 0501 101 219
 Orig. No.: 3B0868243
 Fig. No.: 77



Art. No. 0501 101 635
 Orig. No.: 357,853,585A
 Fig. No.: 78



Art. No. 0501 101 660
 Orig. No.: 443867299
 Fig. No.: 79



Art. No. 0501 101 636
 Orig. No.: 6X0867300A
 Fig. No.: 80



Art. No. 0501 101 351
 Orig. No.: 893867290
 Fig. No.: 81

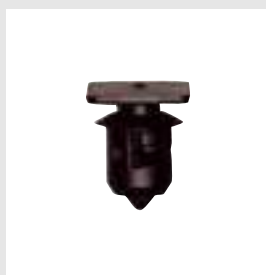

Art. No. 0501 101 661
 Orig. No.: 4D0867299D
 Fig. No.: 82



Art. No. 0501 101 311
 Orig. No.: 1H0868243B
 1H0868243
 Fig. No.: 83



Art. No. 0501 101 638
Orig. No.: 6N0868243A
Fig. No.: 84



Art. No. 0501 101 662
Orig. No.: 6Q0868243
Fig. No.: 85



Art. No. 0501 101 663
Orig. No.: 8E0868243
Fig. No.: 86

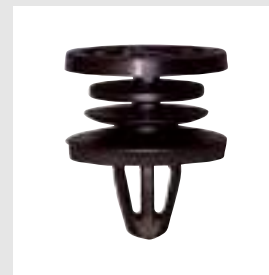

Art. No. 0501 101 664
Orig. No.: 5X0867299
Fig. No.: 87



Art. No. 0501 101 352
Orig. No.: 6K0868243
Fig. No.: 88



Art. No. 0501 101 353
Orig. No.: 1H0868246B
Fig. No.: 89



Art. No. 0501 101 354
Orig. No.: 3B0867333
Fig. No.: 90



Art. No. 0501 101 355
Orig. No.: 3C0867333
Fig. No.: 91



Art. No. 0501 121 130
Orig. No.: 8E9867299
Eurocode: 2730ASCTS1B
Fig. No.: 92



Art. No. 0500 116 39
Orig. No.: N0143893
N143893
Fig. No.: 93



Art. No. 0500 123 301
Orig. No.: 113853585C
Fig. No.: 94



Art. No. 0501 101 003
Orig. No.: 191,853,733A
6U0853733
Eurocode: 7603ASCH
Fig. No.: 95



Art. No. 0501 101 639
Orig. No.: 1H0853585
Fig. No.: 96



Art. No. 0501 101 206
Orig. No.:
Fig. No.: 97



Art. No. 0501 101 207

Orig. No.:
Fig. No.: 98

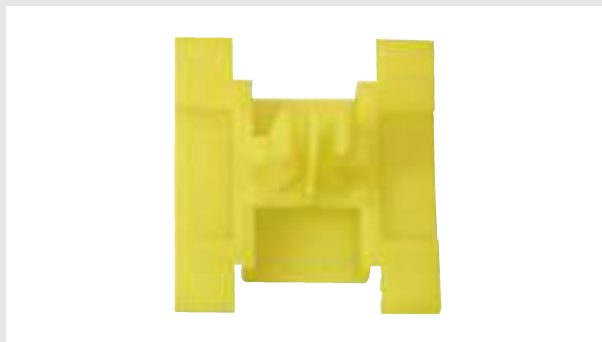

Art. No. 0501 101 640

Orig. No.: 1H0853585B
Fig. No.: 99



Art. No. 0501 101 208

Orig. No.: 1H0853733B
Eurocode: 8541ASCH
Fig. No.: 100



Art. No. 0501 101 356

Orig. No.: 357867300
Fig. No.: 101



Art. No. 0501 101 357

Orig. No.: 8D0853909B
Fig. No.: 102

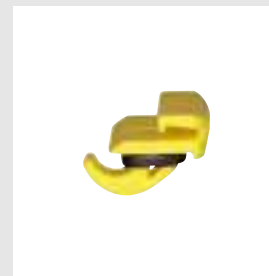

Art. No. 0501 301 003

Orig. No.: 1M0854541A
Eurocode: 7608ASCSS
Fig. No.: 103



Art. No. 0501 301 004

Orig. No.: 1M0854719A
Eurocode: 7608ASCSS1B
Fig. No.: 104



Art. No. 0501 101 641

Orig. No.: N10209005
Fig. No.: 105

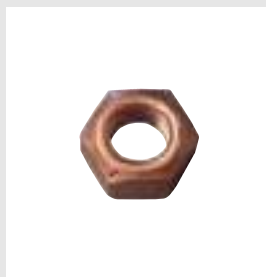

Art. No. 0501 101 642

Orig. No.: N0221464
Fig. No.: 106

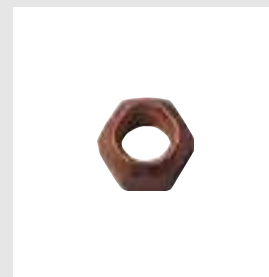

Art. No. 0501 101 643

Orig. No.: N90085001
Fig. No.: 107

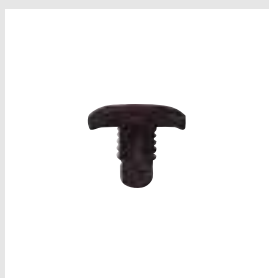

Art. No. 0500 147 20

Orig. No.: 251823717
Fig. No.: 108



Art. No. 0501 101 204

Orig. No.: 1H0823717
Fig. No.: 109



Art. No. 0501 101 358

Orig. No.: 6Q0853147
Fig. No.: 110

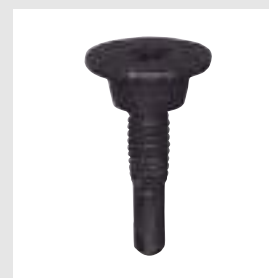

Art. No. 0501 101 338

Orig. No.: 6N0807199
N90740701
Fig. No.: 111



Art. No. 0362 312 15
 Orig. No.: 3A0601139
 Fig. No.: 112



Art. No. 0362 014 15
 Orig. No.: 8D0601139D
 Fig. No.: 113



Art. No. 0501 301 001
 Orig. No.: 1H0819055C01C
 Eurocode: 8541ASCHB
 Fig. No.: 114

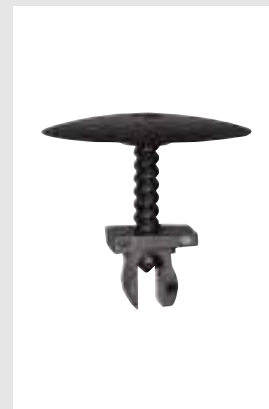

Art. No. 0501 301 002
 Orig. No.: 6K0819285B41
 Eurocode: 7609ASSHB
 Fig. No.: 115



Art. No. 0501 101 301
 Orig. No.: 4A0805121A
 Fig. No.: 116

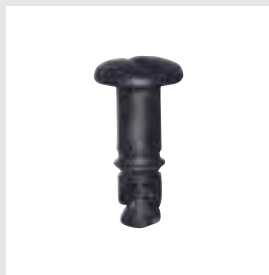

Art. No. 0501 101 341
 Orig. No.: 4A0805121B
 Fig. No.: 117



Art. No. 0501 101 300
 Orig. No.: 4A0805121C
 Fig. No.: 118



Art. No. 0501 101 339
 Orig. No.: 8D0805121B
 Fig. No.: 119



Art. No. 0501 101 321
 Orig. No.: 8E0805121A
 Fig. No.: 120



Art. No. 0501 101 665
 Orig. No.: 4F0805121
 Fig. No.: 121



Art. No. 0501 101 340
 Orig. No.: 8D0805121
 Fig. No.: 122

Index sorted by Art. No.						
Art. No.	Orig. No.	Eurocode	Designation	Car type	Fig.	P. Qty.
0362 014 15	8D0601139D		WHEEL BOLT GEOMET BLACK M14X1.5X25.5 17 MM *	A80, A100, A200, A2, A3, A4, A6,A8, AUDI TT, NEW BEETLE, BORA, GOLF, PAS- SAT, POLO, JETTA	113	50
0362 312 15	3A0601139		WHEEL BOLT GALV. CLR. M12X1.5X22.5 17 MM *	AUDI 80, A2, CADDY, SCIROCCO, GOLF, LUPO, PASSAT, POLO, JETTA	112	50
0500 113 62	N0154292		SHEET-METAL NUT ST 4.2 MM GALV. CLR. PASSIV.	-	11	100
0500 113 69	803821117		SHEET-METAL NUT ST 6.3 MM GALV. CLR. PASSIV. MATT	AUDI 80, PASSAT, POLO, T3	13	100
0500 114 03	311821161		SHEET-METAL NUT ST 6.3 MM HALF GALV. CLR. PASSIV. MATT	UNIVERSAL	14	100
0500 115 22			SHEET-METAL NUT ST 4.8 MM GALV. CLR. PASSIV.	GOLF 3	12	100
0500 116 39	N0143893		PAPERBOARD CLIP GALV. CLR.	-	93	25
0500 116 39	N143893		PAPERBOARD CLIP GALV. CLR.	-	93	25
0500 117 07	113853615		GROMMET FOR LETTERING PE 181 CLR.	AUDI 80, AUDI 100, T3, SCIROCCO, GOLF, PASSAT, POLO	66	100
0500 117 75	113857219A		BLACK GROMMET	SCIROCCO, GOLF, PASSAT, POLO, JETTA	68	100
0500 122 33	113853615A		GROMMET PE LD COLORLESS	-	67	100
0500 123 301	113853585C		TRIM CLIP WITH RED RING	AUDI 80, SCIROCCO, GOLF, PASSAT, T3, JETTA	94	50
0500 127 10	N0385012		PLASTIC SPLIT RIVET PA6 BK	-	36	50
0500 128 21	481853577A		PLASTIC SPLIT RIVET PA66 NATURAL	A4, A6, PASSAT, POLO	43	25
0500 129 54	823867299		INTERIOR LINING CLIP PA 66 BLACK	AUDI 80, AUDI 100, AUDI 200, A6, A8, CADDY, SCIROC- CO, GOLF, PASSAT, POLO, T2, JETTA, TRANSPORTER	74	50
0500 133			ALUMIN./STEEL BLIND RIVET A2	-	9	50
0500 135 76	N90049701		SHEET-METAL NUT ST 4.8 MM GALV. CLR. PASSIV.	-	24	100
0500 136 29	N90057901		SHEET-METAL NUT ST 4.2 MM PHOSD. IMP.	-	19	100
0500 136 58	N90048801		SHEET-METAL NUT ST 3.5 MM GALV. CLR. PASSIV.	-	15	100
0500 137 04	N90074301		SHEET-METAL NUT ST 3.9 MM GALV.	-	20	100
0500 139 56	N90094201		SHEET-METAL NUT ST 4.8 MM GALV. CLR. PASSIV.	-	21	100
0500 142 24	321813998A		EXPANDING NUT PA 66 COLORLESS*	AUDI 80, AUDI 100, AUDI 200, GOLF, PASSAT, JETTA	57	50
0500 143 00	113857117B		BLACK PLASTIC SPLIT RIVET POM	T1, GOLF, PASSAT, AUDI 100	33	50
0500 147 20	251823717		DOOR SEAL CLIP PA 665 BLACK	SCIROCCO, GOLF, LUPO, POLO, SHARAN, T2, TRANS- PORTER, JETTA	108	100
0500 148 02	321853139A		PLASTIC SPLIT RIVET PA66 BLACK	GOLF, PASSAT, JETTA	37	25
0500 238 3	N90205501		CABLE TIE WITH BASE PA66 BLACK	AUDI 100, COUPÉ	29	25
0500 523 14	N10259301		PLASTIC SPLIT RIVET PA12 BLACK	A6, S6, SEAT LEON 2004	34	50
0500 523 14	110853934		PLASTIC SPLIT RIVET PA12 BLACK	A6, S6, SEAT LEON 2004	34	50
0500 879 32	867809966		EXPANDING NUT PA6 GF 30 BK	GOLF	54	50
0500 879 33	811807577F		EXPANDING NUT PA6 GF 30 BK	-	55	50
0500 917 0	80186729901C		COVER PLUG POM BLACK	GOLF, POLO, BORA, PASSAT, JETTA	3	50
0500 917 0	801867299041		COVER PLUG POM BLACK	GOLF, POLO, BORA, PASSAT, JETTA	3	50
0500 921 9	82386320301C		BLACK FIR-TREE CLIP	GOLF 88, PASSAT, POLO, AUDI 80, AUDI 100, A4, A6, A8	2	25

Index sorted by Art. No.						
Art. No.	Orig. No.	Eurocode	Designation	Car type	Fig.	P. Qty.
0500 937 7	N0385501		PLASTIC SPLIT RIVET PA 66 DARK GRAY	AUDI TT, BORA, CADDY, CORRADO, GOLF 1+2+3, JETTA, LT, NEW BEETLE, PASSAT, PHAETON, POLO, SHARAN, TOUAREG, TRANSPORTER, VENTO	39	100
0501 101 000	16186729901C		PLASTIC SPLIT RIVET PA66 BK	AUDI 80, AUDI 200, A4, NEW BEETLE, BORA, SCIROCCO, GOLF, PASSAT, POLO, JETTA, TRANSPORTER	40	100
0501 101 000	N038549101C		PLASTIC SPLIT RIVET PA66 BK	AUDI 80, AUDI 200, A4, NEW BEETLE, BORA, SCIROCCO, GOLF, PASSAT, POLO, JETTA, TRANSPORTER	40	100
0501 101 001	811807577C		EXPANDING NUT PA GF 30 BK	AUDI 80, AUDI 100, AUDI 200, A2, A3, A4, A6, A8, NEW BEETLE, BORA, SCIROCCO, GOLF, POLO, TRANSPORTER, JETTA	56	50
0501 101 003	191853733A	7603ASCH	CLEAR ROOF TRIM CLIP	CADDY, GOLF, PASSAT, POLO, JETTA	95	50
0501 101 003	6U0853733	7603ASCH	CLEAR ROOF TRIM CLIP	CADDY, GOLF, PASSAT, POLO, JETTA	95	50
0501 101 204	1H0823717		DOOR SEAL CLIP PA 66 BLACK	BORA, GOLF, LUPO, PASSAT, SHARAN, JETTA	109	100
0501 101 206			TRIM CLIP POM COLORLESS WITH GREEN GROMMET	-	97	25
0501 101 207			TRIM CLIP COLORLESS WITH GREEN GROMMET	-	98	25
0501 101 208	1H0853733B	8541ASCH	TRIM CLIP POM COLORLESS	GOLF, JETTA	100	50
0501 101 219	3B0868243		INTERIOR LINING CLIP VW POM BLACK	BORA, GOLF, PASSAT, TOLEDO, LEON, IBIZA	77	25
0501 101 229	357827998		EXPANDING NUT PA 6 BLACK	POLO 00 - 02, GOLF II, PASSAT, VENTO	59	50
0501 101 230	357868143		EXPANDING NUT PA 6 GRAY	NEW BEETLE, GOLF, PASSAT, POLO, JETTA, TRANSPORTER	60	50
0501 101 232	N90535301		GREY EXPANDING NUT	POLO 1995	61	50
0501 101 233	N90821401		EXPANDING NUT PA 6 BK	A2, A3, A4, A6, A8, TT, BORA, GOLF, LUPO, NEW BEETLE, PASSAT, POLO, TOUAREG	62	50
0501 101 300	4A0805121C		BLACK PLASTIC TURN-LOCK FASTENER	A4, A8	118	25
0501 101 301	4A0805121A		BLACK PLASTIC TURN-LOCK FASTENER	AUDI 80, AUDI 100, A3, A4, A6, A8, PASSAT	116	25
0501 101 308	171867299B		CLEAR INTERIOR LINING CLIP	-	76	50
0501 101 311	1H0868243B		CLEAR/BROWN INTERIOR LINING CLIP	GOLF III, GOLF IV, JETTA	83	25
0501 101 311	1H0868243		CLEAR/BROWN INTERIOR LINING CLIP	GOLF III, GOLF IV, JETTA	83	25
0501 101 318	1H0853586		GREEN GROMMET FOR TRIM CLIP VW	A3, BORA, SCIROCCO, GOLF, PASSAT, POLO, JETTA, TOUAREG	70	50
0501 101 319	N90833801		EXPANDING NUT PA 66 BLACK*	A3, A4, BORA, CADDY, GOLF, JETTA, LUPO, NEW BEETLE, PASSAT, PHAETON, POLO, TOURAN	63	50
0501 101 321	8E0805121A		TURN-LOCK FASTENER WITH SEAL 7.0 x 12.0	A4 01 - 03, A6	120	25

Index sorted by Art. No.						
Art. No.	Orig. No.	Eurocode	Designation	Car type	Fig.	P. Qty.
0501 101 322	171201969		PLASTIC NUT PA 6 GF 30 BLACK	AUDI 80, AUDI 100, A2, A4, A6, SCIROCCO, GOLF, PASSAT, POLO, T2, TRANSPORTER, JETTA	32	50
0501 101 338	6N0807199		BLACK BUMPER BAR SCREW	GOLF 4, BORA, CADDY, PASSAT, POLO, SHARAN, TOUAREG, TRANSPORTER	111	25
0501 101 338	N90740701		BLACK BUMPER BAR SCREW	GOLF 4, BORA, CADDY, PASSAT, POLO, SHARAN, TOUAREG, TRANSPORTER	111	25
0501 101 339	8D0805121B		BLACK TURN-LOCK FASTENER 7.0 x 21.0	AUDI 100, A4, A6, PASSAT	119	25
0501 101 340	8D0805121		DELTAPRO QUICK RELEASE SCREW 6 x 18 SLOTTED	AUDI 80, AUDI 100, A2, A4, A6, A8, PASSAT	122	25
0501 101 341	4A0805121B		TURN-LOCK FASTENER 6.0 x 20.0 BLACK	AUDI 80, AUDI 100, A6, A8	117	25
0501 101 343	1H0837111AB41		COVER PLUG PA 6 BLACK	GOLF3, POLO 95, JETTA	6	100
0501 101 344	1H586384901C		COVER PLUG POM BLACK	GOLF 4, BORA, LUPO, PASSAT, POLO, JETTA, A2, A3, A4, A6	7	25
0501 101 345	357867646		COVER PLUG PA 6 BLACK	GOLF3, POLO 95, BORA, LUPO, PASSAT, SHARAN, JETTA	8	100
0501 101 345	3578676469B9		COVER PLUG PA 6 BLACK	GOLF3, POLO 95, BORA, LUPO, PASSAT, SHARAN, JETTA	8	100
0501 101 346	8D0805960		SHEET METAL NUT FOR TURN-LOCK FASTENER SI	PASSAT FROM 1997 TO 2005, A4 FROM 1995 TO 2008, A6 FROM 1995 TO 2010	23	25
0501 101 347	443807269		PLASTIC SPLIT RIVET PP BLACK	AUDI 80, AUDI 100, AUDI 200	47	100
0501 101 348	8L3837199B		PLASTIC SPLIT RIVET BLACK PA 66	A3, A4	48	50
0501 101 349	165827592		EXPANDING NUT PA6.6 BEIGE	A4, A8, NEW BEETLE, BORA, GOLF, PASSAT, POLO, SHARAN, TRANSPORTER, JETTA	58	50
0501 101 350	171807249A		INTERIOR LINING CLIP PA 66 COLORLESS	T2, POLO, SCIROCCO	75	50
0501 101 351	893867290		INTERIOR LINING CLIP PA 66 BROWN	AUDI 80, AUDI 100, A6, A8	81	100
0501 101 352	6K0868243		INTERIOR LINING CLIP BLACK POM	CADDY 96 - 03, POLO CLASSIC 96 - 03	88	25
0501 101 353	1H0868246B		INTERIOR LINING CLIP POM COLORLESS	GOLF, JETTA	89	25
0501 101 354	3B0867333		INTERIOR LINING CLIP POM COLORLESS	A3, BORA, GOLF, LUPO, PASSAT, POLO, SHARAN, TOUAREG	90	50
0501 101 355	3C0867333		INTERIOR LINING CLIP BLACK + GROMMET WHITE PA 66/POM	-	91	50
0501 101 356	357867300		TRIM CLIP POM CLR.	PASSAT 88 - 94	101	50
0501 101 357	8D0853909B		TRIM CLIP CLR. POM	A4 95 - 01	102	50
0501 101 358	6Q0853147		PLUG FOR COARSE STUD BOLT PP/PE BLACK	POLO, TOURAN, GOLF	110	25
0501 101 620	1H0819055B01C	8541ASCHB1B	BLACK FIR-TREE CLIP	GOLF 3, JETTA	4	50
0501 101 621	1H0837719		BLACK INTERIOR LINING CLIP	GOLF, SHARAN, JETTA	5	50
0501 101 622	N90634901		ALUMIN./STEEL BLIND RIVET 4.0 x 14.0	-	10	50
0501 101 623	4A0805163		PLASTIC NUT FOR TURN-LOCK FASTENER	AUDI 80, AUDI 100, A3, A4, A6, A8, PASSAT	22	25
0501 101 624	N90796501		CLAMPING WASHER GEOMET 321 SI	-	28	100
0501 101 627	8L0807300		PLASTIC SPLIT RIVET POM 550 BLACK	A3 1997 - 2003	44	25
0501 101 628	N90229301		PLASTIC SPLIT RIVET PA 12 BLACK*	AUDI 80, AUDI 100, AUDI 200, A6	45	25

Index sorted by Art. No.						
Art. No.	Orig. No.	Eurocode	Designation	Car type	Fig.	P. Qty.
0501 101 629	4D0807300B		BLACK PLASTIC SPLIT RIVET	AUDI A 8 FROM 1994, AUDI A 2 FROM 2000	46	50
0501 101 635	357853585A		INTERIOR LINING CLIP POM WHITE	GOLF, PASSAT	78	25
0501 101 636	6X0867300A		INTERIOR LINING CLIP POM COLORLESS	LUPO 99 - 03	80	50
0501 101 638	6N0868243A		INTERIOR LINING CLIP TWO-PIECE POM BLACK COLORLESS	POLO 95 - 02	84	25
0501 101 639	1H0853585		TRIM CLIP FOR GOLF III (SHORT)	GOLF, JETTA	96	25
0501 101 640	1H0853585B		TRIM CLIP YELLOW	GOLF, JETTA	99	25
0501 101 641	N10209005		FULL STEEL LOCK NUT M10 16 MM	-	105	100
0501 101 642	N0221464		FULL STEEL LOCK NUT M8 13 MM CU COAT. *	-	106	100
0501 101 643	N90085001		FULL STEEL LOCK NUT M8 12 MM CU COAT. *	-	107	100
0501 101 645	N90356203		SHEET-METAL NUT M 5 MET. CORR. PROT. 2.2 SI GLIDE ADDIT. SELF-LOCK.	-	17	100
0501 101 646	N90168604		SHEET-METAL NUT M 6 MET. CORR. PROT. 2.2 SW GLIDE ADDIT.	GOLF III	18	100
0501 101 647	N0154373		SHEET-METAL NUT ST 4.8 MM GALV. MET. CORR. PROT. SI	A2	25	100
0501 101 648	N0154391		SHEET-METAL NUT ST 4.8 MM 2.5 - 2.8 MM MET. CORR. PROT. 1	LEON FROM 2004	26	100
0501 101 649	N90335004		QUICKY FOR T-BOLT 5 X 30 MM GEO PLUS	A4, AUDI TT, BORA, GOLF, JETTA, LT, NEW BEETLE, PASSAT, POLO, TRANSPORTER	27	100
0501 101 649	N90335006		QUICKY FOR T-BOLT 5 X 30 MM GEO PLUS	A4, AUDI TT, BORA, GOLF, JETTA, LT, NEW BEETLE, PASSAT, POLO, TRANSPORTER	27	100
0501 101 650	811971850		CABLE TIE WITH LOCKING BASE FOR T-BOLT BLACK	AUDI 80, AUDI 100, AUDI 200, A6, GOLF, POLO, JETTA	30	100
0501 101 651	4A0823570		LINKAGE HOLDER COLORLESS	AUDI 100, A6	31	100
0501 101 652	N0385011		PLASTIC SPLIT RIVET PA6 N	-	35	100
0501 101 653	N10446801		ROTATING PIPE AND CABLE HOLDER PA 66 BLACK	-	50	100
0501 101 654	N10275101		ROTATING PIPE AND CABLE HOLDER POM BLACK	-	51	50
0501 101 655	1J0858137A		PLUG-IN CLIP PHOSD.	BORA, GOLF, POLO, SHARAN	64	100
0501 101 656	3B0867190		PLUG-IN CLIP PHOSD. PAINT YE	BORA, GOLF, PASSAT, POLO	65	100
0501 101 657	211853615		GROMMET PE 181 COLORLESS	AUDI 80, AUDI 100, A3, NEW BEETLE, CADDY, SCIROCCO, GOLF, PASSAT, POLO, T2, T3, SHARAN, TRANSPORTER, JETTA	71	100
0501 101 658	N90323501		DOUBLE U-CLIP MET. CORR. PROT. 2.2 BK	-	72	100
0501 101 659	7M0867299K		YELLOW INTERIOR LINING CLIP	A3, A6, POLO, SHARAN, TRANSPORTER, TOLEDO, ALHAMBRA	73	100
0501 101 660	443867299		INTERIOR LINING CLIP POM COLORLESS	AUDI 100, AUDI 200, TRANSPORTER	79	100
0501 101 661	4D0867299D		INTERIOR LINING CLIP POM BLACK	A8 94 - 03	82	100
0501 101 662	6Q0868243		BLACK INTERIOR LINING CLIP	VW: CADDY, GOLF4, GOLF PLUS, POLO 2002, TOURAN, PHAETON	85	100
0501 101 663	8E0868243		INTERIOR LINING CLIP POM BLACK	A4 01 - 03	86	100
0501 101 664	5X0867299		INTERIOR LINING CLIP POM + SEAL BLACK*	FOX, POLO	87	100
0501 101 665	4F0805121		BLACK PLASTIC TURN-LOCK FASTENER	-	121	25

Index sorted by Art. No.						
Art. No.	Orig. No.	Eurocode	Designation	Car type	Fig.	P. Qty.
0501 101 666	N90698701		SHEET-METAL NUT ST 4.2 MM PHOSD. IMP.	-	16	100
0501 101 666	N90698703		SHEET-METAL NUT ST 4.2 MM PHOSD. IMP.	-	16	100
0501 102 006	4D0868637		EXPANDING NUT PA 6 GF 1.5 BLACK	A8 99 - 03	53	100
0501 103 035	N10219501		PLASTIC SPLIT RIVET PA 661 BLACK	LT	38	25
0501 103 035	N10219502		PLASTIC SPLIT RIVET PA 661 BLACK	LT	38	25
0501 103 044	171853615A		BLACK GROMMET	-	69	100
0501 104 038	N10032301		PLASTIC SPLIT RIVET BK UNDERRIDE GUARD FASTENER PA122	SEAT ALHAMBRA	41	50
0501 104 105	191867199		FIR-TREE CLIP PE BLACK	BORA, GOLF, LUPO, PASSAT, POLO, TRANSPORTER, JETTA, CADDY	1	50
0501 104 105	19186719901C		FIR-TREE CLIP PE BLACK	BORA, GOLF, LUPO, PASSAT, POLO, TRANSPORTER, JETTA, CADDY	1	50
0501 104 122	171885767		PLASTIC SPLIT RIVET PA 66 BLACK	SCIROCCO, GOLF, LT	42	100
0501 105 064	N90359101		PLASTIC SPLIT RIVET FOR BUMPER PA 66 BLACK	GOLF	49	50
0501 121 123	441035555		EXPANDING NUT PA 661 COLORLESS	A8, GOLF, LUPO, TOUAREG, JETTA	52	100
0501 121 130	8E9867299	2730ASCTS1B	INTERIOR LINKING CLIP PA CLR.	-	92	50
0501 301 001	1H0819055C01C	8541ASCHB	THREADED BLIND RIVET FOR SQUARE WITH CAP PA 6 BLACK	GOLF, JETTA	114	25
0501 301 002	6K0819285B41	7609ASSHB	THREADED BLIND RIVET PA 6 BLACK	POLO VARIANT, CADDY, IBIZA 93 - 02	115	25
0501 301 003	1M0854541A	7608ASCSS	TRIM CLIP YELLOW WITH RUBBER SEAL BK	TOLEDO, LEON FROM 05	103	25
0501 301 004	1M0854719A	7608ASCSS1B	TRIM CLIP SEAT BLACK*	TOLEDO, LEON FROM 05	104	25

Index sorted by Orig. No.						
Orig. No.	Art. No.	Eurocode	Designation	Car type	Fig.	P. Qty.
	0500 115 22		SHEET-METAL NUT ST 4.8 MM GALV. CLR. PASSIV.	GOLF 3	12	100
113853585C	0500 123 301		TRIM CLIP WITH RED RING	AUDI 80, SCIROCCO, GOLF, PASSAT, T3, JETTA	94	50
113853615	0500 117 07		GROMMET FOR LETTERING PE 181 CLR.	AUDI 80, AUDI 100, T3, SCIROCCO, GOLF, PASSAT, POLO	66	100
113853615A	0500 122 33		GROMMET PE LD COLORLESS	-	67	100
113857117B	0500 143 00		BLACK PLASTIC SPLIT RIVET POM	T1, GOLF, PASSAT, AUDI 100	33	50
113857219A	0500 117 75		BLACK GROMMET	SCIROCCO, GOLF, PASSAT, POLO, JETTA	68	100
16186729901C	0501 101 000		PLASTIC SPLIT RIVET PA66 BK	AUDI 80, AUDI 200, A4, NEW BEETLE, BORA, SCIROCCO, GOLF, PASSAT, POLO, JETTA, TRANSPORTER	40	100
N038549101C	0501 101 000		PLASTIC SPLIT RIVET PA66 BK	AUDI 80, AUDI 200, A4, NEW BEETLE, BORA, SCIROCCO, GOLF, PASSAT, POLO, JETTA, TRANSPORTER	40	100
165827592	0501 101 349		EXPANDING NUT PA6.6 BEIGE	A4, A8, NEW BEETLE, BORA, GOLF, PASSAT, POLO, SHARAN, TRANSPORTER, JETTA	58	50
171201969	0501 101 322		PLASTIC NUT PA 6 GF 30 BLACK	AUDI 80, AUDI 100, A2, A4, A6, SCIROCCO, GOLF, PASSAT, POLO, T2, TRANSPORTER, JETTA	32	50
171807249A	0501 101 350		INTERIOR LINING CLIP PA 66 COLORLESS	T2, POLO, SCIROCCO	75	50
171853615A	0501 103 044		BLACK GROMMET	-	69	100
171867299B	0501 101 308		CLEAR INTERIOR LINING CLIP	-	76	50
171885767	0501 104 122		PLASTIC SPLIT RIVET PA 66 BLACK	SCIROCCO, GOLF, LT	42	100
191853733A	0501 101 003	7603ASCH	CLEAR ROOF TRIM CLIP	CADDY, GOLF, PASSAT, POLO, JETTA	95	50
6U0853733	0501 101 003	7603ASCH	CLEAR ROOF TRIM CLIP	CADDY, GOLF, PASSAT, POLO, JETTA	95	50
191867199	0501 104 105		FIR-TREE CLIP PE BLACK	BORA, GOLF, LUPO, PASSAT, POLO, TRANSPORTER, JETTA, CADDY	1	50
19186719901C	0501 104 105		FIR-TREE CLIP PE BLACK	BORA, GOLF, LUPO, PASSAT, POLO, TRANSPORTER, JETTA, CADDY	1	50
1H0819055B01C	0501 101 620	8541ASCHB1B	BLACK FIR-TREE CLIP	GOLF 3, JETTA	4	50
1H0819055C01C	0501 301 001	8541ASCHB	THREADED BLIND RIVET FOR SQUARE WITH CAP PA 6 BLACK	GOLF, JETTA	114	25
1H0823717	0501 101 204		DOOR SEAL CLIP PA 66 BLACK	BORA, GOLF, LUPO, PASSAT, SHARAN, JETTA	109	100
1H0837111AB41	0501 101 343		COVER PLUG PA 6 BLACK	GOLF3, POLO 95, JETTA	6	100
1H0837719	0501 101 621		INTERIOR LINING CLIP BLACK	GOLF, SHARAN, JETTA	5	50
1H0853585	0501 101 639		TRIM CLIP FOR GOLF III (SHORT)	GOLF, JETTA	96	25
1H0853585B	0501 101 640		TRIM CLIP YELLOW	GOLF, JETTA	99	25
1H0853586	0501 101 318		GREEN GROMMET FOR TRIM CLIP VW	A3, BORA, SCIROCCO, GOLF, PASSAT, POLO, JETTA, TOUAREG	70	50
1H0853733B	0501 101 208	8541ASCH	TRIM CLIP POM COLORLESS	GOLF, JETTA	100	50

Index sorted by Orig. No.						
Orig. No.	Art. No.	Eurocode	Designation	Car type	Fig.	P. Qty.
1H0868243B	0501 101 311		CLEAR/BROWN INTERIOR LINING CLIP	GOLF III, GOLF IV, JETTA	83	25
1H0868243	0501 101 311		CLEAR/BROWN INTERIOR LINING CLIP	GOLF III, GOLF IV, JETTA	83	25
1H0868246B	0501 101 353		INTERIOR LINING CLIP POM COLORLESS	GOLF, JETTA	89	25
1H586384901C	0501 101 344		COVER PLUG POM BLACK	GOLF 4, BORA, LUPO, PASSAT, POLO, JETTA, A2, A3, A4, A6	7	25
1J0858137A	0501 101 655		PLUG-IN CLIP PHOSD.	BORA, GOLF, POLO, SHARAN	64	100
1M0854541A	0501 301 003	7608ASCSS	TRIM CLIP YELLOW WITH RUBBER SEAL BK	TOLEDO, LEON FROM 05	103	25
1M0854719A	0501 301 004	7608ASCSS1B	TRIM CLIP SEAT BLACK*	TOLEDO, LEON FROM 05	104	25
211853615	0501 101 657		GROMMET PE 181 COLORLESS	AUDI 80, AUDI 100, A3, NEW BEETLE, CADDY, SCIROCCO, GOLF, PASSAT, POLO, T2, T3, SHARAN, TRANSPORTER, JETTA	71	100
251823717	0500 147 20		DOOR SEAL CLIP PA 665 BLACK	SCIROCCO, GOLF, LUPO, POLO, SHARAN, T2, TRANSPORTER, JETTA	108	100
311821161	0500 114 03		SHEET-METAL NUT ST 6.3 MM HALF GALV. CLR. PASSIV. MATT	UNIVERSAL	14	100
321813998A	0500 142 24		EXPANDING NUT PA 66 COLORLESS*	AUDI 80, AUDI 100, AUDI 200, GOLF, PASSAT, JETTA	57	50
321853139A	0500 148 02		PLASTIC SPLIT RIVET PA66 BLACK	GOLF, PASSAT, JETTA	37	25
357827998	0501 101 229		EXPANDING NUT PA 6 BLACK	POLO 00 - 02, GOLF II, PASSAT, VENTO	59	50
357853585A	0501 101 635		INTERIOR LINING CLIP POM WHITE	GOLF, PASSAT	78	25
357867300	0501 101 356		TRIM CLIP POM CLR.	PASSAT 88 - 94	101	50
357867646	0501 101 345		COVER PLUG PA 6 BLACK	GOLF3, POLO 95, BORA, LUPO, PASSAT, SHARAN, JETTA	8	100
3578676469B9	0501 101 345		COVER PLUG PA 6 BLACK	GOLF3, POLO 95, BORA, LUPO, PASSAT, SHARAN, JETTA	8	100
357868143	0501 101 230		EXPANDING NUT PA 6 GRAY	NEW BEETLE, GOLF, PASSAT, POLO, JETTA, TRANSPORTER	60	50
3A0601139	0362 312 15		WHEEL BOLT GALV. CLR. M12X1.5X22.5 17 MM *	AUDI 80, A2, CADDY, SCIROCCO, GOLF, LUPO, PASSAT, POLO, JETTA	112	50
3B0867190	0501 101 656		PLUG-IN CLIP PHOSD. PAINT YE	BORA, GOLF, PASSAT, POLO	65	100
3B0867333	0501 101 354		INTERIOR LINING CLIP POM COLORLESS	A3, BORA, GOLF, LUPO, PASSAT, POLO, SHARAN, TOUAREG	90	50
3B0868243	0501 101 219		INTERIOR LINING CLIP VW POM BLACK	BORA, GOLF, PASSAT, TOLEDO, LEON, IBIZA	77	25
3C0867333	0501 101 355		INTERIOR LINING CLIP BLACK + GROMMET WHITE PA 66/POM	-	91	50
441035555	0501 121 123		EXPANDING NUT PA 661 COLORLESS	A8, GOLF, LUPO, TOUAREG, JETTA	52	100
443807269	0501 101 347		PLASTIC SPLIT RIVET PP BLACK	AUDI 80, AUDI 100, AUDI 200	47	100
443867299	0501 101 660		INTERIOR LINING CLIP POM COLORLESS	AUDI100, AUDI 200, TRANSPORTER	79	100
481853577A	0500 128 21		PLASTIC SPLIT RIVET PA66 NATURAL	A4, A6, PASSAT, POLO	43	25
4A0805121A	0501 101 301		BLACK PLASTIC TURN-LOCK FASTENER	AUDI 80, AUDI 100, A3, A4, A6, A8, PASSAT	116	25
4A0805121B	0501 101 341		TURN-LOCK FASTENER 6.0 x 20.0 BLACK	AUDI 80, AUDI 100, A6, A8	117	25

Index sorted by Orig. No.						
Orig. No.	Art. No.	Eurocode	Designation	Car type	Fig.	P. Qty.
4A0805121C	0501 101 300		BLACK PLASTIC TURN-LOCK FASTENER	A4, A8	118	25
4A0805163	0501 101 623		PLASTIC NUT FOR TURN-LOCK FASTENER	AUDI 80, AUDI 100, A3, A4, A6, A8, PASSAT	22	25
4A0823570	0501 101 651		LINKAGE HOLDER COLORLESS	AUDI 100, A6	31	100
4D0807300B	0501 101 629		BLACK PLASTIC SPLIT RIVET	AUDI A 8 FROM 1994, AUDI A 2 FROM 2000	46	50
4D0867299D	0501 101 661		INTERIOR LINING CLIP POM BLACK	A8 94 - 03	82	100
4D0868637	0501 102 006		EXPANDING NUT PA 6 GF 15 BLACK	A8 99 - 03	53	100
4F0805121	0501 101 665		BLACK PLASTIC TURN-LOCK FASTENER	-	121	25
5X0867299	0501 101 664		INTERIOR LINING CLIP POM + SEAL BLACK*	FOX, POLO	87	100
6K0819285B41	0501 301 002	7609ASSHB	THREADED BLIND RIVET PA 6 BLACK	POLO VARIANT, CADDY, IBIZA 93 - 02	115	25
6K0868243	0501 101 352		INTERIOR LINING CLIP BLACK POM	CADDY 96 - 03, POLO CLASSIC 96 - 03	88	25
6N0807199	0501 101 338		BLACK BUMPER BAR SCREW	GOLF 4, BORA, CADDY, PASSAT, POLO, SHARAN, TOUAREG, TRANSPORTER	111	25
N90740701	0501 101 338		BLACK BUMPER BAR SCREW	GOLF 4, BORA, CADDY, PASSAT, POLO, SHARAN, TOUAREG, TRANSPORTER	111	25
6N0868243A	0501 101 638		INTERIOR LINING CLIP TWO-PIECE POM BLACK COLORLESS	POLO 95 - 02	84	25
6Q0853147	0501 101 358		PLUG FOR COARSE STUD BOLT PP/PE BLACK	POLO, TOURAN, GOLF	110	25
6Q0868243	0501 101 662		BLACK INTERIOR LINING CLIP	VW: CADDY, GOLF4, GOLF PLUS, POLO 2002, TOURAN, PHAETON	85	100
6X0867300A	0501 101 636		INTERIOR LINING CLIP POM COLORLESS	LUPO 99 - 03	80	50
7M0867299K	0501 101 659		YELLOW INTERIOR LINING CLIP	A3, A6, POLO, SHARAN, TRANSPORTER, TOLEDO, ALHAMBRA	73	100
80186729901C	0500 917 0		COVER PLUG POM BLACK	GOLF, POLO, BORA, PASSAT, JETTA	3	50
801867299041	0500 917 0		COVER PLUG POM BLACK	GOLF, POLO, BORA, PASSAT, JETTA	3	50
803821117	0500 113 69		SHEET-METAL NUT ST 6.3 MM GALV. CLR. PASSIV. MATT	AUDI 80, PASSAT, POLO, T3	13	100
811807577C	0501 101 001		EXPANDING NUT PA GF 30 BK	AUDI 80, AUDI 100, AUDI 200, A2, A3, A4, A6, A8, NEW BEETLE, BORA, SCIROCCO, GOLF, POLO, TRANSPORTER, JETTA	56	50
811807577F	0500 879 33		EXPANDING NUT PA6 GF 30 BK	-	55	50
811971850	0501 101 650		CABLE TIE WITH LOCKING BASE FOR T-BOLT BLACK	AUDI 80, AUDI 100, AUDI 200, A6, GOLF, POLO, JETTA	30	100
82386320301C	0500 921 9		BLACK FIR-TREE CLIP	GOLF 88, PASSAT, POLO, AUDI 80, AUDI 100, A4, A6, A8	2	25
823867299	0500 129 54		INTERIOR LINING CLIP PA 66 BLACK	AUDI 80, AUDI 100, AUDI 200, A6, A8, CADDY, SCIROCCO, GOLF, PASSAT, POLO, T2, JETTA, TRANSPORTER	74	50
867809966	0500 879 32		EXPANDING NUT PA6 GF 30 BK	GOLF	54	50
893867290	0501 101 351		INTERIOR LINING CLIP PA 66 BROWN	AUDI 80, AUDI 100, A6, A8	81	100

Index sorted by Orig. No.						
Orig. No.	Art. No.	Eurocode	Designation	Car type	Fig.	P. Qty.
8D0601139D	0362 014 15		WHEEL BOLT GEOMET BLACK M14X1.5X25.5 17 MM *	A80, A100, A200, A2, A3, A4, A6,A8, AUDI TT, NEW BEETLE, BORA, GOLF, PAS- SAT, POLO, JETTA	113	50
8D0805121	0501 101 340		DELTAPRO QUICK RELEASE SCREW 6 x 18 SLOTTED	AUDI 80, AUDI 100, A2, A4, A6, A8, PASSAT	122	25
8D0805121B	0501 101 339		BLACK TURN-LOCK FASTENER 7.0 x 21.0	AUDI 100, A4, A6, PASSAT	119	25
8D0805960	0501 101 346		SHEET METAL NUT FOR TURN-LOCK FASTENER SI	PASSAT FROM 1997 TO 2005, A4 FROM 1995 TO 2008, A6 FROM 1995 TO 2010	23	25
8D0853909B	0501 101 357		TRIM CLIP CLR. POM	A4 95 - 01	102	50
8E0805121A	0501 101 321		TURN-LOCK FASTENER WITH SEAL 7.0 x 12.0	A4 01 - 03, A6	120	25
8E0868243	0501 101 663		INTERIOR LINING CLIP POM BLACK	A4 01 - 03	86	100
8E9867299	0501 121 130	2730ASCTS1B	INTERIOR LINKING CLIP PA CLR.	-	92	50
8L0807300	0501 101 627		PLASTIC SPLIT RIVET POM 550 BLACK	A3 1997 - 2003	44	25
8L3837199B	0501 101 348		PLASTIC SPLIT RIVET BLACK PA 66	A3, A4	48	50
N0143893	0500 116 39		PAPERBOARD CLIP GALV. CLR.	-	93	25
N143893	0500 116 39		PAPERBOARD CLIP GALV. CLR.	-	93	25
N0154292	0500 113 62		SHEET-METAL NUT ST 4.2 MM GALV. CLR. PASSIV.	-	11	100
N0154373	0501 101 647		SHEET-METAL NUT ST 4.8 MM GALV. MET. CORR. PROT. SI	A2	25	100
N0154391	0501 101 648		SHEET-METAL NUT ST 4.8 MM 2.5 - 2.8 MM MET. CORR. PROT. 1	LEON FROM 2004	26	100
N0221464	0501 101 642		FULL STEEL LOCK NUT M8 13 MM CU COAT. *	-	106	100
N0385011	0501 101 652		PLASTIC SPLIT RIVET PA6 N	-	35	100
N0385012	0500 127 10		PLASTIC SPLIT RIVET PA6 BK	-	36	50
N0385501	0500 937 7		PLASTIC SPLIT RIVET PA 66 DARK GRAY	AUDI TT, BORA, CADDY, CORRADO, GOLF 1+2+3, JETTA, LT, NEW BEETLE, PASSAT, PHAETON, POLO, SHARAN, TOUAREG, TRANS- PORTER, VENTO	39	100
N10032301	0501 104 038		PLASTIC SPLIT RIVET BK UNDERRIDE GUARD FASTENER PA122	SEAT ALHAMBRA	41	50
N10209005	0501 101 641		FULL STEEL LOCK NUT M10 16 MM	-	105	100
N10219501	0501 103 035		PLASTIC SPLIT RIVET PA 661 BLACK	LT	38	25
N10219502	0501 103 035		PLASTIC SPLIT RIVET PA 661 BLACK	LT	38	25
N10259301	0500 523 14		PLASTIC SPLIT RIVET PA12 BLACK	A6, S6, SEAT LEON 2004	34	50
110853934	0500 523 14		PLASTIC SPLIT RIVET PA12 BLACK	A6, S6, SEAT LEON 2004	34	50
N10275101	0501 101 654		ROTATING PIPE AND CABLE HOLDER POM BLACK	-	51	50
N10446801	0501 101 653		ROTATING PIPE AND CABLE HOLDER PA 66 BLACK	-	50	100
N90048801	0500 136 58		SHEET-METAL NUT ST 3.5 MM GALV. CLR. PASSIV.	-	15	100
N90049701	0500 135 76		SHEET-METAL NUT ST 4.8 MM GALV. CLR. PASSIV.	-	24	100
N90057901	0500 136 29		SHEET-METAL NUT ST 4.2 MM PHOSD. IMP.	-	19	100
N90074301	0500 137 04		SHEET-METAL NUT ST 3.9 MM GALV.	-	20	100
N90085001	0501 101 643		FULL STEEL LOCK NUT M8 12 MM CU COAT. *	-	107	100
N90094201	0500 139 56		SHEET-METAL NUT ST 4.8 MM GALV. CLR. PASSIV.	-	21	100
N90168604	0501 101 646		SHEET-METAL NUT M 6 MET. CORR. PROT. 2.2 SW GLIDE ADDIT.	GOLF III	18	100
N90205501	0500 238 3		CABLE TIE WITH BASE PA66 BLACK	AUDI 100, COUPÉ	29	25

Index sorted by Orig. No.						
Orig. No.	Art. No.	Eurocode	Designation	Car type	Fig.	P. Qty.
N90229301	0501 101 628		PLASTIC SPLIT RIVET PA 12 BLACK*	AUDI 80, AUDI 100, AUDI 200, A6	45	25
N90323501	0501 101 658		DOUBLE U-CLIP MET. CORR. PROT. 2.2 BK	-	72	100
N90335004	0501 101 649		QUICKY FOR T-BOLT 5 X 30 MM GEO PLUS	A4, AUDI TT, BORA, GOLF, JETTA, LT, NEW BEETLE, PASSAT, POLO, TRANSPORTER	27	100
N90335006	0501 101 649		QUICKY FOR T-BOLT 5 X 30 MM GEO PLUS	A4, AUDI TT, BORA, GOLF, JETTA, LT, NEW BEETLE, PASSAT, POLO, TRANSPORTER	27	100
N90356203	0501 101 645		SHEET-METAL NUT M 5 MET. CORR. PROT. 2.2 SI GLIDE ADDIT. SELF-LOCK.	-	17	100
N90359101	0501 105 064		PLASTIC SPLIT RIVET FOR BUMPER PA 66 BLACK	GOLF	49	50
N90535301	0501 101 232		GREY EXPANDING NUT	POLO 1995	61	50
N90634901	0501 101 622		ALUMIN./STEEL BLIND RIVET 4.0 x 14.0	-	10	50
N90698701	0501 101 666		SHEET-METAL NUT ST 4.2 MM PHOSD. IMP.	-	16	100
N90698703	0501 101 666		SHEET-METAL NUT ST 4.2 MM PHOSD. IMP.	-	16	100
N90796501	0501 101 624		GEOMET CLAMPING WASHER 321 SI	-	28	100
N90821401	0501 101 233		EXPANDING NUT PA 6 BLACK	A2, A3, A4, A6, A8, TT, BORA, GOLF, LUPO, NEW BEETLE, PASSAT, POLO, TOUAREG	62	50
N90833801	0501 101 319		EXPANDING NUT PA 66 BLACK*	A3, A4, BORA, CADDY, GOLF, JETTA, LUPO, NEW BEETLE, PASSAT, PHAETON, POLO, TOURAN	63	50



Art. No. 0501 105 601
 Orig. No.: 51471904317
 Fig. No.: 1

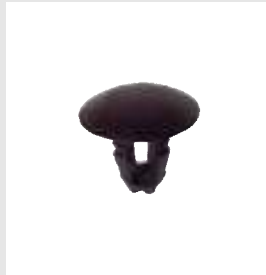

Art. No. 0501 105 082
 Orig. No.: 51488181420
 Fig. No.: 2



Art. No. 0501 105 121
 Orig. No.: 52201964201
 Fig. No.: 3

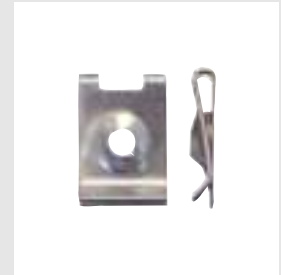

Art. No. 0500 113 62
 Orig. No.: 07129925709
 07129901644
 Fig. No.: 4



Art. No. 0500 115 22
 Orig. No.: 07129925712
 Fig. No.: 5

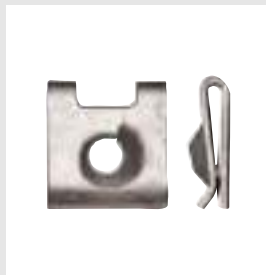

Art. No. 0500 113 65
 Orig. No.: 07129925713
 07129901649
 Fig. No.: 6

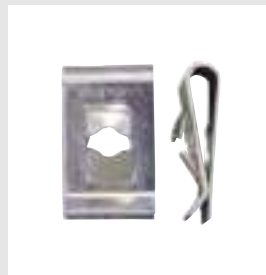

Art. No. 0500 053 7
 Orig. No.: 07129925738
 07129901654
 Fig. No.: 7



Art. No. 0500 115 77
 Orig. No.: 07129925720
 Fig. No.: 8



Art. No. 0500 113 69
 Orig. No.:
 Fig. No.: 9



Art. No. 0500 114 04
 Orig. No.: 07129925743
 Fig. No.: 10



Art. No. 0500 114 70
 Orig. No.: 07129925737
 07129901651
 Fig. No.: 11

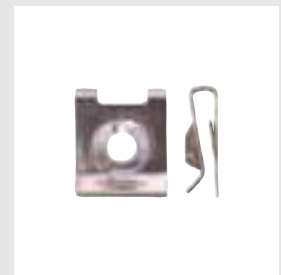

Art. No. 0500 116 67
 Orig. No.: 07129925730
 07129901645
 Fig. No.: 12



Art. No. 0500 114 27
 Orig. No.: 07129925742
 07129901663
 Fig. No.: 13



Art. No. 0501 105 083
 Orig. No.: 52532308647
 Fig. No.: 14



Art. No. 0501 105 073
 Orig. No.: 07129901656
 07129925734
 Fig. No.: 15



Art. No. 0500 117 61
 Orig. No.: 07129925749
 Fig. No.: 16



Art. No. 0500 533 12
 Orig. No.: 51127070202
 Fig. No.: 17

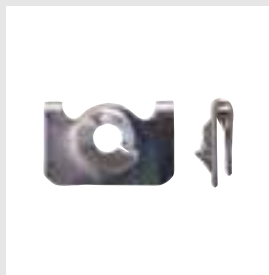

Art. No. 0501 105 108
 Orig. No.: 07129925707
 Fig. No.: 18

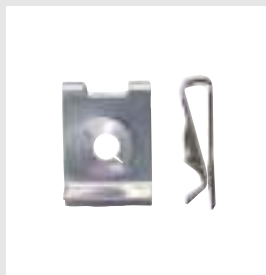

Art. No. 0501 105 109
 Orig. No.: 07129925727
 Fig. No.: 19



Art. No. 0501 105 122
 Orig. No.: 11127534165
 Fig. No.: 20

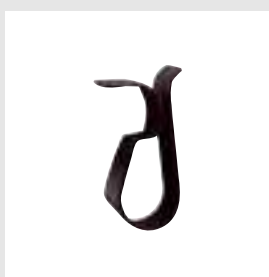

Art. No. 0501 105 111
 Orig. No.: 51131872146
 Fig. No.: 21



Art. No. 0501 105 113
 Orig. No.: 07129926302
 Fig. No.: 22

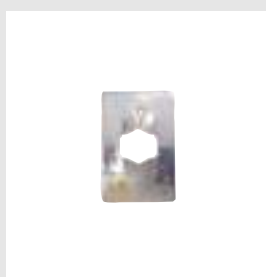

Art. No. 0500 111 82
 Orig. No.: 07129926306
 Fig. No.: 23

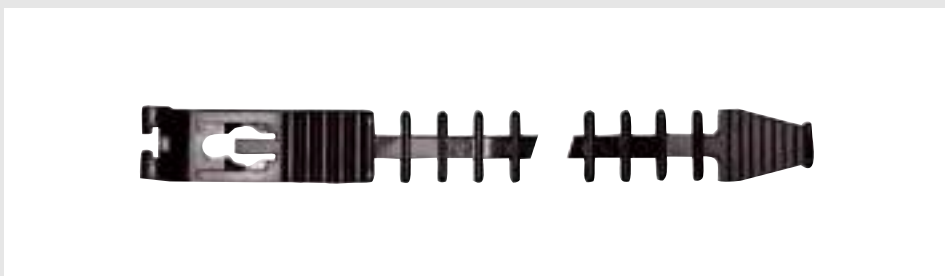

Art. No. 0500 909 93
 Orig. No.: 12321276231
 Fig. No.: 24

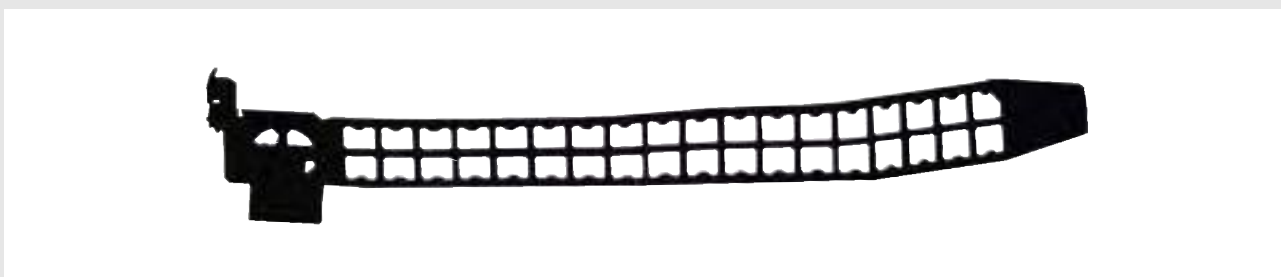

Art. No. 0501 105 004
 Orig. No.: 61131386642
 Fig. No.: 25



Art. No. 0501 104 051
 Orig. No.: 16131176747
 Fig. No.: 26



Art. No. 0501 104 050
 Orig. No.: 51711958025
 Fig. No.: 27



Art. No. 0500 126 96
 Orig. No.:
 Fig. No.: 28



Art. No. 0500 523 14
 Orig. No.: 51161881149
 Fig. No.: 29



Art. No. 0501 101 000
 Orig. No.: 51471916670
 Fig. No.: 30



Art. No. 0501 105 084
 Orig. No.: 51718195811
 Eurocode: 2431AKCSB1F
 2431ASC6B6B
 Fig. No.: 31



Art. No. 0501 105 041
 Orig. No.: 51711928946
 Eurocode: 2426AKCS2G
 2426ASSS
 Fig. No.: 32

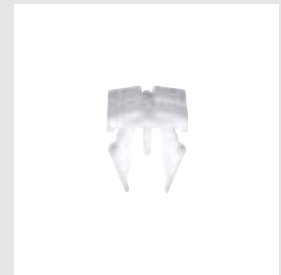

Art. No. 0501 105 017
 Orig. No.: 51718108613
 Eurocode: 2433ASC6B
 Fig. No.: 33



Art. No. 0501 105 035
 Orig. No.: 51481884779
 Fig. No.: 34



Art. No. 0501 105 063
 Orig. No.: 51111944537
 Fig. No.: 35



Art. No. 0501 105 064
 Orig. No.: 51111908077
 Fig. No.: 36

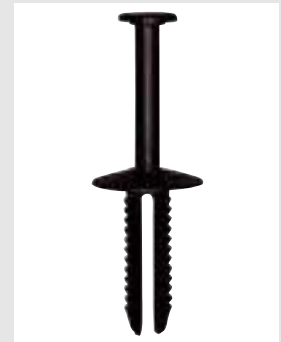

Art. No. 0501 105 065
 Orig. No.: 51111964186
 Fig. No.: 37



Art. No. 0501 105 078
 Orig. No.: 51118174185
 Fig. No.: 38



Art. No. 0500 201 404
 Orig. No.: 51471911992
 Fig. No.: 39



Art. No. 0501 105 016
 Orig. No.: 51481938725
 Fig. No.: 40



Art. No. 0501 105 117
 Orig. No.: 51498166702
 Fig. No.: 41



Art. No. 0501 105 045
 Orig. No.: 51441854624
 Fig. No.: 42

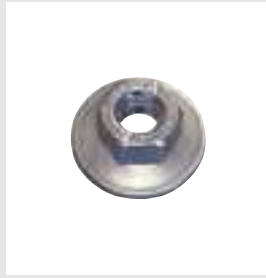

Art. No. 0501 103 057
 Orig. No.: 51111835624
 Fig. No.: 43



Art. No. 0501 104 117
 Orig. No.: 63171367868
 Fig. No.: 44



Art. No. 0500 910 1
 Orig. No.: 51135680113
 Fig. No.: 45



Art. No. 0500 185 2
 Orig. No.: 51181852299
 Fig. No.: 46



Art. No. 0500 117 07
 Orig. No.:
 Fig. No.: 47



Art. No. 0501 105 068
 Orig. No.: 51141807495
 Fig. No.: 48



Art. No. 0501 105 119
 Orig. No.: 51131870459
 Fig. No.: 49



Art. No. 0501 105 120
 Orig. No.: 51711932996
 Fig. No.: 50

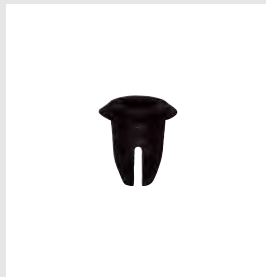

Art. No. 0501 305 001
 Orig. No.: 51318150943
 Eurocode: 2433ASC6B6
 Fig. No.: 51



Art. No. 0500 136 76
 Orig. No.: 51411870718
 Fig. No.: 52

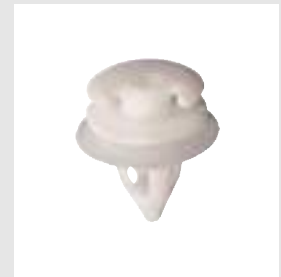

Art. No. 0501 105 400
 Orig. No.: 51411973500
 Fig. No.: 53



Art. No. 0501 105 123
 Orig. No.: 51418172050
 Fig. No.: 54



Art. No. 0501 105 085
 Orig. No.: 07147145753
 Eurocode: 2440ASCHS
 2455ASCHS
 Fig. No.: 55



Art. No. 0500 116 39
 Orig. No.: 51416654189
 Fig. No.: 56

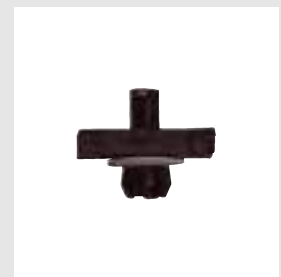

Art. No. 0500 914 2
 Orig. No.: 51131804205
 Fig. No.: 57



Art. No. 0500 127 98
 Orig. No.: 51131816019
 Fig. No.: 58



Art. No. 0500 131 43
 Orig. No.: 51471840961
 Fig. No.: 59



Art. No. 0500 133 68
 Orig. No.: 51131848664
 Fig. No.: 60



Art. No. 0500 929 6
 Orig. No.: 51131848312
 Fig. No.: 61



Art. No. 0501 105 006
 Orig. No.: 51131960054
 Fig. No.: 62



Art. No. 0501 105 401
 Orig. No.: 51131946258
 Fig. No.: 63



Art. No. 0501 105 089
 Orig. No.: 51777166869
 Fig. No.: 64



Art. No. 0501 105 020
 Orig. No.: 51712234032
 Fig. No.: 65



Art. No. 0501 305 004
 Orig. No.: 52311938494
 Eurocode: 2426ASCS1
 Fig. No.: 66

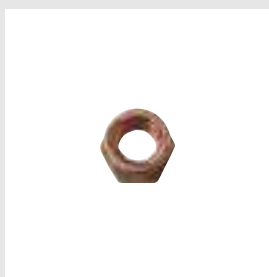

Art. No. 0366 1
 Orig. No.: 11621304755
 Fig. No.: 67

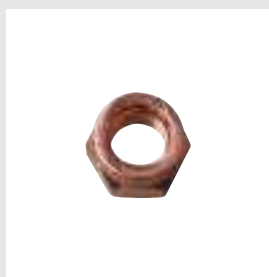

Art. No. 0366 2
 Orig. No.: 11621744323
 Fig. No.: 68

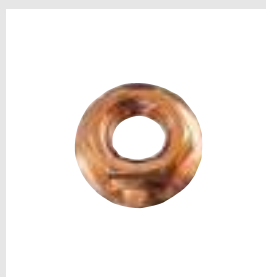

Art. No. 0365 8
 Orig. No.: 11621711954
 Fig. No.: 69



Art. No. 0501 105 126
 Orig. No.: 11127531561
 Fig. No.: 70

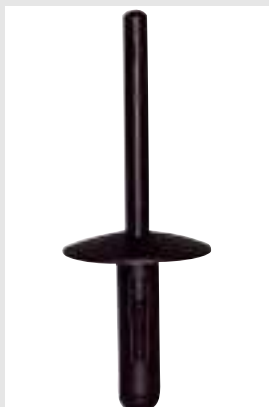

Art. No. 0501 105 124
 Orig. No.: 51717002953
 Fig. No.: 71



Art. No. 0500 411
 Orig. No.: 51711952019
 Fig. No.: 72



Art. No. 0501 104 039
 Orig. No.:
 Fig. No.: 73



Art. No. 0501 105 125
 Orig. No.: 51218205295
 Eurocode: 2434ASCSCB
 Fig. No.: 74



Art. No. 0501 105 086
 Orig. No.: 51481915964
 Fig. No.: 75



Art. No. 0501 105 015
 Orig. No.: 51321938884
 Eurocode: 2431LSCSFD
 Fig. No.: 76



Art. No. 0501 305 006
 Orig. No.: 51137145109
 Eurocode: 2447ASCSS1B
 Fig. No.: 77



Art. No. 0500 965
 Orig. No.: 51311938494
 51318177850
 Eurocode: 2426AKCS1G
 2426ASCS
 Fig. No.: 78



Art. No. 0501 305 007
 Orig. No.: 51137145110
 Eurocode: 2447ASCSS
 Fig. No.: 79



Art. No. 0501 305 008
 Orig. No.: 51137172103
 Eurocode: 2447ASCSS2B
 Fig. No.: 80



Art. No. 0501 305 005
 Orig. No.: 51313401691
 51313448374
 Eurocode: 2449ASCRS
 Fig. No.: 81



Art. No. 0501 305 002
 Orig. No.: 51317064098
 Eurocode: 2445ASCSS
 Fig. No.: 82

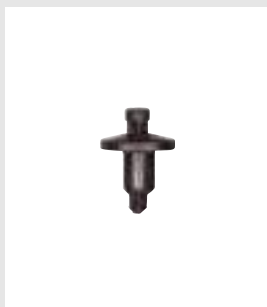

Art. No. 0501 305 003
 Orig. No.: 51138174852
 Eurocode: 2433ASSS
 Fig. No.: 83

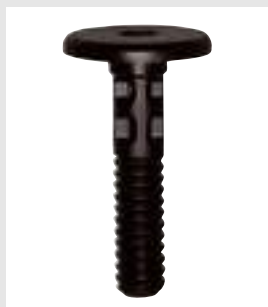

Art. No. 0501 105 088
 Orig. No.: 07147122913
 Fig. No.: 84



Art. No. 0501 105 087
 Orig. No.: 07147122912
 Fig. No.: 85

Index sorted by Art. No.						
Art. No.	Orig. No.	Eurocode	Designation	Car type	Fig.	P. Qty.
0365 8	11621711954		SELF-LOCKING FLANGED NUT M 8 12 MM CU COAT.*	E81, E82, E87, E88, E36, E46, E90, E91, E92, E93, E34, E39, E60, E61, E32, E38, Z3, Z4	69	100
0366 1	11621304755		SLOTTED NUT 14441 M 6 x 1 9 MM CU COAT. 6MY *	E24, E28, E30, E34	67	100
0366 2	11621744323		SLOTTED NUT 14441 M 8 x 1.25 12 MM CU COAT. 6MY *	UNIVERSAL	68	50
0500 053 7	07129925738		SHEET-METAL NUT ST 4.8 MM GALV. CLR. PASSIV.	E81, E82, E87, E88, E36, E46, E90, E91, E92, E93, E34, E39, E60, E61, E32, E38, E65, E66, F01, F02, X3, X5, Z3, Z4, Z8	7	100
0500 053 7	07129901654		SHEET-METAL NUT ST 4.8 MM GALV. CLR. PASSIV.	E81, E82, E87, E88, E36, E46, E90, E91, E92, E93, E34, E39, E60, E61, E32, E38, E65, E66, F01, F02, X3, X5, Z3, Z4, Z8	7	100
0500 111 82	07129926306		SPRING NUT 4.0 MM GALV. CLR. PASSIV.	UNIVERSAL	23	100
0500 113 62	07129925709		SHEET-METAL NUT ST 4.2 MM GALV. CLR. PASSIV.	E81, E82, E87, E88, E36, E46, E90, E91, E92, E93, E34, E39, E60, E61, E32, E38, E65, E66, F01, F02, X3, X5, Z3, Z4	4	100
0500 113 62	07129901644		SHEET-METAL NUT ST 4.2 MM GALV. CLR. PASSIV.	E81, E82, E87, E88, E36, E46, E90, E91, E92, E93, E34, E39, E60, E61, E32, E38, E65, E66, F01, F02, X3, X5, Z3, Z4	4	100
0500 113 65	07129925713		SHEET-METAL NUT ST 4.8 MM GALV. CLR. PASSIV. MATT	E81, E82, E87, E88, E36, E46, E90, E91, E92, E93, E34, E39, E60, E61, E32, E38, E65, E66, F01, F02, X3, X5, Z3, Z4	6	50
0500 113 65	07129901649		SHEET-METAL NUT ST 4.8 MM GALV. CLR. PASSIV. MATT	E81, E82, E87, E88, E36, E46, E90, E91, E92, E93, E34, E39, E60, E61, E32, E38, E65, E66, F01, F02, X3, X5, Z3, Z4	6	50
0500 113 69			SHEET-METAL NUT ST 6.3 MM GALV. CLR. PASSIV. MATT	UNIVERSAL	9	100
0500 114 04	07129925743		SHEET-METAL NUT ST 6.3 MM GALV. CLR. PASSIV. MATT	E81, E82, E87, E88, E36, E46, E90, E91, E92, E93, E34, E39, E60, E61, E32, E38, E65, E66, F01, F02, X3, X5, Z3, Z4	10	100
0500 114 27	07129925742		SHEET-METAL NUT ST 6.3 MM GALV.	E81, E82, E87, E88, E36, E46, E90, E91, E92, E93, E34, E39, E60, E61, E32, E38, E65, E66, F01, F02, X3, X5, Z3, Z4	13	100
0500 114 27	07129901663		SHEET-METAL NUT ST 6.3 MM GALV.	E81, E82, E87, E88, E36, E46, E90, E91, E92, E93, E34, E39, E60, E61, E32, E38, E65, E66, F01, F02, X3, X5, Z3, Z4	13	100

Index sorted by Art. No.						
Art. No.	Orig. No.	Eurocode	Designation	Car type	Fig.	P. Qty.
0500 114 70	07129925737		SHEET-METAL NUT ST 4.8 MM GALV.	E81, E82, E87, E88, E36, E46, E90, E91, E92, E93, E34, E39, E60, E61, E32, E38, E65, E66, F01, F02, X3, X5, Z3, Z4	11	50
0500 114 70	07129901651		SHEET-METAL NUT ST 4.8 MM GALV.	E81, E82, E87, E88, E36, E46, E90, E91, E92, E93, E34, E39, E60, E61, E32, E38, E65, E66, F01, F02, X3, X5, Z3, Z4	11	50
0500 115 22	07129925712		SHEET-METAL NUT ST 4.8 MM GALV. CLR. PASSIV.	E81, E82, E87, E88, E36, E46, E90, E91, E92, E93, E34, E39, E60, E61, E32, E38, E65, E66, F01, F02, X3, X5, Z3, Z4	5	100
0500 115 77	07129925720		SHEET-METAL NUT ST 5.5 MM GALV. CLR. PASSIV. MATT	UNIVERSAL	8	100
0500 116 39	51416654189		PAPERBOARD CLIP GALV. CLR.	-	56	25
0500 116 67	07129925730		SHEET-METAL NUT ST 4.2 MM GALV. CLR. PASSIV.	E81, E82, E87, E88, E36, E46, E90, E91, E92, E93, E34, E39, E60, E61, E32, E38, E65, E66, F01, F02, X3, X5, Z3, Z4, Z8	12	100
0500 116 67	07129901645		SHEET-METAL NUT ST 4.2 MM GALV. CLR. PASSIV.	E81, E82, E87, E88, E36, E46, E90, E91, E92, E93, E34, E39, E60, E61, E32, E38, E65, E66, F01, F02, X3, X5, Z3, Z4, Z8	12	100
0500 117 07			GROMMET FOR LETTERING PE 181 CLR.	E39, E46	47	100
0500 117 61	07129925749		SHEET-METAL NUT ST. 8.0 GALV. CLR. PASSIV.	E81, E82, E87, E88, E36, E46, E90, E91, E92, E93, E34, E39, E60, E61, E32, E38, E65, E66, F01, F02, X3, X5, Z3, Z4	16	50
0500 126 96			PLASTIC SPLIT RIVET POM 309 NATURAL	E30	28	25
0500 127 98	51131816019		COLORLESS TRIM CLIP	-	58	50
0500 131 43	51471840961		TRIM CLIP FOR COVERS POM COLORLESS	E21, E23, E30, E36	59	50
0500 133 68	51131848664		TRIM CLIP	E23	60	50
0500 136 76	51411870718		INTERIOR LINING CLIP POM GREEN	E12, E23, E24, E28, E30, E46, E32	52	50
0500 185 2	51181852299		BLACK CLIP FOR LICENSE PLATE ATTACHMENT	E12, E21, E23, E24, E28, E30, E32, E34, E36, E39	46	50
0500 201 404	51471911992		PLASTIC SPLIT RIVET PA 6 BLACK	E30, E34, E36, E38, E39, E34, X5, E60, E65, E66, E67, Z3 / MINI: R56	39	25
0500 411	51711952019		PLASTIC BLIND RIVET 5.0 x 12.0 BLACK	E24	72	100
0500 523 14	51161881149		PLASTIC SPLIT RIVET PA12 BLACK	E81, E82, E87, E88, E36, E46, E90, E91, E92, E93, E34, E39, E60, E61, E65, E66 F01, F02, X5, X6, Z4	29	50
0500 533 12	51127070202		SHEET-METAL NUT M 6 MET. CORR. PROT. 2.2 SI GLIDE ADDIT.	E81, E82, E87, E88, E30, E36, E46, E90, E91, E92, E93, E94, E34, E39, E60, E61, E63, E64, E62, E38, E65, E66, F01, F02, E31, X3, X5, X6, Z3, Z4, Z8	17	100

Index sorted by Art. No.						
Art. No.	Orig. No.	Eurocode	Designation	Car type	Fig.	P. Qty.
0500 909 93	12321276231		CABLE TIE FOR T-BOLT	E30, E34	24	50
0500 910 1	51135680113		COLORLESS EXPANDING NUT	E21, E12, E28, E23	45	25
0500 914 2	51131804205		BLACK TRIM CLIP	E21	57	100
0500 929 6	51131848312		COLORLESS TRIM CLIP	E24, E28	61	100
0500 965	51311938494	2426AKCS1G 2426ASCS	WINDOW CLIP WITH ADHESIVE STRIP	E30, E32, E34	78	25
0500 965	51318177850	2426AKCS1G 2426ASCS	WINDOW CLIP WITH ADHESIVE STRIP	E30, E32, E34	78	25
0501 101 000	51471916670		PLASTIC SPLIT RIVET PA66 BK	E36	30	100
0501 103 057	51111835624		WASHER NUT M 6 GALV.	E30, E36, E46, E34, E39, E32, E38, E31, X3, X5, Z3, Z8	43	25
0501 104 039			THREADED BLIND RIVET FOR WHEEL INSTAL. PARTI. WALL	E31, E32, E34, E36	73	50
0501 104 050	51711958025		PLASTIC NUT WHEEL INSTAL. PARTI. WALL PA 6 GF 30 BLACK	E81, E82, E87, E88, E36, E46, E90, E91, E92, E93, E32, E65, E66, X3, X5, X6, Z3, Z4	27	100
0501 104 051	16131176747		PLASTIC NUT TUNNEL COVER	E81, E82, E87, E88, E36, E46, E90, E91, E92, E93, E34, E39, E60, E61, E32, E38, E65, E66, F01, F02, X3, X5, Z3, Z4; X6, Z8	26	100
0501 104 117	63171367868		COLORLESS EXPANDING NUT	E81, E82, E87, E88, E36, E46, E90, E91, E92, E93, E34, E39, E60, E61, E32, E38, E65, E66, F01, F02, X3, X5, X6, Z3, Z4	44	100
0501 105 004	61131386642		BLACK CABLE TIE	E36, E34, E39, E32, E38, E31, X5	25	25
0501 105 006	51131960054		COLORLESS TRIM CLIP	E36, E46	62	50
0501 105 015	51321938884	2431LSCSFD	WINDOW LIFT CLIP BMW*	E32, E34, E36, M40, Z3, Z4	76	20
0501 105 016	51481938725		PLASTIC SPLIT RIVET WITH CAP 6:6 MM DIA. PA 66 BLACK	E30, E32, E34, E38, E39, Z3	40	50
0501 105 017	51718108613	2433ASCSB	PLASTIC CLIP FOR TRIM GRID E31 E36	E31, E34, E36, E38	33	100
0501 105 020	51712234032		TRIM CLIP FOR ROCKER PANEL COVER POM 500 COLORLESS	E36	65	50
0501 105 035	51481884779		PLASTIC SPLIT RIVET PA6 BLACK	E28, E30, E39	34	50
0501 105 041	51711928946	2426AKCS2G 2426ASSS	PLASTIC SPLIT RIVET FOR WINDOW COVER E34	E32, E34	32	100
0501 105 045	51441854624		PLASTIC RIVET WITHOUT PIN	E23, E30, E31, E32, E34, E38, Z3	42	25
0501 105 063	51111944537		PLASTIC SPLIT RIVET FOR BUMPER PA 66 BLACK	E81, E82, E87, E88, E36, E46, E34, E39, E32, E38, X3, X5, Z3, Z8	35	50
0501 105 064	51111908077		PLASTIC SPLIT RIVET FOR BUMPER PA 66 BLACK	E30, E32, E34, E36, E38, E39, E46, X5, E60, E65, E66, E67, Z4, Z3 MINI: R50, R52, R53, R56	36	50

Index sorted by Art. No.						
Art. No.	Orig. No.	Eurocode	Designation	Car type	Fig.	P. Qty.
0501 105 065	51111964186		PLASTIC SPLIT RIVET PA 66 BLACK	E30 ,E36, E38, E39, E46, E60, X5	37	50
0501 105 065			PLASTIC SPLIT RIVET PA 66 BLACK	E30 ,E36, E38, E39, E46, E60, X5	37	50
0501 105 065			PLASTIC SPLIT RIVET PA 66 BLACK	E30 ,E36, E38, E39, E46, E60, X5	37	50
0501 105 068	51141807495		BLACK GROMMET	E81, E82, E87, E88, E36, E46, E90, E91, E92, E93, E34, E39, E60, E61, E32, E38, E65, E66, F01, F02, X3, X5, Z3, Z4, Z8	48	100
0501 105 073	07129901656		SHEET-METAL NUT ST 4.8 MM MET. CORR. PROT. 2.1 SI	E81, E82, E87, E88, E36, E46, E90, E91, E92, E93, E34, E39, E60, E61, E32, E38, E65, E66, F01, F02, X3, X5, Z3, Z4	15	100
0501 105 073	07129925734		SHEET-METAL NUT ST 4.8 MM MET. CORR. PROT. 2.1 SI	E81, E82, E87, E88, E36, E46, E90, E91, E92, E93, E34, E39, E60, E61, E32, E38, E65, E66, F01, F02, X3, X5, Z3, Z4	15	100
0501 105 078	51118174185		PLASTIC SPLIT RIVET FOR BUMPER PA 66 BLACK	E38, E39, E46, X5, Z3, Z4	38	50
0501 105 082	51488181420		COVER PLUG BLACK PA 6.6	E32, E34, E36, E38	2	50
0501 105 083	52532308647		SHEET-METAL NUT M 5 GALV. CLR. PASSIV.	E32	14	25
0501 105 084	51718195811	2431AKCSB1F 2431ASCSB6B	PLASTIC SPLIT RIVET BLACK PA 6.6 + PE	E38, E39, E46, X5, Z3, Z4 / MINI: R50, R52, R53, R56	31	50
0501 105 085	07147145753	2440ASCHS 2455ASCHS	INTERIOR LINING CLIP POM COLORLESS	F01, F02, Z4	55	25
0501 105 086	51481915964		THREADED BLIND RIVET PA 6 BLACK	E81, E82, E87, E88 36, E46, E90, E91, E92, E93, E34, E39, E60, E61, E32, E38, E65, E66, X5, X6, Z3, Z4, Z8	75	50
0501 105 087	07147122912		SPECIAL PART RIVET BODY POM BK	E81, E82, E87, E88, E90, E91, E92, E93, X6	85	50
0501 105 088	07147122913		SPECIAL PART RIVET PIN POM BLACK	E81, E82, E87, E88, E90, E91, E92, E93, X6	84	100
0501 105 089	51777166869		TRIM CLIP POM YELLOW	E90, E91	64	50
0501 105 108	07129925707		SHEET-METAL NUT ST 3.9 MM GALV. CLR. PASSIV.	E81, E82, E87, E88, E36, E46, E90, E91, E92, E93, E34, E39, E60, E61, E32, E38, E65, E66, F01, F02, X3, X5, Z3, Z4	18	100
0501 105 109	07129925727		SHEET-METAL NUT ST 3.9 MM GALV. CLR. PASSIV.	E81, E82, E87, E88, E36, E46, E90, E91, E92, E93, E34, E39, E60, E61, E32, E38, E65, E66, F01, F02, X3, X5, Z3, Z4	19	100
0501 105 111	51131872146		BLACK TRIM GRID CLIP	E21, E28, E30	21	25
0501 105 113	07129926302		SPRING NUT 3.0 MM GALV.	UNIVERSAL	22	100
0501 105 117	51498166702		PLASTIC SPLIT RIVET PA 66 BK	E36 E38 E39 E46 E65 E66 E67 Z3	41	100
0501 105 119	51131870459		GROMMET PE LD NATURAL	E28, E30, E31, E32, E34	49	25
0501 105 120	51711932996		GROMMET FOR TRIM CLIP PA 661 GREEN	UNIVERSAL	50	50

Index sorted by Art. No.						
Art. No.	Orig. No.	Eurocode	Designation	Car type	Fig.	P. Qty.
0501 105 121	52201964201		FIR-TREE CLIP PA 66 BLACK	E81, E82, E87, E88, E32, E34, E36, E38, E46, E90, E91, E91, X3, X5, Z4	3	100
0501 105 122	11127534165		SHEET-METAL NUT FOR QUICK RELEASE SCREW	E87, E90, E91, E60, E61, E65, E66, Z4	20	100
0501 105 123	51418172050		INTERIOR LINING CLIP POM YELLOW	E39, Z8	54	100
0501 105 124	51717002953		PLASTIC BLIND RIVET 5.8 X 19.3 BLACK PA 12/POM	E90, E91, X3, X5, X6, Z4	71	25
0501 105 125	51218205295	2434ASCSB	BLACK THREADED BLIND RIVET	E39, X5	74	100
0501 105 126	11127531561		QUICK-RELEASE SCREW 5.0x16.6 MET. CORR. PROT. SI	E87, E90, E91, E60, E61, E63, E64, E65, E66, Z4	70	100
0501 105 400	51411973500		INTERIOR LINING CLIP POM COLORLESS	E36, E46, E34, E39, E38, X5, Z3, Z8	53	100
0501 105 401	51131946258		TRIM CLIP FOR DOOR BUMPER STRIP E34	E34	63	100
0501 105 601	51471904317		BLACK FIR-TREE CLIP	E23, E24, E28	1	25
0501 305 001	51318150943	2433ASCSB6B	GROMMET FOR DECORATIVE MOLDING SIDE WINDOWS PA 66	E81, E82, E46, E92, E93, E63, E64, E38, X5	51	25
0501 305 002	51317064098	2445ASCSS	WINDOW CLIP BLACK + U-CLIP MET. CORR. PROT. SI	E60, E61	82	25
0501 305 003	51138174852	2433ASSS	RECURSION RIVET POM 107 BLACK	E38	83	25
0501 305 004	52311938494	2426ASCS1	TRIM CLIP FRONT WINDOW POM 500 GRAY	E34, E32	66	25
0501 305 005	51313401691	2449ASCRC	BLACK WINDOW CLIP POM/METAL SILVER	X3	81	25
0501 305 005	51313448374	2449ASCRC	BLACK WINDOW CLIP POM/METAL SILVER	X3	81	25
0501 305 006	51137145109	2447ASCSS1B	BLACK WINDOW CLIP POM/METAL SILVER	E90, E91	77	25
0501 305 007	51137145110	2447ASCSS	COLORLESS WINDOW CLIP POM/METAL SILVER	E90, E91	79	25
0501 305 008	51137172103	2447ASCSS2B	GREEN WINDOW CLIP POM/METAL SILVER	E90, E91	80	25

Index sorted by Orig. No.						
Orig. No.	Art. No.	Eurocode	Designation	Car type	Fig.	P. Qty.
	0500 113 69		SHEET-METAL NUT ST 6.3 MM GALV. CLR. PASSIV. MATT	UNIVERSAL	9	100
07129901656	0501 105 073		SHEET-METAL NUT ST 4.8 MM MET. CORR. PROT. 2.1 SI	E81, E82, E87, E88, E36, E46, E90, E91, E92, E93, E34, E39, E60, E61, E32, E38, E65, E66, F01, F02, X3, X5, Z3, Z4	15	100
07129925734	0501 105 073		SHEET-METAL NUT ST 4.8 MM MET. CORR. PROT. 2.1 SI	E81, E82, E87, E88, E36, E46, E90, E91, E92, E93, E34, E39, E60, E61, E32, E38, E65, E66, F01, F02, X3, X5, Z3, Z4	15	100
07129925707	0501 105 108		SHEET-METAL NUT ST 3.9 MM GALV. CLR. PASSIV.	E81, E82, E87, E88, E36, E46, E90, E91, E92, E93, E34, E39, E60, E61, E32, E38, E65, E66, F01, F02, X3, X5, Z3, Z4	18	100
07129925709	0500 113 62		SHEET-METAL NUT ST 4.2 MM GALV. CLR. PASSIV.	E81, E82, E87, E88, E36, E46, E90, E91, E92, E93, E34, E39, E60, E61, E32, E38, E65, E66, F01, F02, X3, X5, Z3, Z4	4	100
07129901644	0500 113 62		SHEET-METAL NUT ST 4.2 MM GALV. CLR. PASSIV.	E81, E82, E87, E88, E36, E46, E90, E91, E92, E93, E34, E39, E60, E61, E32, E38, E65, E66, F01, F02, X3, X5, Z3, Z4	4	100
07129925712	0500 115 22		SHEET-METAL NUT ST 4.8 MM GALV. CLR. PASSIV.	E81, E82, E87, E88, E36, E46, E90, E91, E92, E93, E34, E39, E60, E61, E32, E38, E65, E66, F01, F02, X3, X5, Z3, Z4	5	100
07129925713	0500 113 65		SHEET-METAL NUT ST 4.8 MM GALV. CLR. PASSIV. MATT	E81, E82, E87, E88, E36, E46, E90, E91, E92, E93, E34, E39, E60, E61, E32, E38, E65, E66, F01, F02, X3, X5, Z3, Z4	6	50
07129901649	0500 113 65		SHEET-METAL NUT ST 4.8 MM GALV. CLR. PASSIV. MATT	E81, E82, E87, E88, E36, E46, E90, E91, E92, E93, E34, E39, E60, E61, E32, E38, E65, E66, F01, F02, X3, X5, Z3, Z4	6	50
07129925720	0500 115 77		SHEET-METAL NUT ST 5.5 MM GALV. CLR. PASSIV. MATT	UNIVERSAL	8	100
07129925727	0501 105 109		SHEET-METAL NUT ST 3.9 MM GALV. CLR. PASSIV.	E81, E82, E87, E88, E36, E46, E90, E91, E92, E93, E34, E39, E60, E61, E32, E38, E65, E66, F01, F02, X3, X5, Z3, Z4	19	100
07129925730	0500 116 67		SHEET-METAL NUT ST 4.2 MM GALV. CLR. PASSIV.	E81, E82, E87, E88, E36, E46, E90, E91, E92, E93, E34, E39, E60, E61, E32, E38, E65, E66, F01, F02, X3, X5, Z3, Z4, Z8	12	100
07129901645	0500 116 67		SHEET-METAL NUT ST 4.2 MM GALV. CLR. PASSIV.	E81, E82, E87, E88, E36, E46, E90, E91, E92, E93, E34, E39, E60, E61, E32, E38, E65, E66, F01, F02, X3, X5, Z3, Z4, Z8	12	100

Index sorted by Orig. No.						
Orig. No.	Art. No.	Eurocode	Designation	Car type	Fig.	P. Qty.
07129925737	0500 114 70		SHEET-METAL NUT ST 4.8 MM GALV.	E81, E82, E87, E88, E36, E46, E90, E91, E92, E93, E34, E39, E60, E61, E32, E38, E65, E66, F01, F02, X3, X5, Z3, Z4	11	50
07129901651	0500 114 70		SHEET-METAL NUT ST 4.8 MM GALV.	E81, E82, E87, E88, E36, E46, E90, E91, E92, E93, E34, E39, E60, E61, E32, E38, E65, E66, F01, F02, X3, X5, Z3, Z4	11	50
07129925738	0500 053 7		SHEET-METAL NUT ST 4.8 MM GALV. CLR. PASSIV.	E81, E82, E87, E88, E36, E46, E90, E91, E92, E93, E34, E39, E60, E61, E32, E38, E65, E66, F01, F02, X3, X5, Z3, Z4, Z8	7	100
07129901654	0500 053 7		SHEET-METAL NUT ST 4.8 MM GALV. CLR. PASSIV.	E81, E82, E87, E88, E36, E46, E90, E91, E92, E93, E34, E39, E60, E61, E32, E38, E65, E66, F01, F02, X3, X5, Z3, Z4, Z8	7	100
07129925742	0500 114 27		SHEET-METAL NUT ST 6.3 MM GALV.	E81, E82, E87, E88, E36, E46, E90, E91, E92, E93, E34, E39, E60, E61, E32, E38, E65, E66, F01, F02, X3, X5, Z3, Z4	13	100
07129901663	0500 114 27		SHEET-METAL NUT ST 6.3 MM GALV.	E81, E82, E87, E88, E36, E46, E90, E91, E92, E93, E34, E39, E60, E61, E32, E38, E65, E66, F01, F02, X3, X5, Z3, Z4	13	100
07129925743	0500 114 04		SHEET-METAL NUT ST 6.3 MM GALV. CLR. PASSIV. MATT	E81, E82, E87, E88, E36, E46, E90, E91, E92, E93, E34, E39, E60, E61, E32, E38, E65, E66, F01, F02, X3, X5, Z3, Z4	10	100
07129925749	0500 117 61		SHEET-METAL NUT ST. 8.0 GALV. CLR. PASSIV.	E81, E82, E87, E88, E36, E46, E90, E91, E92, E93, E34, E39, E60, E61, E32, E38, E65, E66, F01, F02, X3, X5, Z3, Z4	16	50
07129926302	0501 105 113		SPRING NUT 3.0 MM GALV.	UNIVERSAL	22	100
07129926306	0500 111 82		SPRING NUT 4.0 MM GALV. CLR. PASSIV.	UNIVERSAL	23	100
07147122912	0501 105 087		SPECIAL PART RIVET BODY POM BK	E81, E82, E87, E88, E90, E91, E92, E93, X6	85	50
07147122913	0501 105 088		SPECIAL PART RIVET PIN POM BLACK	E81, E82, E87, E88, E90, E91, E92, E93, X6	84	100
07147145753	0501 105 085	2440ASCHS 2455ASCHS	INTERIOR LINING CLIP POM COLORLESS	F01, F02, Z4	55	25
11127531561	0501 105 126		QUICK-RELEASE SCREW 5.0x16.6 MET. CORR. PROT. SI	E87, E90, E91, E60, E61, E63, E64, E65, E66, Z4	70	100
11127534165	0501 105 122		SHEET-METAL NUT FOR QUICK RELEASE SCREW	E87, E90, E91, E60, E61, E65, E66, Z4	20	100
11621304755	0366 1		SLOTTED NUT 14441 M 6 x 1 9 MM CU COAT. 6MY *	E24, E28, E30, E34	67	100

Index sorted by Orig. No.						
Orig. No.	Art. No.	Eurocode	Designation	Car type	Fig.	P. Qty.
11621711954	0365 8		SELF-LOCKING FLANGED NUT M 8 12 MM CU COAT.*	E81, E82, E87, E88, E36, E46, E90, E91, E92, E93, E34, E39, E60, E61, E32, E38, Z3, Z4	69	100
11621744323	0366 2		SLOTTED NUT 14441 M 8 x 1.25 12 MM CU COAT. 6MY *	UNIVERSAL	68	50
12321276231	0500 909 93		CABLE TIE FOR T-BOLT	E30, E34	24	50
16131176747	0501 104 051		PLASTIC NUT TUNNEL COVER	E81, E82, E87, E88, E36, E46, E90, E91, E92, E93, E34, E39, E60, E61, E32, E38, E65, E66, F01, F02, X3, X5, Z3, Z4; X6, Z8	26	100
51111835624	0501 103 057		WASHER NUT M 6 GALV.	E30, E36, E46, E34, E39, E32, E38, E31, X3, X5, Z3, Z8	43	25
51111908077	0501 105 064		PLASTIC SPLIT RIVET FOR BUMPER PA 66 BLACK	E30, E32, E34, E36, E38, E39, E46, X5, E60, E65, E66, E67, Z4, Z3 MINI: R50, R52, R53, R56	36	50
51111944537	0501 105 063		PLASTIC SPLIT RIVET FOR BUMPER PA 66 BLACK	E81, E82, E87, E88, E36, E46, E34, E39, E32, E38, X3, X5, Z3, Z8	35	50
51111964186	0501 105 065		PLASTIC SPLIT RIVET PA 66 BLACK	E30 ,E36, E38, E39, E46, E60, X5	37	50
	0501 105 065		PLASTIC SPLIT RIVET PA 66 BLACK	E30 ,E36, E38, E39, E46, E60, X5	37	50
	0501 105 065		PLASTIC SPLIT RIVET PA 66 BLACK	E30 ,E36, E38, E39, E46, E60, X5	37	50
51118174185	0501 105 078		PLASTIC SPLIT RIVET FOR BUMPER PA 66 BLACK	E38, E39, E46, X5, Z3, Z4	38	50
51127070202	0500 533 12		SHEET-METAL NUT M 6 MET. CORR. PROT. 2.2 SI GLIDE ADDIT.	E81, E82, E87, E88, E30, E36, E46, E90, E91, E92, E93, E94, E34, E39, E60, E61, E63, E64, E62, E38, E65, E66, F01, F02, E31, X3, X5, X6, Z3, Z4, Z8	17	100
51131804205	0500 914 2		BLACK TRIM CLIP	E21	57	100
51131816019	0500 127 98		COLORLESS TRIM CLIP	-	58	50
51131848312	0500 929 6		COLORLESS TRIM CLIP	E24, E28	61	100
51131848664	0500 133 68		TRIM CLIP	E23	60	50
51131870459	0501 105 119		GROMMET PE LD NATURAL	E28, E30, E31, E32, E34	49	25
51131872146	0501 105 111		BLACK TRIM GRID CLIP	E21, E28, E30	21	25
51131946258	0501 105 401		TRIM CLIP FOR DOOR BUMPER STRIP E34	E34	63	100
51131960054	0501 105 006		COLORLESS TRIM CLIP	E36, E46	62	50
51135680113	0500 910 1		COLORLESS EXPANDING NUT	E21, E12, E28, E23	45	25
51137145109	0501 305 006	2447ASCSS1B	BLACK WINDOW CLIP POM/METAL SILVER	E90, E91	77	25
51137145110	0501 305 007	2447ASCSS	COLORLESS WINDOW CLIP POM/METAL SILVER	E90, E91	79	25
51137172103	0501 305 008	2447ASCSS2B	GREEN WINDOW CLIP POM/METAL SILVER	E90, E91	80	25
51138174852	0501 305 003	2433ASSS	RECURSION RIVET POM 107 BLACK	E38	83	25

Index sorted by Orig. No.						
Orig. No.	Art. No.	Eurocode	Designation	Car type	Fig.	P. Qty.
51141807495	0501 105 068		BLACK GROMMET	E81, E82, E87, E88, E36, E46, E90, E91, E92, E93, E34, E39, E60, E61, E32, E38, E65, E66, F01, F02, X3, X5, Z3, Z4, Z8	48	100
51161881149	0500 523 14		PLASTIC SPLIT RIVET PA12 BLACK	E81, E82, E87, E88, E36, E46, E90, E91, E92, E93, E34, E39, E60, E61, E65, E66 F01, F02, X5, X6, Z4	29	50
51181852299	0500 185 2		BLACK CLIP FOR LICENSE PLATE ATTACHMENT	E12, E21, E23, E24, E28, E30, E32, E34, E36, E39	46	50
51218205295	0501 105 125	2434ASCSB	BLACK THREADED BLIND RIVET	E39, X5	74	100
51311938494	0500 965	2426AKCS1G 2426ASCS	WINDOW CLIP WITH ADHESIVE STRIP	E30, E32, E34	78	25
51318177850	0500 965	2426AKCS1G 2426ASCS	WINDOW CLIP WITH ADHESIVE STRIP	E30, E32, E34	78	25
51313401691	0501 305 005	2449ASCERS	BLACK WINDOW CLIP POM/METAL SILVER	X3	81	25
51313448374	0501 305 005	2449ASCERS	BLACK WINDOW CLIP POM/METAL SILVER	X3	81	25
51317064098	0501 305 002	2445ASCSS	BLACK WINDOW CLIP + U-CLIP MET. CORR. PROT. SI	E60, E61	82	25
51318150943	0501 305 001	2433ASCSB6B	GROMMET FOR DECORATIVE MOLDING SIDE WINDOWS PA 66	E81, E82, E46, E92, E93, E63, E64, E38, X5	51	25
51321938884	0501 105 015	2431LSCSFD	WINDOW LIFT CLIP BMW*	E32, E34, E36, M40, Z3, Z4	76	20
51411870718	0500 136 76		INTERIOR LINING CLIP POM GREEN	E12, E23, E24, E28, E30, E46, E32	52	50
51411973500	0501 105 400		INTERIOR LINING CLIP POM COLORLESS	E36, E46, E34, E39, E38, X5, Z3, Z8	53	100
51416654189	0500 116 39		PAPERBOARD CLIP GALV. CLR.	-	56	25
51418172050	0501 105 123		INTERIOR LINING CLIP POM YELLOW	E39, Z8	54	100
51441854624	0501 105 045		PLASTIC RIVET WITHOUT PIN	E23, E30, E31, E32, E34, E38, Z3	42	25
51471840961	0500 131 43		TRIM CLIP FOR COVERS POM COLORLESS	E21, E23, E30, E36	59	50
51471904317	0501 105 601		BLACK FIR-TREE CLIP	E23, E24, E28	1	25
51471911992	0500 201 404		PLASTIC SPLIT RIVET PA 6 BLACK	E30, E34, E36, E38, E39, E34, X5, E60, E65, E66, E67, Z3 / MINI: R56	39	25
51471916670	0501 101 000		PLASTIC SPLIT RIVET PA66 BK	E36	30	100
51481884779	0501 105 035		PLASTIC SPLIT RIVET PA6 BLACK	E28, E30, E39	34	50
51481915964	0501 105 086		THREADED BLIND RIVET PA 6 BLACK	E81, E82, E87, E88 36, E46, E90, E91, E92, E93, E34, E39, E60, E61, E32, E38, E65, E66, X5, X6, Z3, Z4, Z8	75	50
51481938725	0501 105 016		PLASTIC SPLIT RIVET WITH CAP 6:6 MM DIA. PA 66 BLACK	E30, E32, E34, E38, E39, Z3	40	50
51488181420	0501 105 082		COVER PLUG BLACK PA 6.6	E32, E34, E36, E38	2	50
51498166702	0501 105 117		PLASTIC SPLIT RIVET PA 66 BK	E36 E38 E39 E46 E65 E66 E67 Z3	41	100
51711928946	0501 105 041	2426AKCS2G 2426ASSS	PLASTIC SPLIT RIVET FOR WINDOW COVER E34	E32, E34	32	100
51711932996	0501 105 120		GROMMET FOR TRIM CLIP PA 661 GREEN	UNIVERSAL	50	50

Index sorted by Orig. No.						
Orig. No.	Art. No.	Eurocode	Designation	Car type	Fig.	P. Qty.
51711952019	0500 411		PLASTIC BLIND RIVET 5.0 x 12.0 BLACK	E24	72	100
51711958025	0501 104 050		PLASTIC NUT WHEEL INSTAL. PARTI. WALL PA 6 GF 30 BLACK	E81, E82, E87, E88, E36, E46, E90, E91, E92, E93, E32, E65, E66, X3, X5, X6, Z3, Z4	27	100
51712234032	0501 105 020		TRIM CLIP FOR ROCKER PANEL COVER POM 500 COLORLESS	E36	65	50
51717002953	0501 105 124		PLASTIC BLIND RIVET 5.8 X 19.3 BLACK PA 12/POM	E90, E91, X3, X5, X6, Z4	71	25
51718108613	0501 105 017	2433ASCSB	PLASTIC CLIP FOR TRIM GRID E31 E36	E31, E34, E36, E38	33	100
51718195811	0501 105 084	2431AKCSB1F 2431ASCSB6B	PLASTIC SPLIT RIVET BLACK PA 6.6 + PE	E38, E39, E46, X5, Z3, Z4 / MINI: R50, R52, R53, R56	31	50
51777166869	0501 105 089		TRIM CLIP POM YELLOW	E90, E91	64	50
52201964201	0501 105 121		FIR-TREE CLIP PA 66 BLACK	E81, E82, E87, E88, E32, E34, E36, E38, E46, E90, E91, E91, X3, X5, Z4	3	100
52311938494	0501 305 004	2426ASCS1	TRIM CLIP FRONT WINDOW POM 500 GRAY	E34, E32	66	25
52532308647	0501 105 083		SHEET-METAL NUT M 5 GALV. CLR. PASSIV.	E32	14	25
61131386642	0501 105 004		BLACK CABLE TIE	E36, E34, E39, E32, E38, E31, X5	25	25
63171367868	0501 104 117		COLORLESS EXPANDING NUT	E81, E82, E87, E88, E36, E46, E90, E91, E92, E93, E34, E39, E60, E61, E32, E38, E65, E66, F01, F02, X3, X5, X6, Z3, Z4	44	100

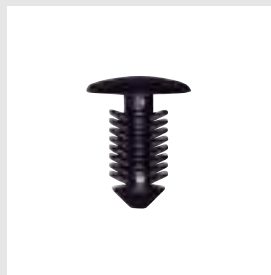

Art. No. 0500 939 5
 Orig. No.: 8964.57
 Fig. No.: 1

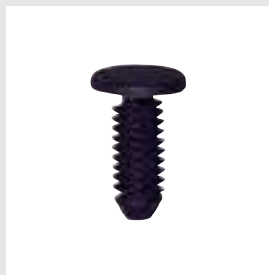

Art. No. 0500 682 9
 Orig. No.: 6995.15
 Fig. No.: 2

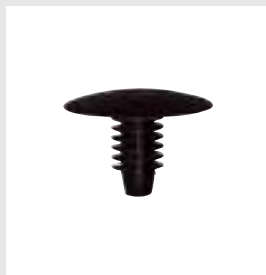

Art. No. 0500 680 3
 Orig. No.: 6999.T1
 Fig. No.: 3



Art. No. 0501 167 008
 Orig. No.: 7518.N8
 Fig. No.: 4

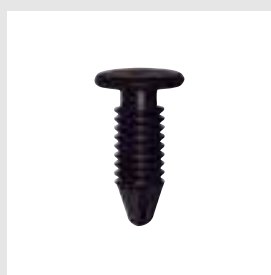

Art. No. 0501 121 103
 Orig. No.: 8326.N4
 7903077167
 Fig. No.: 5



Art. No. 0501 121 104
 Orig. No.: 6995.V6
 Fig. No.: 6

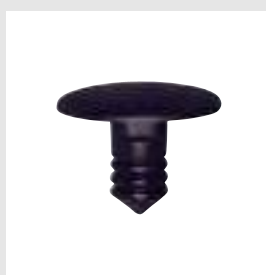

Art. No. 0501 121 105
 Orig. No.: 6983.05
 7568.HO
 96183626XT
 Fig. No.: 7

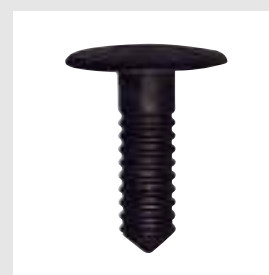

Art. No. 0501 121 106
 Orig. No.: 6983.17
 8964.77
 Fig. No.: 8

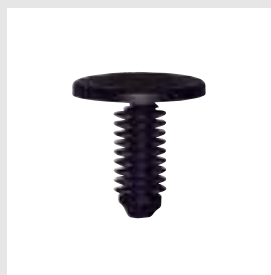

Art. No. 0501 121 107
 Orig. No.: 6992.95
 6999.R2
 Fig. No.: 9

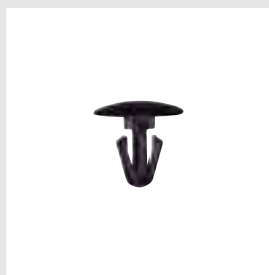

Art. No. 0501 121 108
 Orig. No.: 6992.K8
 6999.A3
 Fig. No.: 10

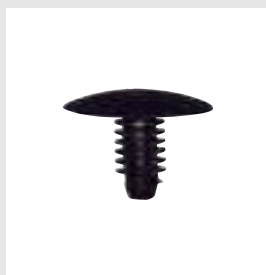

Art. No. 0501 121 109
 Orig. No.: 6992.C6
 Fig. No.: 11

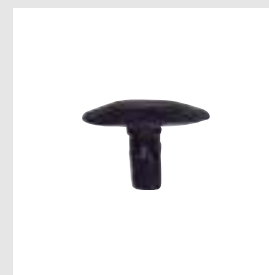

Art. No. 0501 121 110
 Orig. No.: 6997.86
 Fig. No.: 12

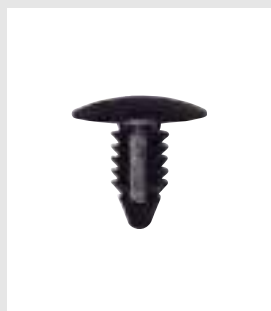

Art. No. 0501 121 111
 Orig. No.: 7518.CO
 Fig. No.: 13



Art. No. 0501 102 001
 Orig. No.: 9699583680
 Fig. No.: 14

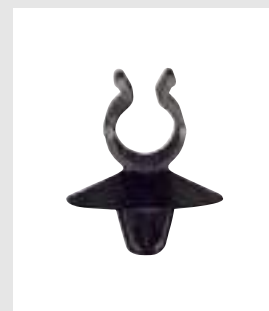

Art. No. 0501 121 115
 Orig. No.: 9623883980
 Fig. No.: 15



Art. No. 0501 121 112
 Orig. No.: 9614248780
 Fig. No.: 16



Art. No. 0501 121 113
 Orig. No.: 9616667880
 Fig. No.: 17



Art. No. 0501 121 114
 Orig. No.: 9605351680
 Fig. No.: 18



Art. No. 0500 531 64
 Orig. No.: 7903079004
 Fig. No.: 19



Art. No. 0501 121 116
 Orig. No.: 9628305780
 Fig. No.: 20



Art. No. 0500 523 14
 Orig. No.: 7903072170
 Fig. No.: 21



Art. No. 0501 121 117
 Orig. No.: 9642874480
 6991.X7
 Fig. No.: 22



Art. No. 0500 124 28
 Orig. No.: 7903072116
 Fig. No.: 23



Art. No. 0500 40
 Orig. No.: 7813.24
 Eurocode: 6539ASSHB
 Fig. No.: 24



Art. No. 0501 121 118
 Orig. No.: 9608351380
 6972.24
 Eurocode: 6539ASSH
 Fig. No.: 25



Art. No. 0501 105 117
 Orig. No.: 9640855880
 Fig. No.: 26

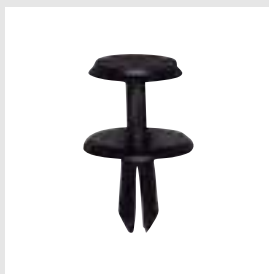

Art. No. 0501 121 120
 Orig. No.: Z000327504
 Fig. No.: 27



Art. No. 0500 718
 Orig. No.: 697202
 Fig. No.: 28



Art. No. 0501 121 121
 Orig. No.: 6997.83
 Fig. No.: 29



Art. No. 0501 121 190
 Orig. No.: 9648975680
 8565.53
 Fig. No.: 30



Art. No. 0501 121 191
 Orig. No.: 6973.24
 6973.34
 Fig. No.: 31

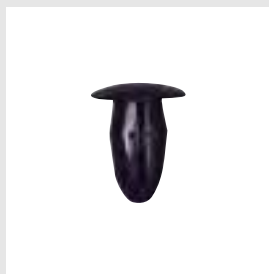

Art. No. 0501 121 122
 Orig. No.: 6547.20
 Fig. No.: 32

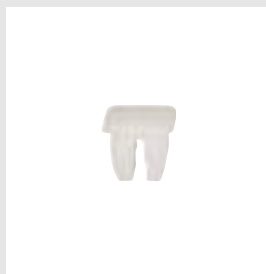

Art. No. 0501 121 123
 Orig. No.: 9629041880
 Fig. No.: 33

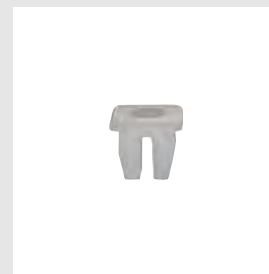

Art. No. 0501 167 059
 Orig. No.: 6987.A7
 Fig. No.: 34



Art. No. 0501 121 124
 Orig. No.:
 Fig. No.: 35



Art. No. 0501 121 125
 Orig. No.: 6992.80
 Fig. No.: 36



Art. No. 0500 117 07
 Orig. No.: 9629547080
 Fig. No.: 37



Art. No. 0501 121 126
 Orig. No.: 6995.N7
 Fig. No.: 38



Art. No. 0501 121 127
 Orig. No.: 8565.17
 Fig. No.: 39



Art. No. 0501 167 018
 Orig. No.: 6991.54
 Fig. No.: 40

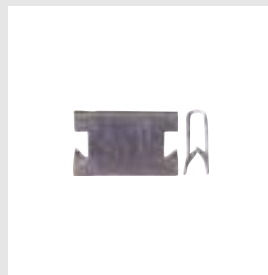

Art. No. 0500 515 10
 Orig. No.: 9616796
 Fig. No.: 41



Art. No. 0500 680 8
 Orig. No.: 6995.A3
 Fig. No.: 42



Art. No. 0501 121 128
 Orig. No.: 6992.82
 Fig. No.: 43



Art. No. 0501 121 129
 Orig. No.: 6990.50
 Fig. No.: 44



Art. No. 0501 121 130
 Orig. No.: 6991.S6
 Eurocode: 2730ASCTS1B
 Fig. No.: 45



Art. No. 0501 121 131
 Orig. No.: 6991.87
 Fig. No.: 46



Art. No. 0501 121 132
 Orig. No.: 6991.Y8
 Fig. No.: 47



Art. No. 0501 121 133
 Orig. No.: 6991.E8
 Fig. No.: 48



Art. No. 0501 121 134
 Orig. No.: 8565.40
 Eurocode: 6545ASCTB
 6539ASCHB
 Fig. No.: 49



Art. No. 0501 121 135
 Orig. No.: 6995.X3
 Fig. No.: 50



Art. No. 0501 121 136
 Orig. No.: 8565.34
 Fig. No.: 51



Art. No. 0501 121 137
 Orig. No.: 8565.35
 Fig. No.: 52



Art. No. 0501 321 002
 Orig. No.: 8110.24
 Eurocode: 6547ASCHS
 Fig. No.: 53



Art. No. 0501 121 192
 Orig. No.: 8123.96
 Eurocode: 2735ASCMS
 Fig. No.: 54

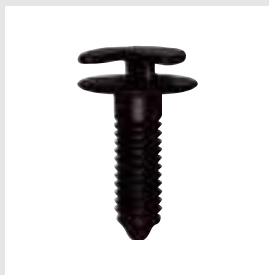

Art. No. 0501 321 003
 Orig. No.: 6995.50
 Eurocode: 2725ASCHB
 Fig. No.: 55



Art. No. 0500 671
 Orig. No.: 6995.02
 7903077112
 Fig. No.: 56

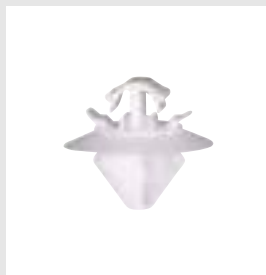

Art. No. 0501 121 146
 Orig. No.: 8565.48
 Fig. No.: 57



Art. No. 0501 121 138
 Orig. No.: 6974.04
 Fig. No.: 58



Art. No. 0362 121 25
 Orig. No.: 5405.55
 Fig. No.: 59



Art. No. 0501 121 139
 Orig. No.: 9613079480
 Fig. No.: 60



Art. No. 0501 121 140
 Orig. No.: 9699542280
 6555.LE
 Fig. No.: 61

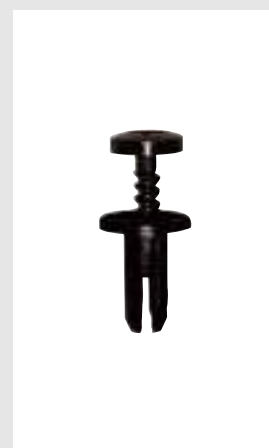

Art. No. 0501 121 141
 Orig. No.: 9630090980
 Fig. No.: 62



Art. No. 0501 321 008
 Orig. No.: 8123.64
 Eurocode: 6525ASCS
 Fig. No.: 63



Art. No. 0501 321 012
 Orig. No.: 8520.80
 Eurocode: 6520ASCH
 Fig. No.: 64



Art. No. 0501 321 009

Orig. No.: 96060797

Fig. No.: 65



Art. No. 0501 321 006

Orig. No.: 8123.90

Eurocode: 6544ASCSS1B

Fig. No.: 66



Art. No. 0501 321 004

Orig. No.: 8123.89

Eurocode: 6544ASCSS

Fig. No.: 67



Art. No. 0501 321 005

Orig. No.: 8123.91

Eurocode: 6544ASCSS2B

Fig. No.: 68



Art. No. 0501 321 010

Orig. No.: 8123.98

Fig. No.: 69



Art. No. 0501 321 007

Orig. No.: 8123.88

Eurocode: 2731ASCHS

Fig. No.: 70



Art. No. 0501 121 142
Orig. No.: 7030.16
9632676980
Fig. No.: 71



Art. No. 0501 121 143
Orig. No.: 7013.J0
Fig. No.: 72



Art. No. 0501 321 011
Orig. No.: 8123.65
Eurocode: 6525ASCSS
Fig. No.: 73



Art. No. 0501 121 144
Orig. No.: 9621997380
Fig. No.: 74



Art. No. 0501 121 145
Orig. No.: 7030.18
9632677180
Fig. No.: 75

Index sorted by Art. No.						
Art. No.	Orig. No.	Eurocode	Designation	Car type	Fig.	P. Qty.
0362 121 25	5405.55		WHEEL BOLT GEOMET SILVER M12X1.25X17 19 MM *	-	59	50
0500 117 07	9629547080		GROMMET FOR LETTERING PE 181 CLR.	205	37	100
0500 124 28	7903072116		PLASTIC SPLIT RIVET PA 122 BLACK *	-	23	50
0500 40	7813.24	6539ASSHB	PLASTIC SPLIT RIVET FOR LUGGAGE COMPARTMENT LINING PA 6 BLACK	206, 306, 406, XSARA	24	50
0500 515 10	9616796		U-CLIP GALV. CLR. PASSIV.	-	41	25
0500 523 14	7903072170		PLASTIC SPLIT RIVET PA12 BLACK	205	21	50
0500 531 64	7903079004		PLASTIC CABLE CLAMP 9.5 MM PA 6 GRAY	-	19	25
0500 671	6995.02		COLORLESS INTERIOR LINING CLIP	BX, 205, 309, 806, AX, ZX, XANTIA, XM, EVASION	56	25
0500 671	7903077112		COLORLESS INTERIOR LINING CLIP	BX, 205, 309, 806, AX, ZX, XANTIA, XM, EVASION	56	25
0500 680 3	6999.T1		COVER PLUG RENAULT/CITROËN POM BLACK	UNIVERSAL	3	50
0500 680 8	6995.A3		INTERIOR LINING CLIP FOR RENAULT/ CITROËN	106, 205, 306, 309, 405, 406, 605, 806, AX, BX, C15, EVASION	42	25
0500 682 9	6995.15		FIR-TREE CLIP PA 66 BLACK	ZX, SAXO, 106, 306 PHASE 2	2	50
0500 718	697202		PLASTIC SPLIT RIVET PA 66 BLACK	206, AX, BERLINGO	28	25
0500 939 5	8964.57		BLACK FIR-TREE CLIP	PICASSO, BERLINGO 1+2, 106 1+2, 205, 206, 306, 307 1+2, 405, 605 1+2, PARTNER 1+2	1	50
0501 102 001	9699583680		ROD RETAINER DIA. 7.0 - 21.0 MM POM BLACK	-	14	25
0501 105 117	9640855880		PLASTIC SPLIT RIVET PA 66 BK	-	26	100
0501 121 103	8326.N4		BLACK COVER PLUG	205 GTI, 806, AX, SAXO, BX, XSARA, PICASSO, XANTIA, XM	5	50
0501 121 103	7903077167		BLACK COVER PLUG	205 GTI, 806, AX, SAXO, BX, XSARA, PICASSO, XANTIA, XM	5	50
0501 121 104	6995.V6		COVER PLUG BLACK PA 6.6	C2, C5, BERLINGO, SAXO, XSARA II, XSARA PICASSO, 1007, 206, 207, PARTNER, RANCH	6	50
0501 121 105	6983.05		COVER PLUG PE LD BLACK	SAXO 1+2, XSARA 1+2, XSARA PICASSO, BERLINGO 1+2, 106 1+2, 205, 206, 207, 307 1+2, 308, 309, 405, 406 1+2, 206CC, PARTNER 1+2, BX, C4, C4 PICASSO, C15	7	100
0501 121 105	7568.HO		COVER PLUG PE LD BLACK	SAXO 1+2, XSARA 1+2, XSARA PICASSO, BERLINGO 1+2, 106 1+2, 205, 206, 207, 307 1+2, 308, 309, 405, 406 1+2, 206CC, PARTNER 1+2, BX, C4, C4 PICASSO, C15	7	100

Index sorted by Art. No.						
Art. No.	Orig. No.	Eurocode	Designation	Car type	Fig.	P. Qty.
0501 121 105	96183626XT		COVER PLUG PE LD BLACK	SAXO 1+2, XSARA 1+2, XSARA PICASSO, BERLINGO 1+2, 106 1+2, 205, 206, 207, 307 1+2, 308, 309, 405, 406 1+2, 206CC, PARTNER 1+2, BX, C4, C4 PICASSO, C15	7	100
0501 121 106	6983.17		BLACK COVER PLUG PE-LD	106, 205, 206, 405, 406, 605, AX, SAXO, C15	8	25
0501 121 106	8964.77		BLACK COVER PLUG PE-LD	106, 205, 206, 405, 406, 605, AX, SAXO, C15	8	25
0501 121 107	6992.95		BLACK COVER PLUG	UNIVERSAL, 106, 306, 405, 605, 806	9	50
0501 121 107	6999.R2		BLACK COVER PLUG	UNIVERSAL, 106, 306, 405, 605, 806	9	50
0501 121 108	6992.K8		BLACK COVER PLUG	SAXO, XSARA, XANTIA, BERLINGO, EVASION	10	25
0501 121 108	6999.A3		BLACK COVER PLUG	SAXO, XSARA, XANTIA, BERLINGO, EVASION	10	25
0501 121 109	6992.C6		COVER PLUG PA 66 BLACK	AX, XANTIA 1+2, C15, 106, 306 PHASE 1+2, 607 1+2, PARTNER, 206, 307 PHASE 2, 309, 406 1+2, 605 PHASE 2, SAXO, ZX, XSARA 1+2, XSARA PICASSO 1+2, C4, XM 1+2, BERLINGO PHASE 2	11	50
0501 121 110	6997.86		BLACK COVER PLUG	PICASSO, C8, 206, 307, 306, 807, C4, BERLINGO, SAXO, XANTIA, XSARA, 406	12	50
0501 121 111	7518.CO		BLACK COVER PLUG	C4 PICASSO, C5 1+2, C6, SAXO, XSARA 1+2, XSARA PICASSO 1+2, C25, BERLINGO 1+2, 407, PARTNER 1+2, J5	13	25
0501 121 112	9614248780		BLACK SPECIAL CABLE TIE	-	16	50
0501 121 113	9616667880		SPECIAL CABLE TIE PA 66 BK	-	17	25
0501 121 114	9605351680		CABLE TIE PA 66 3.0 - 40.0 MM FOR BOLTS OR SCREWS	-	18	25
0501 121 115	9623883980		ROD RETAINER DIA. 7.5 - 7.8 MM PA 6 BLACK	-	15	25
0501 121 116	9628305780		PLASTIC CABLE CLAMP PA 6 BLACK	-	20	25
0501 121 117	9642874480		PLASTIC SPLIT RIVET PA 6 BLACK	C2, C3, C4, C5, C6, C8, XSARA II, 1007, 207, 407, 807, EXPERT, JUMPY	22	50
0501 121 117	6991.X7		PLASTIC SPLIT RIVET PA 6 BLACK	C2, C3, C4, C5, C6, C8, XSARA II, 1007, 207, 407, 807, EXPERT, JUMPY	22	50
0501 121 118	9608351380	6539ASSH	BLACK PLASTIC SPLIT RIVET POM 902 BLACK 4.0 - 4.2 MM	XSARA, 206, 306, 406	25	100
0501 121 118	6972.24	6539ASSH	BLACK PLASTIC SPLIT RIVET POM 902 BLACK 4.0 - 4.2 MM	XSARA, 206, 306, 406	25	100
0501 121 120	Z000327504		PLASTIC SPLIT RIVET POM BK	-	27	25
0501 121 121	6997.83		PLASTIC SPLIT RIVET BK	206, 306, C4	29	25

Index sorted by Art. No.						
Art. No.	Orig. No.	Eurocode	Designation	Car type	Fig.	P. Qty.
0501 121 122	6547.20		PLASTIC RIVET WITHOUT PIN	C4, C8, EVASION, 605 1+2, PARTNER 1+2, AX, ZX, XM 1+2, C5 1+2, BERLINGO 2, C15, PICASSO	32	100
0501 121 123	9629041880		EXPANDING NUT PA 661 COLORLESS	-	33	100
0501 121 124			BLACK EXPANDING NUT	308	35	50
0501 121 125	6992.80		COLORLESS EXPANDING NUT	607, 806 PHASE 2, 807, 206 CC, 205, 309, 405, 605, ZX, XANTIA	36	100
0501 121 126	6995.N7		COLORLESS GROMMET	AX, SAXO, BX, XSARA, PICASSO, XANTIA, XM, EVASION	38	100
0501 121 127	8565.17		BLACK GROMMET	AX, ZX, BX, XM, XSARA, XANTIA, EVASION, PICASSO, BERLINGO, 106, 306, 309, 405	39	100
0501 121 128	6992.82		COLORLESS INTERIOR LINING CLIP + SEALING WASHER BK	205, 309, 806, EVASION, EXPERT, JUMPY	43	50
0501 121 129	6990.50		COLORLESS INTERIOR LINING CLIP	205, 309, 806, SAXO, XSARA, XANTIA, BERLINGO, PICASSO, 406, PARTNER	44	50
0501 121 130	6991.S6	2730ASCTS1B	INTERIOR LINING CLIP PA CLR.	106 PHASE II, 405, 406, 806 PH2, 206, 207, 307, 407, 607, C2, C3, C4, C5, XSARA II	45	50
0501 121 131	6991.87		COLORLESS INTERIOR LINING CLIP	205, 405 PHASE 2, 605, 806	46	50
0501 121 132	6991.Y8		INTERIOR LINING CLIP POM COLORLESS	C3, C8, 207, 407, 807, BERLINGO, PARTNER	47	25
0501 121 133	6991.E8		COLORLESS INTERIOR LINING CLIP	206, 306 PHASE 2	48	50
0501 121 134	8565.40	6545ASCTB 6539ASCHB	COLORLESS INTERIOR LINING CLIP	SAXO, C2, EVASION, 206, 1007, 207, 306, 307, 806, 807, BERLINGO, EXPERT	49	25
0501 121 135	6995.X3		INTERIOR LINING CLIP CLR.	206, 306	50	100
0501 121 136	8565.34		BLACK INTERIOR LINING CLIP	406 PHASE 2	51	50
0501 121 137	8565.35		BLACK INTERIOR LINING CLIP	SAXO, XSARA, XANTIA, C5, PICASSO, BERLINGO, 206, 407, PARTNER	52	100
0501 121 138	6974.04		SCREW M6x20 10 MM DACROMET SILVER	-	58	100
0501 121 139	9613079480		THREADED BLIND RIVET PA 664 BLACK	-	60	25
0501 121 140	9699542280		THREADED BLIND RIVET POM BLACK	UNIVERSAL	61	100
0501 121 140	6555.LE		THREADED BLIND RIVET POM BLACK	UNIVERSAL	61	100
0501 121 141	9630090980		THREADED BLIND RIVET WITH TORX DIA. 5.8 - 10.0 MM POM/PA 6 BLACK	C3, C4, C5, C8, 307, 607, 807	62	25
0501 121 142	7030.16		TURN-LOCK FASTENER GEOMET SILVER	207, 807, BERLINGO, EXPERT, PARTNER	71	50
0501 121 142	9632676980		TURN-LOCK FASTENER GEOMET SILVER	207, 807, BERLINGO, EXPERT, PARTNER	71	50
0501 121 143	7013.J0		RECURSION RIVET PA 66 BLACK	307, 607, 807, C3, C4, C5, C8, C15	72	25
0501 121 144	9621997380		SPECIAL FASTENER PA 607 BLACK	-	74	25
0501 121 145	7030.18		CLIP FOR TURN-LOCK FASTENER D063 GEOMET	BERLINGO, EXPERT, PARTNER, 807	75	100
0501 121 145	9632677180		CLIP FOR TURN-LOCK FASTENER D063 GEOMET	BERLINGO, EXPERT, PARTNER, 807	75	100

Index sorted by Art. No.						
Art. No.	Orig. No.	Eurocode	Designation	Car type	Fig.	P. Qty.
0501 121 146	8565.48		WHITE TRIM CLIP	C4, EXPERT, JUMPY	57	25
0501 121 190	9648975680		BLACK PLASTIC SPLIT RIVET PA66	206, 207, 307, 308, 407, 607, 1007, EXPERT, PARTNER, RANCH	30	50
0501 121 190	8565.53		BLACK PLASTIC SPLIT RIVET PA66	206, 207, 307, 308, 407, 607, 1007, EXPERT, PARTNER, RANCH	30	50
0501 121 191	6973.24		PLASTIC SPLIT RIVET PA66	309, 605	31	10
0501 121 191	6973.34		PLASTIC SPLIT RIVET PA66	309, 605	31	10
0501 121 192	8123.96	2735ASCMS	INTERIOR LINING CLIP POM COLORLESS + SEALING WASHER BK	-	54	10
0501 167 008	7518.N8		COVER PLUG FOR COARSE THREAD PP BLACK	UNIVERSAL	4	50
0501 167 018	6991.54		BLACK GROMMET	AX, BX, PICASSO, 106, 205 GTI, 306, 309, 405, 806	40	100
0501 167 059	6987.A7		EXPANDING NUT PA 6 COLORLESS	UNIVERSAL	34	25
0501 321 002	8110.24	6547ASCHS	COLORLESS INTERIOR LINING CLIP WITH SEALING WASHER	1007 AB 05	53	25
0501 321 003	6995.S0	2725ASCHB	INTERIOR LINING CLIP POM BLACK	XSARA, EXPERT 1+2, 806	55	25
0501 321 004	8123.89	6544ASCSS	COLORLESS WINDOW CLIP POM	407, 308	67	25
0501 321 005	8123.91	6544ASCSS2B	COLORLESS WINDOW CLIP POM	407	68	25
0501 321 006	8123.90	6544ASCSS1B	GRAY WINDOW CLIP POM	407	66	25
0501 321 007	8123.88	2731ASCHS	COLORLESS WINDOW CLIP POM	C2	70	25
0501 321 008	8123.64	6525ASCS	SPACER PA 12 BLACK	-	63	25
0501 321 009	96060797		BLACK SPACER	BERLINGO 97/XSARA PICASSO 00, ZX, PARTNER, XANTIA 93	65	25
0501 321 010	8123.98		WINDOW CLIP POM YELLOW	C5 III	69	25
0501 321 011	8123.65	6525ASCSS	BLACK RETAINING CLIP	406	73	25
0501 321 012	8520.80	6520ASCH	SPACER PP BLACK	106	64	25

Index sorted by Orig. No.						
Orig. No.	Art. No.	Eurocode	Designation	Car type	Fig.	P. Qty.
	0501 121 124		BLACK EXPANDING NUT	308	35	50
5405.55	0362 121 25		WHEEL BOLT GEOMET SILVER M12X1.25X17 19 MM *	-	59	50
6547.20	0501 121 122		PLASTIC RIVET WITHOUT PIN	C4, C8, EVASION, 605 1+2, PARTNER 1+2, AX, ZX, XM 1+2, C5 1+2, BERLINGO 2, C15, PICASSO	32	100
697202	0500 718		PLASTIC SPLIT RIVET PA 66 BLACK	206, AX, BERLINGO	28	25
6973.24	0501 121 191		PLASTIC SPLIT RIVET PA66	309, 605	31	10
6973.34	0501 121 191		PLASTIC SPLIT RIVET PA66	309, 605	31	10
6974.04	0501 121 138		SCREW M6x20 10 MM DACROMET SILVER	-	58	100
6983.05	0501 121 105		COVER PLUG PE LD BLACK	SAXO 1+2, XSARA 1+2, XSARA PICASSO, BERLINGO 1+2, 106 1+2, 205, 206, 207, 307 1+2, 308, 309, 405, 406 1+2, 206CC, PARTNER 1+2, BX, C4, C4 PICASSO, C15	7	100
7568.HO	0501 121 105		COVER PLUG PE LD BLACK	SAXO 1+2, XSARA 1+2, XSARA PICASSO, BERLINGO 1+2, 106 1+2, 205, 206, 207, 307 1+2, 308, 309, 405, 406 1+2, 206CC, PARTNER 1+2, BX, C4, C4 PICASSO, C15	7	100
96183626XT	0501 121 105		COVER PLUG PE LD BLACK	SAXO 1+2, XSARA 1+2, XSARA PICASSO, BERLINGO 1+2, 106 1+2, 205, 206, 207, 307 1+2, 308, 309, 405, 406 1+2, 206CC, PARTNER 1+2, BX, C4, C4 PICASSO, C15	7	100
6983.17	0501 121 106		BLACK COVER PLUG PE-LD	106, 205, 206, 405, 406, 605, AX, SAXO, C15	8	25
8964.77	0501 121 106		BLACK COVER PLUG PE-LD	106, 205, 206, 405, 406, 605, AX, SAXO, C15	8	25
6987.A7	0501 167 059		EXPANDING NUT PA 6 COLORLESS	UNIVERSAL	34	25
6990.50	0501 121 129		COLORLESS INTERIOR LINING CLIP	205, 309, 806, SAXO, XSARA, XANTIA, BERLINGO, PICASSO, 406, PARTNER	44	50
6991.54	0501 167 018		BLACK GROMMET	AX, BX, PICASSO, 106, 205 GTI, 306, 309, 405, 806	40	100
6991.87	0501 121 131		COLORLESS INTERIOR LINING CLIP	205, 405 PHASE 2, 605, 806	46	50
6991.E8	0501 121 133		COLORLESS INTERIOR LINING CLIP	206, 306 PHASE 2	48	50
6991.S6	0501 121 130	2730ASCTS1B	INTERIOR LINING CLIP PA CLR.	106 PHASE II, 405, 406, 806 PH2, 206, 207, 307, 407, 607, C2, C3, C4, C5, XSARA II	45	50
6991.Y8	0501 121 132		INTERIOR LINING CLIP POM COLORLESS	C3, C8, 207, 407, 807, BERLINGO, PARTNER	47	25
6992.80	0501 121 125		COLORLESS EXPANDING NUT	607, 806 PHASE 2, 807, 206 CC, 205, 309, 405, 605, ZX, XANTIA	36	100
6992.82	0501 121 128		COLORLESS INTERIOR LINING CLIP + SEALING WASHER BK	205, 309, 806, EVASION, EXPERT, JUMPY	43	50

Index sorted by Orig. No.						
Orig. No.	Art. No.	Eurocode	Designation	Car type	Fig.	P. Qty.
6992.95	0501 121 107		BLACK COVER PLUG	UNIVERSAL, 106, 306, 405, 605, 806	9	50
6999.R2	0501 121 107		BLACK COVER PLUG	UNIVERSAL, 106, 306, 405, 605, 806	9	50
6992.C6	0501 121 109		COVER PLUG PA 66 BLACK	AX, XANTIA 1+2, C15, 106, 306 PHASE 1+2, 607 1+2, PARTNER, 206, 307 PHASE 2, 309, 406 1+2, 605 PHASE 2, SAXO, ZX, XSARA 1+2, XSARA PICASSO 1+2, C4, XM 1+2, BERLINGO PHASE 2	11	50
6992.K8	0501 121 108		BLACK COVER PLUG	SAXO, XSARA, XANTIA, BERLINGO, EVASION	10	25
6999.A3	0501 121 108		BLACK COVER PLUG	SAXO, XSARA, XANTIA, BERLINGO, EVASION	10	25
6995.02	0500 671		COLORLESS INTERIOR LINING CLIP	BX, 205, 309, 806, AX, ZX, XANTIA, XM, EVASION	56	25
7903077112	0500 671		COLORLESS INTERIOR LINING CLIP	BX, 205, 309, 806, AX, ZX, XANTIA, XM, EVASION	56	25
6995.15	0500 682 9		FIR-TREE CLIP PA 66 BLACK	ZX, SAXO, 106, 306 PHASE 2	2	50
6995.A3	0500 680 8		INTERIOR LINING CLIP FOR RENAULT/CITROËN	106, 205, 306, 309, 405, 406, 605, 806, AX, BX, C15, EVASION	42	25
6995.N7	0501 121 126		COLORLESS GROMMET	AX, SAXO, BX, XSARA, PICASSO, XANTIA, XM, EVASION	38	100
6995.S0	0501 321 003	2725ASCHB	INTERIOR LINING CLIP POM BLACK	XSARA, EXPERT 1+2, 806	55	25
6995.V6	0501 121 104		COVER PLUG BLACK PA 6.6	C2, C5, BERLINGO, SAXO, XSARA II, XSARA PICASSO, 1007, 206, 207, PARTNER, RANCH	6	50
6995.X3	0501 121 135		INTERIOR LINING CLIP CLR.	206, 306	50	100
6997.83	0501 121 121		PLASTIC SPLIT RIVET BK	206, 306, C4	29	25
6997.86	0501 121 110		BLACK COVER PLUG	PICASSO, C8, 206, 307, 306, 807, C4, BERLINGO, SAXO, XANTIA, XSARA, 406	12	50
6999.T1	0500 680 3		COVER PLUG RENAULT/CITROËN POM BLACK	UNIVERSAL	3	50
7013.J0	0501 121 143		RECURSION RIVET PA 66 BLACK	307, 607, 807, C3, C4, C5, C8, C15	72	25
7030.16	0501 121 142		TURN-LOCK FASTENER GEOMET SILVER	207, 807, BERLINGO, EXPERT, PARTNER	71	50
9632676980	0501 121 142		TURN-LOCK FASTENER GEOMET SILVER	207, 807, BERLINGO, EXPERT, PARTNER	71	50
7030.18	0501 121 145		CLIP FOR TURN-LOCK FASTENER D063 GEOMET	BERLINGO, EXPERT, PARTNER, 807	75	100
9632677180	0501 121 145		CLIP FOR TURN-LOCK FASTENER D063 GEOMET	BERLINGO, EXPERT, PARTNER, 807	75	100
7518.CO	0501 121 111		BLACK COVER PLUG	C4 PICASSO, C5 1+2, C6, SAXO, XSARA 1+2, XSARA PICASSO 1+2, C25, BERLINGO 1+2, 407, PARTNER 1+2, J5	13	25

Index sorted by Orig. No.						
Orig. No.	Art. No.	Eurocode	Designation	Car type	Fig.	P. Qty.
7518.N8	0501 167 008		COVER PLUG FOR COARSE THREAD PP BLACK	UNIVERSAL	4	50
7813.24	0500 40	6539ASSHB	PLASTIC SPLIT RIVET FOR LUGGAGE COMPARTMENT LINING PA 6 BLACK	206, 306, 406, XSARA	24	50
7903072116	0500 124 28		PLASTIC SPLIT RIVET PA 122 BLACK *	-	23	50
7903072170	0500 523 14		PLASTIC SPLIT RIVET PA12 BLACK	205	21	50
7903079004	0500 531 64		PLASTIC CABLE CLAMP 9.5 MM PA 6 GRAY	-	19	25
8110.24	0501 321 002	6547ASCHS	COLORLESS INTERIOR LINING CLIP WITH SEALING WASHER	1007 AB 05	53	25
8123.64	0501 321 008	6525ASCS	SPACER PA 12 BLACK	-	63	25
8123.65	0501 321 011	6525ASCSS	BLACK RETAINING CLIP	406	73	25
8123.88	0501 321 007	2731ASCHS	COLORLESS WINDOW CLIP POM	C2	70	25
8123.89	0501 321 004	6544ASCSS	COLORLESS WINDOW CLIP POM	407, 308	67	25
8123.90	0501 321 006	6544ASCSS1B	GRAY WINDOW CLIP POM	407	66	25
8123.91	0501 321 005	6544ASCSS2B	COLORLESS WINDOW CLIP POM	407	68	25
8123.96	0501 121 192	2735ASCMS	INTERIOR LINING CLIP POM COLORLESS + SEALING WASHER BK	-	54	10
8123.98	0501 321 010		WINDOW CLIP POM YELLOW	C5 III	69	25
8326.N4	0501 121 103		BLACK COVER PLUG	205 GTI, 806, AX, SAXO, BX, XSARA, PICASSO, XANTIA, XM	5	50
7903077167	0501 121 103		BLACK COVER PLUG	205 GTI, 806, AX, SAXO, BX, XSARA, PICASSO, XANTIA, XM	5	50
8520.80	0501 321 012	6520ASCH	SPACER PP BLACK	106	64	25
8565.17	0501 121 127		BLACK GROMMET	AX, ZX, BX, XM, XSARA, XANTIA, EVASION, PICASSO, BERLINGO, 106, 306, 309, 405	39	100
8565.34	0501 121 136		BLACK INTERIOR LINING CLIP	406 PHASE 2	51	50
8565.35	0501 121 137		BLACK INTERIOR LINING CLIP	SAXO, XSARA, XANTIA, C5, PICASSO, BERLINGO, 206, 407, PARTNER	52	100
8565.40	0501 121 134	6545ASCTB 6539ASCHB	COLORLESS INTERIOR LINING CLIP	SAXO, C2, EVASION, 206, 1007, 207, 306, 307, 806, 807, BERLINGO, EXPERT	49	25
8565.48	0501 121 146		WHITE TRIM CLIP	C4, EXPERT, JUMPY	57	25
8964.57	0500 939 5		BLACK FIR-TREE CLIP	PICASSO, BERLINGO 1+2, 106 1+2, 205, 206, 306, 307 1+2, 405, 605 1+2, PARTNER 1+2	1	50
9605351680	0501 121 114		CABLE TIE PA 66 3.0 - 40.0 MM FOR BOLTS OR SCREWS	-	18	25
96060797	0501 321 009		BLACK SPACER	BERLINGO 97/XSARA PICASSO 00, ZX, PARTNER, XANTIA 93	65	25

Index sorted by Orig. No.						
Orig. No.	Art. No.	Eurocode	Designation	Car type	Fig.	P. Qty.
9608351380	0501 121 118	6539ASSH	BLACK PLASTIC SPLIT RIVET POM 902 BLACK 4.0 - 4.2 MM	XSARA, 206, 306, 406	25	100
6972.24	0501 121 118	6539ASSH	BLACK PLASTIC SPLIT RIVET POM 902 BLACK 4.0 - 4.2 MM	XSARA, 206, 306, 406	25	100
9613079480	0501 121 139		THREADED BLIND RIVET PA 664 BLACK	-	60	25
9614248780	0501 121 112		BLACK SPECIAL CABLE TIE	-	16	50
9616667880	0501 121 113		SPECIAL CABLE TIE PA 66 BK	-	17	25
9616796	0500 515 10		U-CLIP GALV. CLR. PASSIV.	-	41	25
9621997380	0501 121 144		SPECIAL FASTENER PA 607 BLACK	-	74	25
9623883980	0501 121 115		ROD RETAINER DIA. 7.5 - 7.8 MM PA 6 BLACK	-	15	25
9628305780	0501 121 116		PLASTIC CABLE CLAMP PA 6 BLACK	-	20	25
9629041880	0501 121 123		EXPANDING NUT PA 661 COLORLESS	-	33	100
9629547080	0500 117 07		GROMMET FOR LETTERING PE 181 CLR.	205	37	100
9630090980	0501 121 141		THREADED BLIND RIVET WITH TORX DIA. 5.8 - 10.0 MM POM/PA 6 BLACK	C3, C4, C5, C8, 307, 607, 807	62	25
9640855880	0501 105 117		PLASTIC SPLIT RIVET PA 66 BK	-	26	100
9642874480	0501 121 117		PLASTIC SPLIT RIVET PA 6 BLACK	C2, C3, C4, C5, C6, C8, XSARA II, 1007, 207, 407, 807, EXPERT, JUMPY	22	50
6991.X7	0501 121 117		PLASTIC SPLIT RIVET PA 6 BLACK	C2, C3, C4, C5, C6, C8, XSARA II, 1007, 207, 407, 807, EXPERT, JUMPY	22	50
9648975680	0501 121 190		BLACK PLASTIC SPLIT RIVET PA66	206, 207, 307, 308, 407, 607, 1007, EXPERT, PARTNER, RANCH	30	50
8565.53	0501 121 190		BLACK PLASTIC SPLIT RIVET PA66	206, 207, 307, 308, 407, 607, 1007, EXPERT, PARTNER, RANCH	30	50
9699542280	0501 121 140		THREADED BLIND RIVET POM BLACK	UNIVERSAL	61	100
6555.LE	0501 121 140		THREADED BLIND RIVET POM BLACK	UNIVERSAL	61	100
9699583680	0501 102 001		ROD RETAINER DIA. 7.0 - 21.0 MM POM BLACK	-	14	25
Z000327504	0501 121 120		PLASTIC SPLIT RIVET POM BK	-	27	25

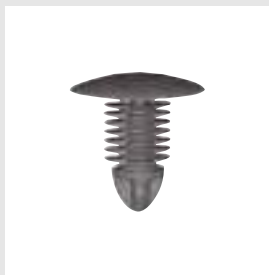

Art. No. 0501 132 010
 Orig. No.: 01553-00732
 Fig. No.: 1



Art. No. 0501 132 011
 Orig. No.: 90909-E4100
 Fig. No.: 2



Art. No. 0500 788 002
 Orig. No.: 01553-00051
 Fig. No.: 3

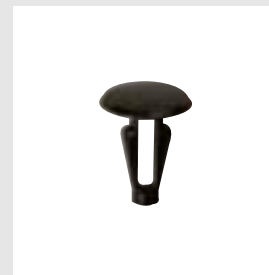

Art. No. 0500 788 001
 Orig. No.: 01553-00172
 Fig. No.: 4

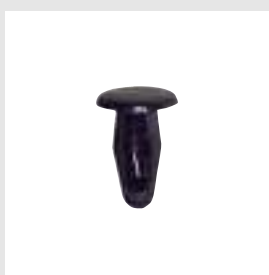

Art. No. 0500 788 028
 Orig. No.: 01553-00291
 Fig. No.: 5

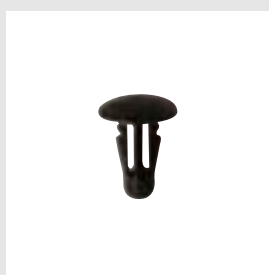

Art. No. 0500 788 033
 Orig. No.: 01553-00401
 Fig. No.: 6

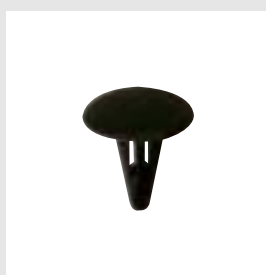

Art. No. 0500 788 035
 Orig. No.: 27948-M7002
 Fig. No.: 7



Art. No. 0500 788 018
 Orig. No.:
 Fig. No.: 8



Art. No. 0500 788 027
 Orig. No.: 96706-K1300
 Fig. No.: 9



Art. No. 0500 788 037
 Orig. No.: 01281-00022
 Fig. No.: 10



Art. No. 0500 788 038
 Orig. No.: 67898-U0100
 Fig. No.: 11



Art. No. 0500 788 026
 Orig. No.: 01281-00231
 96706-U0100
 Fig. No.: 12



Art. No. 0501 132 012
 Orig. No.: 01553-02923
 Fig. No.: 13



Art. No. 0501 132 001
 Orig. No.: 01553-09131
 Fig. No.: 14



Art. No. 0501 132 013
 Orig. No.: 66820-9F900
 Fig. No.: 15



Art. No. 0501 132 002
 Orig. No.: 63854-01A00
 Fig. No.: 16



Art. No. 0501 167 028
Orig. No.: 01515-00QAB
Fig. No.: 17



Art. No. 0501 132 003
Orig. No.: 01553-09321
Fig. No.: 18



Art. No. 0501 132 004
Orig. No.: 01553-09611
Fig. No.: 19

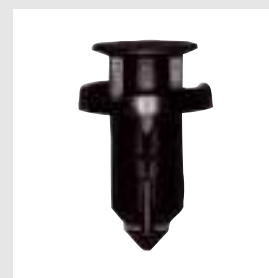

Art. No. 0501 132 005
Orig. No.: 01553-09241
Fig. No.: 20

Index sorted by Art. No.						
Art. No.	Orig. No.	Eurocode	Designation	Car type	Fig.	P. Qty.
0500 788 001	01553-00172		BLACK PLASTIC RIVET WITHOUT PIN *	-	4	25
0500 788 002	01553-00051		BLACK PLASTIC RIVET WITHOUT PIN *	VARIOUS MODELS	3	25
0500 788 018			COLORLESS EXPANDING NUT FOR DATSUN/MAZDA*	-	8	25
0500 788 026	01281-00231		EXPANDING NUT DATSUN/TOYOTA/MITSUB*	MICRA, SUNNY	12	25
0500 788 026	96706-U0100		EXPANDING NUT DATSUN/TOYOTA/MITSUB*	MICRA, SUNNY	12	25
0500 788 027	96706-K1300		COLORLESS EXPANDING NUT DATSUN*	-	9	25
0500 788 028	01553-00291		PLASTIC RIVET PA 6 BLACK DATSUN/MAZDA*	-	5	25
0500 788 033	01553-00401		BLACK PLASTIC RIVET WITHOUT PIN DATSUN*	-	6	25
0500 788 035	27948-M7002		BLACK PLASTIC RIVET WITHOUT PIN DATSUN*	-	7	25
0500 788 037	01281-00022		EXPANDING NUT PA 6 COLORLESS DATSUN*	-	10	25
0500 788 038	67898-U0100		COLORLESS EXPANDING NUT DATSUN*	-	11	25
0501 132 001	01553-09131		BLUE INTERIOR LINING CLIP*	-	14	25
0501 132 002	63854-01A00		BLACK SPLIT RIVET*	MICRA, PRIMERA, SUNNY	16	25
0501 132 003	01553-09321		BLACK PLASTIC SPLIT RIVET*	X-TRAIL	18	25
0501 132 004	01553-09611		BLACK PLASTIC SPLIT RIVET*	-	19	25
0501 132 005	01553-09241		BLACK PLASTIC SPLIT RIVET*	VARIOUS MODELS	20	25
0501 132 010	01553-00732		COVER PLUG PA GRAY *	-	1	50
0501 132 011	90909-E4100		BLACK PLASTIC SPLIT RIVET*	-	2	10
0501 132 012	01553-02923		GROMMET POM COLORLESS WITH FOAM SEAL BLACK*	TERRANO II AB 96	13	10
0501 132 013	66820-9F900		INTERIOR LINING CLIP PA COLORLESS*	PRIMERA	15	10
0501 167 028	01515-00QAB		BLACK RECURSION RIVET WITH SLOT	MICRA	17	25

Index sorted by Orig. No.						
Orig. No.	Art. No.	Eurocode	Designation	Car type	Fig.	P. Qty.
	0500 788 018		COLORLESS EXPANDING NUT FOR DATSUN/MAZDA*	-	8	25
01281-00022	0500 788 037		EXPANDING NUT PA 6 COLORLESS DATSUN*	-	10	25
01281-00231	0500 788 026		EXPANDING NUT DATSUN/TOYOTA/MITSUB*	MICRA, SUNNY	12	25
96706-U0100	0500 788 026		EXPANDING NUT DATSUN/TOYOTA/MITSUB*	MICRA, SUNNY	12	25
01515-00QAB	0501 167 028		BLACK RECURSION RIVET WITH SLOT	MICRA	17	25
01553-00051	0500 788 002		BLACK PLASTIC RIVET WITHOUT PIN *	VARIOUS MODELS	3	25
01553-00172	0500 788 001		BLACK PLASTIC RIVET WITHOUT PIN *	-	4	25
01553-00291	0500 788 028		PLASTIC RIVET PA 6 BLACK DATSUN/MAZDA*	-	5	25
01553-00401	0500 788 033		BLACK PLASTIC RIVET WITHOUT PIN DATSUN*	-	6	25
01553-00732	0501 132 010		COVER PLUG PA GRAY *	-	1	50
01553-02923	0501 132 012		GROMMET POM COLORLESS WITH FOAM SEAL BLACK*	TERRANO II AB 96	13	10
01553-09131	0501 132 001		BLUE INTERIOR LINING CLIP*	-	14	25
01553-09241	0501 132 005		BLACK PLASTIC SPLIT RIVET*	VARIOUS MODELS	20	25
01553-09321	0501 132 003		BLACK PLASTIC SPLIT RIVET*	X-TRAIL	18	25
01553-09611	0501 132 004		BLACK PLASTIC SPLIT RIVET*	-	19	25
27948-M7002	0500 788 035		BLACK PLASTIC RIVET WITHOUT PIN DATSUN*	-	7	25
63854-01A00	0501 132 002		BLACK SPLIT RIVET*	MICRA, PRIMERA, SUNNY	16	25
66820-9F900	0501 132 013		INTERIOR LINING CLIP PA COLORLESS*	PRIMERA	15	10
67898-U0100	0500 788 038		COLORLESS EXPANDING NUT DATSUN*	-	11	25
90909-E4100	0501 132 011		BLACK PLASTIC SPLIT RIVET*	-	2	10
96706-K1300	0500 788 027		COLORLESS EXPANDING NUT DATSUN*	-	9	25

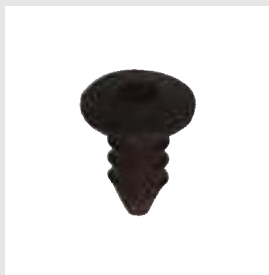

Art. No. 0501 106 201
 Orig. No.: 4227711
 Fig. No.: 1

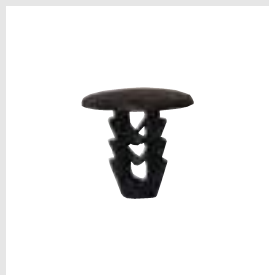

Art. No. 0501 106 149
 Orig. No.: 14591687
 Fig. No.: 2

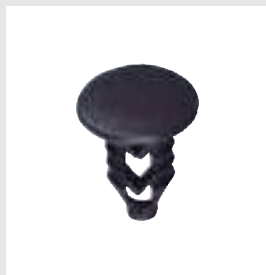

Art. No. 0500 025 205
 Orig. No.: 4292906
 Fig. No.: 3

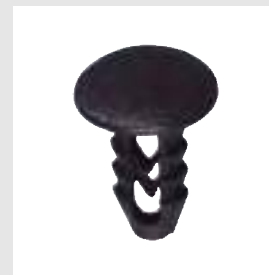

Art. No. 0500 025 206
 Orig. No.: 4274360
 Fig. No.: 4



Art. No. 0500 133 47
 Orig. No.: 14592187
 Fig. No.: 5

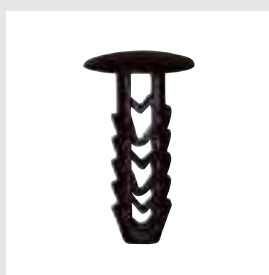

Art. No. 0500 025 459
 Orig. No.: 14592389
 Fig. No.: 6



Art. No. 0500 132 03
 Orig. No.: 14568887
 Fig. No.: 7

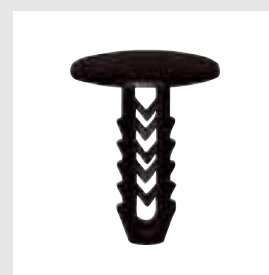

Art. No. 0500 011 58
 Orig. No.: 14591887
 Fig. No.: 8

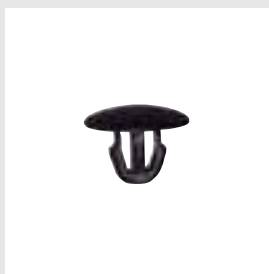

Art. No. 0501 106 203
 Orig. No.: 7768047
 Fig. No.: 9



Art. No. 0501 106 066
 Orig. No.: 712113631
 Fig. No.: 10



Art. No. 0501 106 150
 Orig. No.: 46842097
 Fig. No.: 11

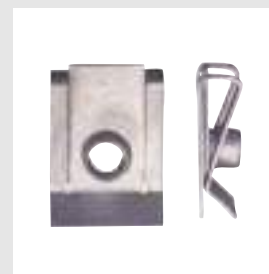

Art. No. 0501 106 075
 Orig. No.: 60811807
 Fig. No.: 12



Art. No. 0501 106 061
 Orig. No.: 60808479
 Fig. No.: 13



Art. No. 0501 106 135
 Orig. No.: 46797277
 Fig. No.: 14



Art. No. 0500 531 64
 Orig. No.: 14569680
 Fig. No.: 15

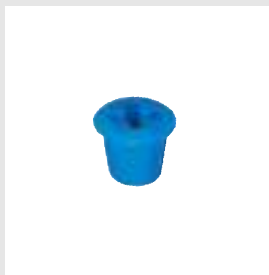

Art. No. 0500 134 390
 Orig. No.: 4358789
 Fig. No.: 16



Art. No. 0501 106 204
 Orig. No.: 77544387
 Fig. No.: 17



Art. No. 0500 134 54
 Orig. No.: 14201980
 4407294
 Fig. No.: 18



Art. No. 0501 106 069
 Orig. No.: 46408953
 Fig. No.: 19



Art. No. 0501 106 136
 Orig. No.: 7745194
 Fig. No.: 20



Art. No. 0500 117 07
 Orig. No.: 4234280
 Fig. No.: 21

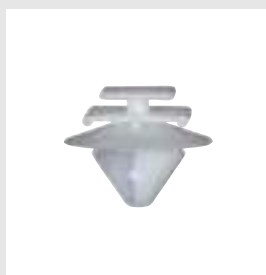

Art. No. 0501 121 134
 Orig. No.: 0071737918
 Eurocode: 6545ASCTB
 6539ASCHB
 Fig. No.: 22

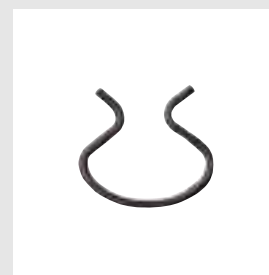

Art. No. 0501 106 095
 Orig. No.: 4138439
 Fig. No.: 23



Art. No. 0501 106 137
 Orig. No.: 7696197
 Fig. No.: 24

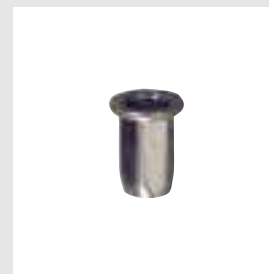

Art. No. 0501 106 079
 Orig. No.: 15624311
 Fig. No.: 25



Art. No. 0501 106 138
 Orig. No.: 15624411
 Fig. No.: 26



Art. No. 0501 129 003
 Orig. No.: 71741883
 Fig. No.: 27

Index sorted by Art. No.						
Art. No.	Orig. No.	Eurocode	Designation	Car type	Fig.	P. Qty.
0500 011 58	14591887		BLACK FIR-TREE CLIP	UNIVERSAL	8	25
0500 025 205	4292906		FIR-TREE CLIP PA 6 BLACK	UNIVERSAL	3	50
0500 025 206	4274360		FIR-TREE CLIP PA 66 BLACK	-	4	50
0500 025 459	14592389		BLACK FIR-TREE CLIP	-	6	50
0500 117 07	4234280		GROMMET FOR LETTERING PE 181 CLR.	-	21	100
0500 132 03	14568887		FIR-TREE CLIP PA 66 BLACK	DELTA 93	7	25
0500 133 47	14592187		FIR-TREE CLIP PA 6 BLACK	155, 156, GT, GTV, BRAVO, DUCATO, MAREA, PUNTO, PUNTO 99 - 03, SIENA, TALENTO, TIPO, NUOVA DELTA, THESIS	5	25
0500 134 390	4358789		EXPANDING NUT FOR ROUND HOLES PA 6 BLUE	FIORINO 93	16	25
0500 134 54	14201980		COLORLESS EXPANDING NUT	PUNTO 97 IE	18	50
0500 134 54	4407294		COLORLESS EXPANDING NUT	PUNTO 97 IE	18	50
0500 531 64	14569680		PLASTIC CABLE CLAMP 9.5 MM PA 6 GRAY	UNIVERSAL	15	25
0501 106 061	60808479		SHEET-METAL NUT M 6 GALV. CLR. PASSIV.	PUNTO 97 IE	13	50
0501 106 066	712113631		FIR-TREE CLIP PA 6 GRAY	BRAVA 1.4/1.6	10	50
0501 106 069	46408953		COLORLESS EXPANDING NUT WITH SEAL	PUNTO 97 IE	19	50
0501 106 075	60811807		SHEET-METAL NUT M 5 MET. CORR. PROT. 3.0 SI	BRAVO 1.4/1.6	12	50
0501 106 079	15624311		RIVET NUT GALV.	PUNTO CONV. 97	25	25
0501 106 095	4138439		METAL CLIP LOCK FOR WINDOW CRANK OILED	PUNTO 97 IE	23	100
0501 106 135	46797277		2X BRAKE LINE HOLDER BLACK	-	14	25
0501 106 136	7745194		EXPANDING NUT PA 6 YELLOW	BARCETTA, MULTIPLA, PALIO, PUNTO, PUNTO 99 - 03, PUNTO 03, SEICENTO, STILO, STRADA, KAPPA, LYBRA, YPSILON	20	100
0501 106 137	7696197		PAN HEAD SCREW WITH FLANGE 9 x 96 MM 13 MM	-	24	25
0501 106 138	15624411		RIVET NUT M6 GALV. CLR.	145, 146, 147, 156, 159, 164, 166, BRERA, GTV, SPIDER, BARCETTA, BRAVA, BRAVO, CINQUECENTO, DOBLÓ, DUCATO, GRANDE PUNTO, MAREA, PALIO, PUNTO, PUNTO 99 - 03, PUNTO 03, SEICENTO, STILO, DEDRA, KAPPA, LYBRA, NUOVA DELTA, THEMA, THESIS, Y 10, YPSILON	26	100
0501 106 149	14591687		FIR-TREE CLIP PA 6 BLACK	UNIVERSAL	2	25
0501 106 150	46842097		BLACK COVER PLUG POM	-	11	25
0501 106 201	4227711		FIR-TREE CLIP PA 66 BLACK	-	1	100
0501 106 203	7768047		COVER PLUG PA 6 BLACK	PUNTO	9	100
0501 106 204	77544387		WHITE EXPANDING NUT	BRAVO	17	50
0501 121 134	0071737918	6545ASCTB 6539ASCHB	COLORLESS INTERIOR LINING CLIP	-	22	25
0501 129 003	71741883		RECURSION RIVET POM BLACK *	SEDICI	27	25

Index sorted by Orig. No.						
Orig. No.	Art. No.	Eurocode	Designation	Car type	Fig.	P. Qty.
0071737918	0501 121 134	6545ASCTB 6539ASCHB	COLORLESS INTERIOR LINING CLIP	-	22	25
14201980	0500 134 54		COLORLESS EXPANDING NUT	PUNTO 97 IE	18	50
4407294	0500 134 54		COLORLESS EXPANDING NUT	PUNTO 97 IE	18	50
14568887	0500 132 03		FIR-TREE CLIP PA 66 BLACK	DELTA 93	7	25
14569680	0500 531 64		PLASTIC CABLE CLAMP 9.5 MM PA 6 GRAY	UNIVERSAL	15	25
14591687	0501 106 149		FIR-TREE CLIP PA 6 BLACK	UNIVERSAL	2	25
14591887	0500 011 58		BLACK FIR-TREE CLIP	UNIVERSAL	8	25
14592187	0500 133 47		FIR-TREE CLIP PA 6 BLACK	155, 156, GT, GTV, BRAVO, DUCATO, MAREA, PUNTO, PUNTO 99 - 03, SIENA, TALENTO, TIPO, NUOVA DELTA, THESIS	5	25
14592389	0500 025 459		BLACK FIR-TREE CLIP	-	6	50
15624311	0501 106 079		RIVET NUT GALV.	PUNTO CONV. 97	25	25
15624411	0501 106 138		RIVET NUT M6 GALV. CLR.	145, 146, 147, 156, 159, 164, 166, BRERA, GTV, SPIDER, BARCHETTA, BRAVA, BRAVO, CINQUECENTO, DOBLÓ, DUCATO, GRANDE PUNTO, MAREA, PALIO, PUNTO, PUNTO 99 - 03, PUNTO 03, SEICENTO, STI- LO, DEDRA, KAPPA, LYBRA, NUOVA DELTA, THEMA, THESIS, Y 10, YPSILON	26	100
4138439	0501 106 095		METAL CLIP LOCK FOR WINDOW CRANK OILED	PUNTO 97 IE	23	100
4227711	0501 106 201		FIR-TREE CLIP PA 66 BLACK	-	1	100
4234280	0500 117 07		GROMMET FOR LETTERING PE 181 CLR.	-	21	100
4274360	0500 025 206		FIR-TREE CLIP PA 66 BLACK	-	4	50
4292906	0500 025 205		FIR-TREE CLIP PA 6 BLACK	UNIVERSAL	3	50
4358789	0500 134 390		EXPANDING NUT FOR ROUND HOLES PA 6 BLUE	FIORINO 93	16	25
46408953	0501 106 069		COLORLESS EXPANDING NUT WITH SEAL	PUNTO 97 IE	19	50
46797277	0501 106 135		2X BRAKE LINE HOLDER BLACK	-	14	25
46842097	0501 106 150		BLACK COVER PLUG POM	-	11	25
60808479	0501 106 061		SHEET-METAL NUT M 6 GALV. CLR. PASSIV.	PUNTO 97 IE	13	50
60811807	0501 106 075		SHEET-METAL NUT M 5 MET. CORR. PROT. 3.0 SI	BRAVO 1.4/1.6	12	50
712113631	0501 106 066		FIR-TREE CLIP PA 6 GRAY	BRAVA 1.4/1.6	10	50
71741883	0501 129 003		RECURSION RIVET POM BLACK *	SEDICI	27	25
7696197	0501 106 137		PAN HEAD SCREW WITH FLANGE 9 x 96 MM 13 MM	-	24	25
7745194	0501 106 136		EXPANDING NUT PA 6 YELLOW	BARCHETTA, MULTIPLA, PALIO, PUNTO, PUNTO 99 - 03, PUNTO 03, SEICENTO, STILO, STRADA, KAPPA, LYBRA, YPSILON	20	100
77544387	0501 106 204		WHITE EXPANDING NUT	BRAVO	17	50
7768047	0501 106 203		COVER PLUG PA 6 BLACK	PUNTO	9	100

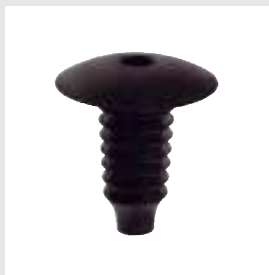

Art. No. 0501 105 601
 Orig. No.: 1079129
 6998849
 Fig. No.: 1

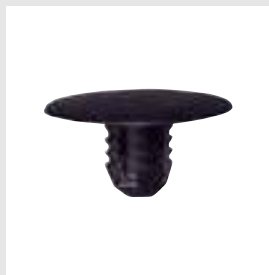

Art. No. 0501 102 021
 Orig. No.: 6678518
 Fig. No.: 2

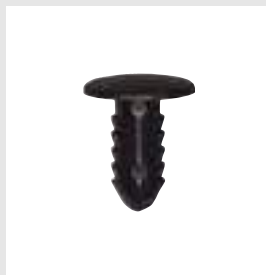

Art. No. 0500 921 9
 Orig. No.: 1489595
 Fig. No.: 3

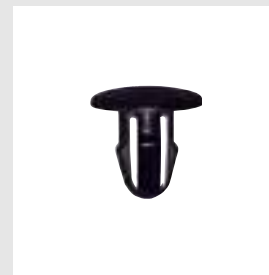

Art. No. 0500 8
 Orig. No.: 1443038
 Fig. No.: 4



Art. No. 0500 125 51
 Orig. No.: 1480335
 Fig. No.: 5



Art. No. 0501 321 001
 Orig. No.: 6049625
 Eurocode: 6537ASCV6B
 Fig. No.: 6



Art. No. 0500 940 5
 Orig. No.: 1629082
 Fig. No.: 7

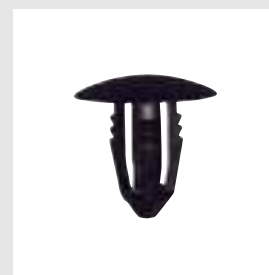

Art. No. 0500 145 45
 Orig. No.: 1629279
 6725950
 Fig. No.: 8

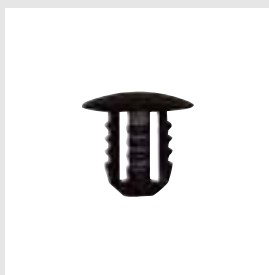

Art. No. 0501 102 022
 Orig. No.: 6786759
 Fig. No.: 9

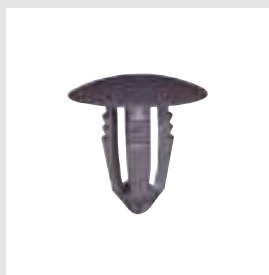

Art. No. 0501 102 023
 Orig. No.: 1018434
 Fig. No.: 10



Art. No. 0501 101 621
 Orig. No.: 1065204
 Fig. No.: 11

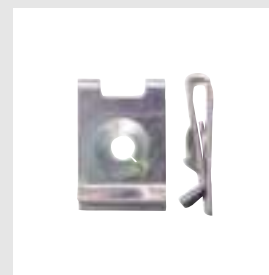

Art. No. 0500 121 9
 Orig. No.: 1474663
 Fig. No.: 12

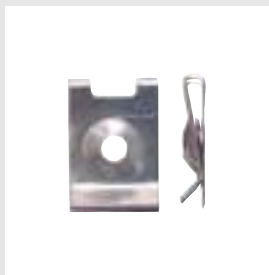

Art. No. 0500 113 46
 Orig. No.: 237929
 Fig. No.: 13

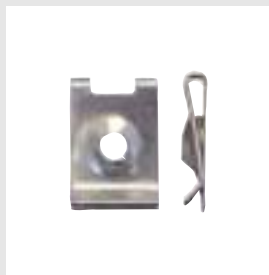

Art. No. 0500 113 62
 Orig. No.: 222026
 Fig. No.: 14

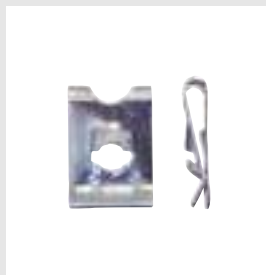

Art. No. 0500 053 6
 Orig. No.: 1716235
 Fig. No.: 15

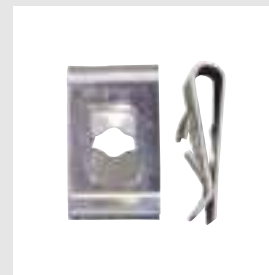

Art. No. 0500 053 7
 Orig. No.: 1450293
 0207266
 Fig. No.: 16



Art. No. 0500 113 69
 Orig. No.: 0227326
 Fig. No.: 17



Art. No. 0500 114 04
 Orig. No.: 6031840
 6738766
 Fig. No.: 18



Art. No. 0500 114 27
 Orig. No.: 1470998
 Fig. No.: 19



Art. No. 0500 408 0
 Orig. No.: 6740771
 4852244
 Fig. No.: 20



Art. No. 0501 104 120
 Orig. No.: E824115S74
 Fig. No.: 21



Art. No. 0501 102 005
 Orig. No.: 6103426
 Fig. No.: 22



Art. No. 0501 102 026
 Orig. No.: 6089805
 Fig. No.: 23



Art. No. 0500 133
 Orig. No.: 6028434
 Fig. No.: 24



Art. No. 0501 302 001
 Orig. No.: 6059465
 Eurocode: 3541ASCH
 Fig. No.: 25



Art. No. 0500 411
 Orig. No.:
 Fig. No.: 26



Art. No. 0501 101 649
 Orig. No.: 6715468
 Fig. No.: 27

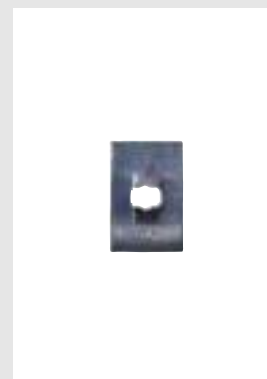

Art. No. 0501 105 113
 Orig. No.: 1503837
 Fig. No.: 28

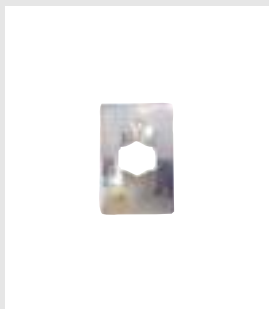

Art. No. 0500 111 82
 Orig. No.: 1507374
 Fig. No.: 29

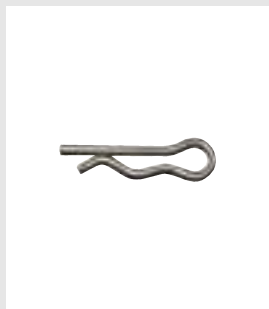

Art. No. 0500 307 71
 Orig. No.: 1473931
 Fig. No.: 30

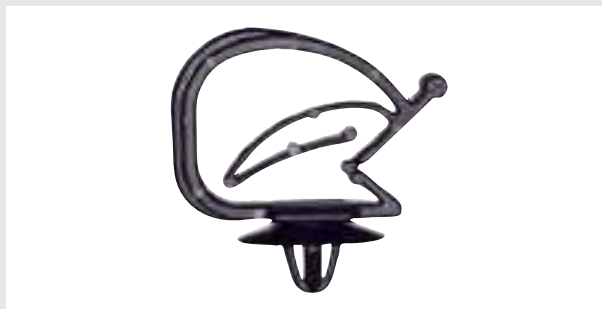

Art. No. 0501 102 001
 Orig. No.: 6105034
 Fig. No.: 31



Art. No. 0501 103 035
 Orig. No.: 1009164
 Fig. No.: 32

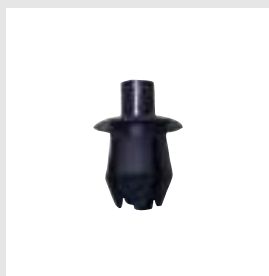

Art. No. 0500 937 7
 Orig. No.: 7200671
 Fig. No.: 33



Art. No. 0501 102 006
 Orig. No.: 1500238
 Fig. No.: 34



Art. No. 0501 102 008
 Orig. No.: 6150260
 Fig. No.: 35

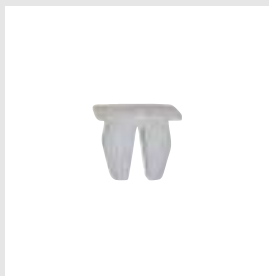

Art. No. 0501 101 631
 Orig. No.: 1416795
 Fig. No.: 36



Art. No. 0500 405 0
 Orig. No.: 6117693
 Fig. No.: 37



Art. No. 0501 102 024
 Orig. No.: 6176723
 6117693
 Fig. No.: 38



Art. No. 0501 102 009
 Orig. No.: 1257376
 Fig. No.: 39



Art. No. 0501 102 010
 Orig. No.: 1020732
 Fig. No.: 40



Art. No. 0501 101 659
 Orig. No.: 1008086
 Fig. No.: 41



Art. No. 0501 302 002
 Orig. No.: 1020193
 Eurocode: 3546ASCHB2B
 Fig. No.: 42



Art. No. 0500 116 39
 Orig. No.: 0537655
 Fig. No.: 43



Art. No. 0362 14 15
 Orig. No.: 1377748
 Fig. No.: 44



Art. No. 0362 120 15
 Orig. No.: 1470843
 Fig. No.: 45



Art. No. 0501 302 003
 Orig. No.: 6114021
 Eurocode: 3731ASCV6B
 Fig. No.: 46

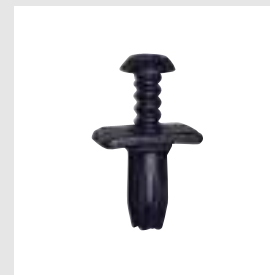

Art. No. 0500 292 9
 Orig. No.: 1629549
 Eurocode: 6743363
 Fig. No.: 47



Art. No. 0501 302 004
 Orig. No.: 4069907
 Eurocode: 4494056
 Eurocode: 3739ASCVS
 Fig. No.: 48

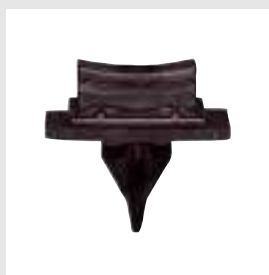

Art. No. 0501 302 005
 Orig. No.: 4069906
 Eurocode: 4494055
 Eurocode: 3739ASCVS1B
 Fig. No.: 49

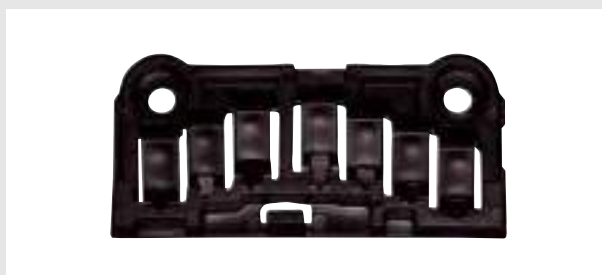

Art. No. 0501 102 025
 Orig. No.: 1022510
 Eurocode: 3546ASCHB1B
 Fig. No.: 50



Art. No. 0501 102 012
 Orig. No.: 1106903
 Eurocode: 3556ASCHB
 Fig. No.: 51

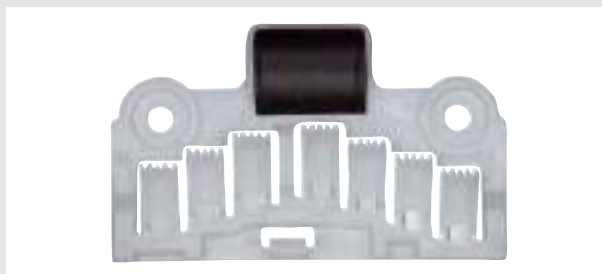

Art. No. 0501 302 006
 Orig. No.: 1064022
 Eurocode: 3546ASCHB
 Fig. No.: 52



Art. No. 0501 302 007
 Orig. No.: 1045676
 Eurocode: 3743ASCVB
 Fig. No.: 53

Index sorted by Art. No.						
Art. No.	Orig. No.	Eurocode	Designation	Car type	Fig.	P. Qty.
0362 120 15	1470843		WHEEL NUT M12 x 1.5 BK 19 HEIGHT 15 MM QUALITY 10*	-	45	50
0362 14 15	1377748		WHEEL NUT M14x1.5 21 MM GALV. CLR. PASSIV.	GALAXY AB 2006, S-MAX	44	50
0500 053 6	1716235		SHEET-METAL NUT ST 4.2 MM GALV. CLR. PASSIV.	-	15	100
0500 053 7	1450293		SHEET-METAL NUT ST 4.8 MM GALV. CLR. PASSIV.	-	16	100
0500 053 7	0207266		SHEET-METAL NUT ST 4.8 MM GALV. CLR. PASSIV.	-	16	100
0500 111 82	1507374		SPRING NUT 4.0 MM GALV. CLR. PASSIV.	-	29	100
0500 113 46	237929		SHEET-METAL NUT ST 3.9 MM GALV. CLR. PASSIV.	-	13	50
0500 113 62	222026		SHEET-METAL NUT ST 4.2 MM GALV. CLR. PASSIV.	-	14	100
0500 113 69	0227326		SHEET-METAL NUT ST 6.3 MM GALV. CLR. PASSIV. MATT	-	17	100
0500 114 04	6031840		SHEET-METAL NUT ST 6.3 MM GALV. CLR. PASSIV. MATT	FIESTA	18	100
0500 114 04	6738766		SHEET-METAL NUT ST 6.3 MM GALV. CLR. PASSIV. MATT	FIESTA	18	100
0500 114 27	1470998		SHEET-METAL NUT ST 6.3 MM GALV.	UNIVERSAL	19	100
0500 116 39	0537655		PAPERBOARD CLIP GALV. CLR.	-	43	25
0500 121 9	1474663		SHEET-METAL NUT ST 3.5 MM GALV. CLR. PASSIV.	-	12	100
0500 125 51	1480335		BLACK COVER PLUG	-	5	25
0500 133	6028434		ALUMIN./STEEL BLIND RIVET A2	-	24	50
0500 145 45	1629279		COVER PLUG POM BLACK	ESCORT, FIESTA	8	25
0500 145 45	6725950		COVER PLUG POM BLACK	ESCORT, FIESTA	8	25
0500 292 9	1629549		THREADED BLIND RIVET PA BLACK	UNIVERSAL	47	50
0500 292 9	6743363		THREADED BLIND RIVET PA BLACK	UNIVERSAL	47	50
0500 307 71	1473931		SPRING COTTERS A2*	-	30	50
0500 405 0	6117693		INTERIOR LINING CLIP POM COLORLESS	ESCORT, FIESTA	37	100
0500 408 0	6740771		SHEET-METAL NUT M 6 SELF-LOCKING M GALV. CLR. PASSIV. TNT	UNIVERSAL	20	25
0500 408 0	4852244		SHEET-METAL NUT M 6 SELF-LOCKING M GALV. CLR. PASSIV. TNT	UNIVERSAL	20	25
0500 411			BLACK PLASTIC BLIND RIVET 5.0 x 12.0	-	26	100
0500 8	1443038		BLACK COVER PLUG	FIESTA	4	50
0500 921 9	1489595		BLACK FIR-TREE CLIP	-	3	25
0500 937 7	7200671		PLASTIC SPLIT RIVET PA 66 DARK GRAY	GALAXY	33	100
0500 940 5	1629082		FIR-TREE CLIP PA BLACK	-	7	25
0501 101 621	1065204		BLACK INTERIOR LINING CLIP	GALAXY 1+2	11	50
0501 101 631	1416795		EXPANDING NUT PA 66 COLORLESS	FIESTA	36	100
0501 101 649	6715468		QUICKY FOR T-BOLT 5 X 30 MM GEO PLUS	C-MAX, COUGAR, ESCORT, FOCUS 98 - 05, GRANADA, KA, MONDEO, ORION, PUMA, SCORPIO, SIERRA, TRANSIT	27	100
0501 101 659	1008086		YELLOW INTERIOR LINING CLIP	GALAXY 1+2, FOCUS	41	100
0501 102 001	6105034		ROD RETAINER DIA. 7.0 - 21.0 MM POM BLACK	ESCORT, FIESTA	31	25
0501 102 005	6103426		SHEET-METAL NUT M 8 GALV. CLR. PASSIV.	UNIVERSAL	22	100
0501 102 006	1500238		EXPANDING NUT PA 6 GF 15 BLACK	FIESTA	34	100
0501 102 008	6150260		COLORLESS EXPANDING NUT	KA, FIESTA, ESCORT, MONDEO	35	100
0501 102 009	1257376		INTERIOR LINING CLIP POM BLACK	FOCUSMAX	39	25
0501 102 010	1020732		INTERIOR LINING CLIP POM BLACK WITH WHITE BASE	UNIVERSAL	40	100
0501 102 012	1106903	3556ASCHB	FASTENER POLLEN FILTER COVER	FOCUS 1999-2005	51	25

Index sorted by Art. No.						
Art. No.	Orig. No.	Eurocode	Designation	Car type	Fig.	P. Qty.
0501 102 021	6678518		COVER PLUG BLACK PA 6.6	COUGAR, ESCORT, FIESTA, FOCUS 98 - 05, KA, MONDEO, PUMA, STREET KA, TRANSIT	2	50
0501 102 022	6786759		BLACK COVER PLUG POM	KA	9	25
0501 102 023	1018434		GRAY COVER PLUG POM	ESCORT, FIESTA	10	50
0501 102 024	6176723		INTERIOR LINING CLIP POM COLORLESS	FIESTA 89 - 96, ESCORT FROM 95, KA FROM 97	38	25
0501 102 024	6117693		INTERIOR LINING CLIP POM COLORLESS	FIESTA 89 - 96, ESCORT FROM 95, KA FROM 97	38	25
0501 102 025	1022510	3546ASCHB1B	WINDOW CLIP PP BLACK	KA, MONDEO FROM 93	50	10
0501 102 026	6089805		SHEET-METAL NUT M 8 GALV. CLR. PASSIV. SELF-LOCKING	-	23	10
0501 103 035	1009164		PLASTIC SPLIT RIVET PA 661 BLACK	UNIVERSAL	32	25
0501 104 120	E824115S74		SHEET-METAL NUT M 5 MET. CORR. PROT. 2.2 BK	-	21	100
0501 105 113	1503837		SPRING NUT 3.0 MM GALV.	-	28	100
0501 105 601	1079129		BLACK FIR-TREE CLIP	FOCUS FROM 98, MONDEO	1	25
0501 105 601	6998849		BLACK FIR-TREE CLIP	FOCUS FROM 98, MONDEO	1	25
0501 302 001	6059465	3541ASCH	BLIND RIVET 4.0 X 8.0 ALU/STEEL SLEEVE PAINTED BLACK	SCORPIO	25	25
0501 302 002	1020193	3546ASCHB2B	INTERIOR LINING CLIP POM BLACK	MONDEO	42	25
0501 302 003	6114021	3731ASCV6B	THREADED BLIND RIVET PA 66 BLACK	FIESTA, ESCORT, SIERRA, MONDEO, TRANSIT II	46	25
0501 302 004	4069907	3739ASCVS	WINDOW CLIP FORD SHORT WHITE	TRANSIT	48	25
0501 302 004	4494056	3739ASCVS	WINDOW CLIP FORD SHORT WHITE	TRANSIT	48	25
0501 302 005	4069906	3739ASCVS1B	WINDOW CLIP FORD LONG BLACK	TRANSIT	49	25
0501 302 005	4494055	3739ASCVS1B	WINDOW CLIP FORD LONG BLACK	TRANSIT	49	25
0501 302 006	1064022	3546ASCHB	WINDOW CLIP PP 104 COLORLESS + RUBBER PIECE BK	MONDEO	52	25
0501 302 007	1045676	3743ASCVB	WINDOW CLIP PP 105 COLORLESS + DOUBLED-SIDED ADHESIVE TAPE	TRANSIT, ESCORT IV	53	25
0501 321 001	6049625	6537ASCV6B	BLACK FIR-TREE CLIP	-	6	25

Index sorted by Orig. No.						
Orig. No.	Art. No.	Eurocode	Designation	Car type	Fig.	P. Qty.
	0500 411		BLACK PLASTIC BLIND RIVET 5.0 x 12.0	-	26	100
0227326	0500 113 69		SHEET-METAL NUT ST 6.3 MM GALV. CLR. PASSIV. MATT	-	17	100
0537655	0500 116 39		PAPERBOARD CLIP GALV. CLR.	-	43	25
1008086	0501 101 659		YELLOW INTERIOR LINING CLIP	GALAXY 1+2, FOCUS	41	100
1009164	0501 103 035		PLASTIC SPLIT RIVET PA 661 BLACK	UNIVERSAL	32	25
1018434	0501 102 023		GRAY COVER PLUG POM	ESCORT, FIESTA	10	50
1020193	0501 302 002	3546ASCHB2B	INTERIOR LINING CLIP POM BLACK	MONDEO	42	25
1020732	0501 102 010		INTERIOR LINING CLIP POM BLACK WITH WHITE BASE	UNIVERSAL	40	100
1022510	0501 102 025	3546ASCHB1B	WINDOW CLIP PP BLACK	KA, MONDEO FROM 93	50	10
1045676	0501 302 007	3743ASCVB	WINDOW CLIP PP 105 COLORLESS + DOUBLED-SIDED ADHESIVE TAPE	TRANSIT, ESCORT IV	53	25
1064022	0501 302 006	3546ASCHB	WINDOW CLIP PP 104 COLORLESS + RUBBER PIECE BK	MONDEO	52	25
1065204	0501 101 621		BLACK INTERIOR LINING CLIP	GALAXY 1+2	11	50
1079129	0501 105 601		BLACK FIR-TREE CLIP	FOCUS FROM 98, MONDEO	1	25
6998849	0501 105 601		BLACK FIR-TREE CLIP	FOCUS FROM 98, MONDEO	1	25
1106903	0501 102 012	3556ASCHB	FASTENER POLLEN FILTER COVER	FOCUS 1999-2005	51	25
1257376	0501 102 009		INTERIOR LINING CLIP POM BLACK	FOCUSMAX	39	25
1377748	0362 14 15		WHEEL NUT M14x1.5 21 MM GALV. CLR. PASSIV.	GALAXY AB 2006, S-MAX	44	50
1416795	0501 101 631		EXPANDING NUT PA 66 COLORLESS	FIESTA	36	100
1443038	0500 8		BLACK COVER PLUG	FIESTA	4	50
1450293	0500 053 7		SHEET-METAL NUT ST 4.8 MM GALV. CLR. PASSIV.	-	16	100
0207266	0500 053 7		SHEET-METAL NUT ST 4.8 MM GALV. CLR. PASSIV.	-	16	100
1470843	0362 120 15		WHEEL NUT M12 x 1.5 BK 19 HEIGHT 15 MM QUALITY 10*	-	45	50
1470998	0500 114 27		SHEET-METAL NUT ST 6.3 MM GALV.	UNIVERSAL	19	100
1473931	0500 307 71		SPRING COTTERS A2*	-	30	50
1474663	0500 121 9		SHEET-METAL NUT ST 3.5 MM GALV. CLR. PASSIV.	-	12	100
1480335	0500 125 51		BLACK COVER PLUG	-	5	25
1489595	0500 921 9		BLACK FIR-TREE CLIP	-	3	25
1500238	0501 102 006		EXPANDING NUT PA 6 GF 15 BLACK	FIESTA	34	100
1503837	0501 105 113		SPRING NUT 3.0 MM GALV.	-	28	100
1507374	0500 111 82		SPRING NUT 4.0 MM GALV. CLR. PASSIV.	-	29	100
1629082	0500 940 5		FIR-TREE CLIP PA BLACK	-	7	25
1629279	0500 145 45		COVER PLUG POM BLACK	ESCORT, FIESTA	8	25
6725950	0500 145 45		COVER PLUG POM BLACK	ESCORT, FIESTA	8	25
1629549	0500 292 9		THREADED BLIND RIVET PA BLACK	UNIVERSAL	47	50
6743363	0500 292 9		THREADED BLIND RIVET PA BLACK	UNIVERSAL	47	50
1716235	0500 053 6		SHEET-METAL NUT ST 4.2 MM GALV. CLR. PASSIV.	-	15	100
222026	0500 113 62		SHEET-METAL NUT ST 4.2 MM GALV. CLR. PASSIV.	-	14	100
237929	0500 113 46		SHEET-METAL NUT ST 3.9 MM GALV. CLR. PASSIV.	-	13	50
4069906	0501 302 005	3739ASCVS1B	WINDOW CLIP FORD LONG BLACK	TRANSIT	49	25
4494055	0501 302 005	3739ASCVS1B	WINDOW CLIP FORD LONG BLACK	TRANSIT	49	25
4069907	0501 302 004	3739ASCVS	WINDOW CLIP FORD SHORT WHITE	TRANSIT	48	25
4494056	0501 302 004	3739ASCVS	WINDOW CLIP FORD SHORT WHITE	TRANSIT	48	25
6028434	0500 133		ALUMIN./STEEL BLIND RIVET A2	-	24	50

Index sorted by Orig. No.						
Orig. No.	Art. No.	Eurocode	Designation	Car type	Fig.	P. Qty.
6031840	0500 114 04		SHEET-METAL NUT ST 6.3 MM GALV. CLR. PASSIV. MATT	FIESTA	18	100
6738766	0500 114 04		SHEET-METAL NUT ST 6.3 MM GALV. CLR. PASSIV. MATT	FIESTA	18	100
6049625	0501 321 001	6537ASCV6B	BLACK FIR-TREE CLIP	-	6	25
6059465	0501 302 001	3541ASCH	BLIND RIVET 4.0 X 8.0 ALU/STEEL SLEEVE PAINTED BLACK	SCORPIO	25	25
6089805	0501 102 026		SHEET-METAL NUT M 8 GALV. CLR. PASSIV. SELF-LOCKING	-	23	10
6103426	0501 102 005		SHEET-METAL NUT M 8 GALV. CLR. PASSIV.	UNIVERSAL	22	100
6105034	0501 102 001		ROD RETAINER DIA. 7.0 - 21.0 MM POM BLACK	ESCORT, FIESTA	31	25
6114021	0501 302 003	3731ASCV6B	THREADED BLIND RIVET PA 66 BLACK	FIESTA, ESCORT, SIERRA, MONDEO, TRANSIT II	46	25
6117693	0500 405 0		INTERIOR LINING CLIP POM COLORLESS	ESCORT, FIESTA	37	100
6150260	0501 102 008		COLORLESS EXPANDING NUT	KA, FIESTA, ESCORT, MON- DEO	35	100
6176723	0501 102 024		INTERIOR LINING CLIP POM COLORLESS	FIESTA 89 - 96, ESCORT FROM 95, KA FROM 97	38	25
6117693	0501 102 024		INTERIOR LINING CLIP POM COLORLESS	FIESTA 89 - 96, ESCORT FROM 95, KA FROM 97	38	25
6678518	0501 102 021		COVER PLUG BLACK PA 6.6	COUGAR, ESCORT, FIESTA, FOCUS 98 - 05, KA, MON- DEO, PUMA, STREET KA, TRANSIT	2	50
6715468	0501 101 649		QUICKY FOR T-BOLT 5 X 30 MM GEO PLUS	C-MAX, COUGAR, ESCORT, FOCUS 98 - 05, GRANADA, KA, MONDEO, ORION, PUMA, SCORPIO, SIERRA, TRANSIT	27	100
6740771	0500 408 0		SHEET-METAL NUT M 6 SELF-LOCKING M GALV. CLR. PASSIV. TNT	UNIVERSAL	20	25
4852244	0500 408 0		SHEET-METAL NUT M 6 SELF-LOCKING M GALV. CLR. PASSIV. TNT	UNIVERSAL	20	25
6786759	0501 102 022		BLACK COVER PLUG POM	KA	9	25
7200671	0500 937 7		PLASTIC SPLIT RIVET PA 66 DARK GRAY	GALAXY	33	100
E824115S74	0501 104 120		SHEET-METAL NUT M 5 MET. CORR. PROT. 2.2 BK	-	21	100

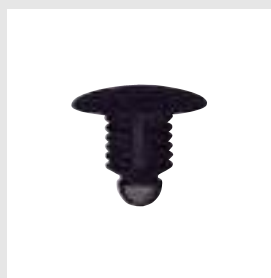

Art. No. 0500 785 016
 Orig. No.: 91606SE30030
 Fig. No.: 1

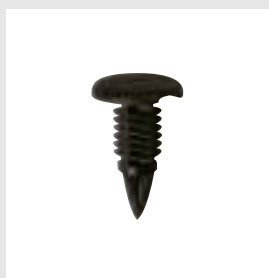

Art. No. 0500 785 055
 Orig. No.: 906666890030
 Fig. No.: 2



Art. No. 0501 129 010
 Orig. No.: 90671SB3003YD
 Fig. No.: 3

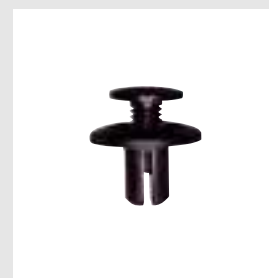

Art. No. 0501 129 004
 Orig. No.: 90657SH3013
 Fig. No.: 4



Art. No. 0501 329 001
 Orig. No.: 91508SM4003
 Eurocode: 3936ASCS
 Fig. No.: 5

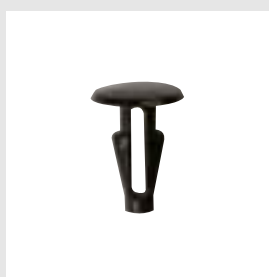

Art. No. 0500 785 021
 Orig. No.: 90672671003
 Fig. No.: 6

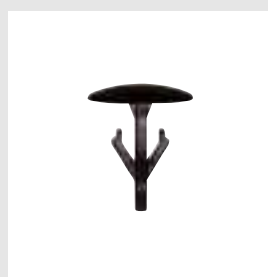

Art. No. 0501 329 002
 Orig. No.: 91501SM4003
 Eurocode: 3936ASCSB
 Fig. No.: 7



Art. No. 0500 785 060
 Orig. No.: 906566716300
 90656671631
 Fig. No.: 8



Art. No. 0500 785 006
 Orig. No.: 906626710030
 Fig. No.: 9



Art. No. 0500 785 044
 Orig. No.: 755226110000
 Fig. No.: 10



Art. No. 0500 785 045
 Orig. No.: 906726718110M
 Fig. No.: 11

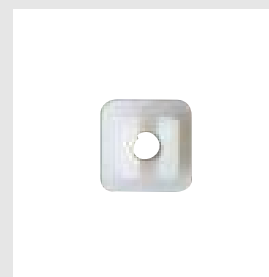

Art. No. 0500 785 046
 Orig. No.: 75521611000
 Fig. No.: 12



Art. No. 0500 785 040
 Orig. No.: 389936348100
 Fig. No.: 13

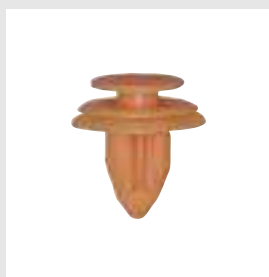

Art. No. 0501 129 005
 Orig. No.: 91560S6A003
 Fig. No.: 14



Art. No. 0501 129 006
 Orig. No.: 91560S9AA01
 Fig. No.: 15



Art. No. 0501 129 007
 Orig. No.: 91560S9AA51
 Fig. No.: 16



Art. No. 0501 129 011
 Orig. No.: 91566SP0003
 Fig. No.: 17

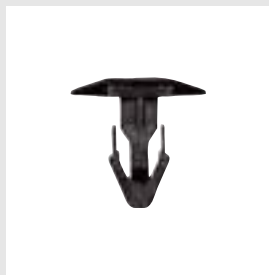

Art. No. 0501 329 003
 Orig. No.: 91515SR3000
 Eurocode: 3962ASCRB
 Fig. No.: 18



Art. No. 0501 329 004
 Orig. No.: 91517SJ4003
 Eurocode: 7016ASCH
 3943AKCH
 Fig. No.: 19

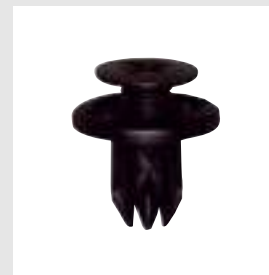

Art. No. 0501 129 002
 Orig. No.: 91503SP0003
 Fig. No.: 20

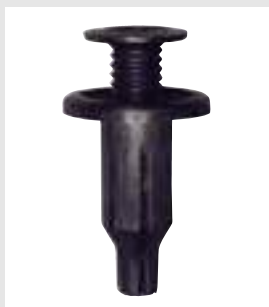

Art. No. 0501 129 012
 Orig. No.: 91502SP0003
 Fig. No.: 21



Art. No. 0500 785 087
 Orig. No.: 90675SB0003
 Fig. No.: 22



Art. No. 0500 785 074
 Orig. No.: 90668SC5003
 Fig. No.: 23



Art. No. 0500 785 078
 Orig. No.: 90687SB0003
 Fig. No.: 24

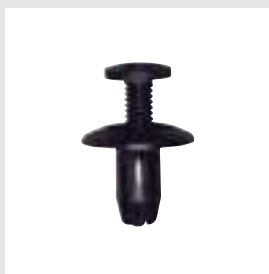

Art. No. 0500 785 083
 Orig. No.: 90684SA5003
 Fig. No.: 25



Art. No. 0500 785 084
 Orig. No.: 90688SB0003
 Fig. No.: 26



Art. No. 0500 785 085
 Orig. No.: 90683SA5003
 Fig. No.: 27



Art. No. 0500 785 082
 Orig. No.: 90664671003
 Fig. No.: 28



Art. No. 0501 329 005
 Orig. No.: 91519S5A003
 Eurocode: 3974ASCHS
 Fig. No.: 29



Art. No. 0501 329 006
 Orig. No.: 91520SR3003
 Eurocode: 3940ASCS
 Fig. No.: 30



Art. No. 0501 129 013
Orig. No.: 91501S04003
91512S04003
Fig. No.: 31



Art. No. 0501 129 003
Orig. No.:
Fig. No.: 32



Art. No. 0501 129 001
Orig. No.: 91503SZ3003
Fig. No.: 33



Art. No. 0501 129 014
Orig. No.: 91503SZ5003
Fig. No.: 34

Index sorted by Art. No.						
Art. No.	Orig. No.	Eurocode	Designation	Car type	Fig.	P. Qty.
0500 785 006	906626710030		COLORLESS EXPANDING NUT HONDA*	-	9	25
0500 785 016	91606SE30030		BLACK FIR-TREE CLIP HONDA*	ACCORD 99 - 02, PRELUDE 89 - 91	1	25
0500 785 021	90672671003		PLASTIC RIVET WITHOUT PIN PA 66 BLACK	ACCORD 83 - 89, CIVIC 80 - 87, CRX 84 - 87, INTEGRA, LEGEND, PRELUDE 79 - 87	6	25
0500 785 040	389936348100		COLORLESS INTERIOR LINING CLIP*	-	13	25
0500 785 044	755226110000		COLORLESS EXPANDING NUT HONDA*	ACCORD, CIVIC, CRX, INTEGRA, LEGEND, LOGO, NSX, ODYSSEY, PRELUDE	10	25
0500 785 045	906726718110M		EXPANDING NUT WITH FOAM DISK HONDA*	ACCORD, CIVIC, CRV, LEGEND, NSX, PRELUDE	11	25
0500 785 046	75521611000		COLORLESS EXPANDING NUT HONDA*	-	12	25
0500 785 055	906666890030		BLACK FIR-TREE CLIP HONDA*	UNIVERSAL	2	25
0500 785 060	906566716300		COLORLESS EXPANDING NUT HONDA*	CIVIC, PRELUDE	8	25
0500 785 060	90656671631		COLORLESS EXPANDING NUT HONDA*	CIVIC, PRELUDE	8	25
0500 785 074	90668SC5003		THREADED BLIND RIVET PA 6 BLACK HONDA*	-	23	25
0500 785 078	90687SB0003		BLACK THREADED BLIND RIVET HONDA*	ACCORD TOURER, STREAM	24	25
0500 785 082	90664671003		COLORLESS DOOR SEAL CLIP*	ACCORD 76 - 89, CIVIC 89 - 91, CRX 84 - 91, NSX 97 - 01, PRELUDE 79 - 96	28	25
0500 785 083	90684SA5003		BLACK THREADED BLIND RIVET HONDA*	-	25	25
0500 785 084	90688SB0003		BLACK THREADED BLIND RIVET HONDA*	CIVIC 92 - 00, CRV 00 - 01, INTEGRA, LEGEND, ODYSSEY 01 - 04, PRELUDE 83 - 87	26	25
0500 785 085	90683SA5003		BLACK THREADED BLIND RIVET HONDA*	-	27	25
0500 785 087	90675SB0003		BLACK THREADED BLIND RIVET*	-	22	25
0501 129 001	91503SZ3003		BLACK RECURSION RIVET HONDA*	ACCORD FROM 97, CIVIC FROM 97, CRV FROM 97, JAZZ FROM 05, ODYSSEY FROM 96, FRV, HRV, INTEGRA, LEGEND, NSX	33	25
0501 129 002	91503SP0003		BLACK THREADED BLIND RIVET*	ACCORD 92 - 97, CIVIC 01 - 02, CONCERTO, CRX, LEGEND 91 - 95, PRELUDE 92 - 96	20	25
0501 129 003			RECURSION RIVET POM BLACK *	-	32	25
0501 129 004	90657SH3013		BLACK PLASTIC SPLIT RIVET*	-	4	25
0501 129 005	91560S6A003		ORANGE INTERIOR LINING CLIP *	ACCORD 08, CIVIC 05, CRV 02, JAZZ, ODYSSEY 05	14	50
0501 129 006	91560S9AA01		BLUE INTERIOR LINING CLIP *	ACCORD 03 - 07, CIVIC 02 - 05, CRV 08, ODYSSEY 05	15	50
0501 129 007	91560S9AA51		COLORLESS INTERIOR LINING CLIP *	-	16	50
0501 129 010	90671SB3003YD		COVER PLUG PA GRAY*	-	3	10
0501 129 011	91566SP0003		INTERIOR LINING CLIP POM COLORLESS *	-	17	10
0501 129 012	91502SP0003		THREADED BLIND RIVET POM BLACK*	ACCORD 92 - 97	21	10
0501 129 013	91501S04003		RECURSION RIVET POM BLACK*	ACCORD FROM 96, CIVIC FROM 96, CRV FROM 97, HRV, JAZZ FROM 07	31	10
0501 129 013	91512S04003		RECURSION RIVET POM BLACK*	ACCORD FROM 96, CIVIC FROM 96, CRV FROM 97, HRV, JAZZ FROM 07	31	10
0501 129 014	91503SZ5003		RECURSION RIVET PP + POM BLACK *	UNIVERSAL	34	10
0501 329 001	91508SM4003	3936ASCS	PLASTIC SPLIT RIVET BK WITH FOAM SEAL BK*	ACCORD 90 - 00, CIVIC, LEGEND 96 - 00	5	25

Index sorted by Art. No.						
Art. No.	Orig. No.	Eurocode	Designation	Car type	Fig.	P. Qty.
0501 329 002	91501SM4003	3936ASCSB	PLASTIC RIVET WITHOUT PIN POM BLACK*	-	7	25
0501 329 003	91515SR3000	3962ASCRB	TRIM CLIP PA 6 BLACK *	BALLADE, CITY, CIVIC 92 - 2000	18	25
0501 329 004	91517SJ4003	7016ASCH 3943AKCH	TRIM CLIP POM NATURAL WITH SEAL BLACK*	CONCERTO SJ4 91 - 95	19	25
0501 329 005	91519S5A003	3974ASCHS	WINDOW CLIP POM BLACK HONDA *	-	29	25
0501 329 006	91520SR3003	3940ASCS	RED WINDOW CLIP	CIVIC 91, INTEGRA, ACCORD	30	25

Index sorted by Orig. No.						
Orig. No.	Art. No.	Eurocode	Designation	Car type	Fig.	P. Qty.
	0501 129 003		RECURSION RIVET POM BLACK *	-	32	25
389936348100	0500 785 040		COLORLESS INTERIOR LINING CLIP*	-	13	25
75521611000	0500 785 046		COLORLESS EXPANDING NUT HONDA*	-	12	25
755226110000	0500 785 044		COLORLESS EXPANDING NUT HONDA*	ACCORD, CIVIC, CRX, INTEGRA, LEGEND, LOGO, NSX, ODYSSEY, PRELUDE	10	25
906566716300	0500 785 060		COLORLESS EXPANDING NUT HONDA*	CIVIC, PRELUDE	8	25
90656671631	0500 785 060		COLORLESS EXPANDING NUT HONDA*	CIVIC, PRELUDE	8	25
90657SH3013	0501 129 004		BLACK PLASTIC SPLIT RIVET*	-	4	25
906626710030	0500 785 006		COLORLESS EXPANDING NUT HONDA*	-	9	25
90664671003	0500 785 082		COLORLESS DOOR SEAL CLIP*	ACCORD 76 - 89, CIVIC 89 - 91, CRX 84 - 91, NSX 97 - 01, PRELUDE 79 - 96	28	25
906666890030	0500 785 055		BLACK FIR-TREE CLIP HONDA*	UNIVERSAL	2	25
90668SC5003	0500 785 074		THREADED BLIND RIVET PA 6 BLACK HONDA*	-	23	25
90671SB3003YD	0501 129 010		COVER PLUG PA GRAY*	-	3	10
90672671003	0500 785 021		PLASTIC RIVET WITHOUT PIN PA 66 BLACK	ACCORD 83 - 89, CIVIC 80 - 87, CRX 84 - 87, INTEGRA, LEGEND, PRELUDE 79 - 87	6	25
906726718110M	0500 785 045		EXPANDING NUT WITH FOAM DISK HONDA*	ACCORD, CIVIC, CRV, LEGEND, NSX, PRELUDE	11	25
90675SB0003	0500 785 087		BLACK THREADED BLIND RIVET*	-	22	25
90683SA5003	0500 785 085		BLACK THREADED BLIND RIVET HONDA*	-	27	25
90684SA5003	0500 785 083		BLACK THREADED BLIND RIVET HONDA*	-	25	25
90687SB0003	0500 785 078		BLACK THREADED BLIND RIVET HONDA*	ACCORD TOURER, STREAM	24	25
90688SB0003	0500 785 084		BLACK THREADED BLIND RIVET HONDA*	CIVIC 92 - 00, CRV 00 - 01, INTEGRA, LEGEND, ODYSSEY 01 - 04, PRELUDE 83 - 87	26	25
91501S04003	0501 129 013		RECURSION RIVET POM BLACK*	ACCORD FROM 96, CIVIC FROM 96, CRV FROM 97, HRV, JAZZ FROM 07	31	10
91512S04003	0501 129 013		RECURSION RIVET POM BLACK*	ACCORD FROM 96, CIVIC FROM 96, CRV FROM 97, HRV, JAZZ FROM 07	31	10
91501SM4003	0501 329 002	3936ASCSB	PLASTIC RIVET WITHOUT PIN POM BLACK*	-	7	25
91502SP0003	0501 129 012		THREADED BLIND RIVET POM BLACK*	ACCORD 92 - 97	21	10
91503SP0003	0501 129 002		BLACK THREADED BLIND RIVET*	ACCORD 92 - 97, CIVIC 01 - 02, CONCERTO, CRX, LEGEND 91 - 95, PRELUDE 92 - 96	20	25
91503SZ3003	0501 129 001		BLACK RECURSION RIVET HONDA*	ACCORD FROM 97, CIVIC FROM 97, CRV FROM 97, JAZZ FROM 05, ODYSSEY FROM 96, FRV, HRV, INTEGRA, LEGEND, NSX	33	25
91503SZ5003	0501 129 014		RECURSION RIVET PP + POM BLACK *	UNIVERSAL	34	10
91508SM4003	0501 329 001	3936ASCS	PLASTIC SPLIT RIVET BK WITH FOAM SEAL BK*	ACCORD 90 - 00, CIVIC, LEGEND 96 - 00	5	25
91515SR3000	0501 329 003	3962ASCRB	TRIM CLIP PA 6 BLACK *	BALLADE, CITY, CIVIC 92 - 2000	18	25
91517SJ4003	0501 329 004	7016ASCH 3943AKCH	TRIM CLIP POM NATURAL WITH SEAL BLACK*	CONCERTO SJ4 91 - 95	19	25
91519S5A003	0501 329 005	3974ASCHS	WINDOW CLIP POM BLACK HONDA *	-	29	25

Index sorted by Orig. No.						
Orig. No.	Art. No.	Eurocode	Designation	Car type	Fig.	P. Qty.
91520SR3003	0501 329 006	3940ASCS	RED WINDOW CLIP	CIVIC 91, INTEGRA, ACCORD	30	25
91560S6A003	0501 129 005		ORANGE INTERIOR LINING CLIP *	ACCORD 08, CIVIC 05, CRV 02, JAZZ, ODYSSEY 05	14	50
91560S9AA01	0501 129 006		BLUE INTERIOR LINING CLIP *	ACCORD 03 - 07, CIVIC 02 - 05, CRV 08, ODYSSEY 05	15	50
91560S9AA51	0501 129 007		COLORLESS INTERIOR LINING CLIP *	-	16	50
91566SP0003	0501 129 011		INTERIOR LINING CLIP POM COLORLESS *	-	17	10
91606SE30030	0500 785 016		BLACK FIR-TREE CLIP HONDA*	ACCORD 99 - 02, PRELUDE 89 - 91	1	25



Art. No. 0500 785 045

Orig. No.: 9751922000

Fig. No.: 1

Index sorted by Art. No.						
Art. No.	Orig. No.	Eurocode	Designation	Car type	Fig.	P. Qty.
0500 785 045	9751922000		EXPANDING NUT WITH FOAM DISK HONDA*	-	1	25

Index sorted by Orig. No.						
Orig. No.	Art. No.	Eurocode	Designation	Car type	Fig.	P. Qty.
9751922000	0500 785 045		EXPANDING NUT WITH FOAM DISK HONDA*	-	1	25



Art. No. 0500 777 3
Orig. No.: 0K20150033
Fig. No.: 1

Index sorted by Art. No.						
Art. No.	Orig. No.	Eurocode	Designation	Car type	Fig.	P. Qty.
0500 777 3	OK20150033		BLACK THREADED BLIND RIVET TOYOTA *	CARENS I + II, SHUMA, SPORTAGE	1	25

Index sorted by Orig. No.						
Orig. No.	Art. No.	Eurocode	Designation	Car type	Fig.	P. Qty.
OK20150033	0500 777 3		BLACK THREADED BLIND RIVET TOYOTA *	CARENS I + II, SHUMA, SPORTAGE	1	25



Art. No. 0500 789 059
Orig. No.: 813350022
Fig. No.: 1

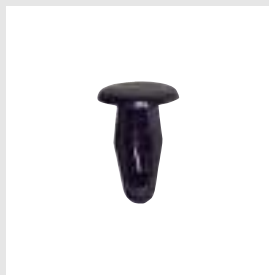

Art. No. 0500 788 028
Orig. No.:
Fig. No.: 2



Art. No. 0500 789 006
Orig. No.: 992640531B
Fig. No.: 3

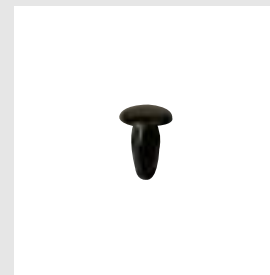

Art. No. 0500 789 051
Orig. No.:
Fig. No.: 4

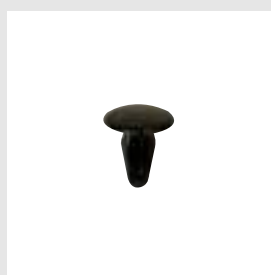

Art. No. 0500 789 056
Orig. No.: 992640426
Fig. No.: 5

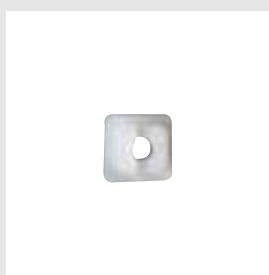

Art. No. 0500 785 044
Orig. No.: 999100412
Fig. No.: 6



Art. No. 0500 788 018
Orig. No.: 999100404
Fig. No.: 7

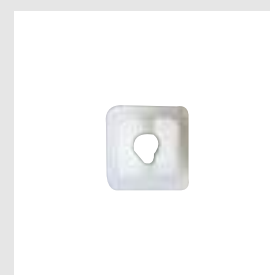

Art. No. 0500 789 068
Orig. No.: 999100501
Fig. No.: 8

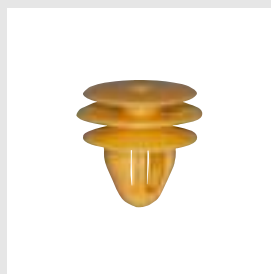

Art. No. 0501 131 001
Orig. No.: GA2K68AB1
Fig. No.: 9



Art. No. 0501 131 006
Orig. No.: D20150797
Eurocode: 5157ASCVB
Fig. No.: 10



Art. No. 0500 770 6
Orig. No.: 992740825
Fig. No.: 11



Art. No. 0362 112 15
Orig. No.: 060326161
Fig. No.: 12



Art. No. 0501 131 002
Orig. No.: NA0156145
Fig. No.: 13



Art. No. 0501 131 007
Orig. No.: BF8250233
Fig. No.: 14



Art. No. 0501 131 003
Orig. No.: BC1D56145
Fig. No.: 15



Art. No. 0501 131 004
Orig. No.: B46768AC3
Fig. No.: 16



Art. No. 0501 131 005

Orig. No.: GJ2168885B

Fig. No.: 17

Index sorted by Art. No.						
Art. No.	Orig. No.	Eurocode	Designation	Car type	Fig.	P. Qty.
0362 112 15	060326161		WHEEL NUT M12x1.5 21 MM GALV. 3*	-	12	100
0500 770 6	992740825		INTERIOR LINING CLIP TOYOTA*	UNIVERSAL	11	25
0500 785 044	999100412		COLORLESS EXPANDING NUT HONDA*	323, 626, 929	6	25
0500 788 018	999100404		COLORLESS EXPANDING NUT FOR DATSUN/MAZDA*	-	7	25
0500 788 028			PLASTIC RIVET PA 6 BLACK DATSUN/MAZDA*	-	2	25
0500 789 006	992640531B		BLACK PLASTIC RIVET MAZDA*	323, 626, RX-7	3	25
0500 789 051			BLACK PLASTIC RIVET MAZDA*	-	4	25
0500 789 056	992640426		PLASTIC RIVET PA 6 BLACK MAZDA*	929, MX-3, RX-7	5	25
0500 789 059	813350022		BLACK COVER PLUG MAZDA*	-	1	25
0500 789 068	999100501		COLORLESS EXPANDING NUT MAZDA*	UNIVERSAL	8	25
0501 131 001	GA2K68AB1		YELLOW INTERIOR LINING CLIP*	-	9	25
0501 131 002	NA0156145		BLACK THREADED BLIND RIVET*	-	13	25
0501 131 003	BC1D56145		BLACK RECURSION RIVET*	UNIVERSAL	15	25
0501 131 004	B46768AC3		BLACK RECURSION RIVET*	-	16	25
0501 131 005	GJ2168885B		GRAY RECURSION RIVET*	-	17	25
0501 131 006	D20150797	5157ASCVB	INTERIOR LINING CLIP POM COLORLESS WITH SEAL BLACK*	MPV	10	10
0501 131 007	BF8250233		THREADED BLIND RIVET PA BLACK *	UNIVERSAL	14	5

Index sorted by Orig. No.						
Orig. No.	Art. No.	Eurocode	Designation	Car type	Fig.	P. Qty.
	0500 788 028		PLASTIC RIVET PA 6 BLACK DATSUN/MAZDA*	-	2	25
060326161	0362 112 15		WHEEL NUT M12x1.5 21 MM GALV. 3*	-	12	100
813350022	0500 789 059		BLACK COVER PLUG MAZDA*	-	1	25
992640426	0500 789 056		PLASTIC RIVET PA 6 BLACK MAZDA*	929, MX-3, RX-7	5	25
992640531B	0500 789 006		BLACK PLASTIC RIVET MAZDA*	323, 626, RX-7	3	25
992740825	0500 770 6		INTERIOR LINING CLIP TOYOTA*	UNIVERSAL	11	25
999100404	0500 788 018		COLORLESS EXPANDING NUT FOR DATSUN/MAZDA*	-	7	25
999100412	0500 785 044		COLORLESS EXPANDING NUT HONDA*	323, 626, 929	6	25
999100501	0500 789 068		COLORLESS EXPANDING NUT MAZDA*	UNIVERSAL	8	25
B46768AC3	0501 131 004		BLACK RECURSION RIVET*	-	16	25
BC1D56145	0501 131 003		BLACK RECURSION RIVET*	UNIVERSAL	15	25
BF8250233	0501 131 007		THREADED BLIND RIVET PA BLACK *	UNIVERSAL	14	5
D20150797	0501 131 006	5157ASCVB	INTERIOR LINING CLIP POM COLORLESS WITH SEAL BLACK*	MPV	10	10
GA2K68AB1	0501 131 001		YELLOW INTERIOR LINING CLIP*	-	9	25
GJ2168885B	0501 131 005		GRAY RECURSION RIVET*	-	17	25
NA0156145	0501 131 002		BLACK THREADED BLIND RIVET*	-	13	25

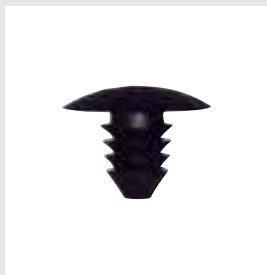

Art. No. 0501 104 105
 Orig. No.: A0009974686
 Fig. No.: 1

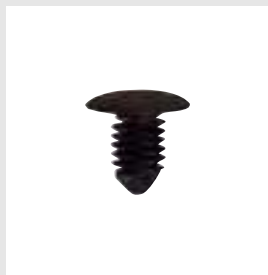

Art. No. 0500 939 6
 Orig. No.: A0009912895
 Fig. No.: 2



Art. No. 0500 132 300
 Orig. No.: A0019971386
 A0009974886
 Fig. No.: 3



Art. No. 0501 104 048
 Orig. No.: 0019979586
 Fig. No.: 4

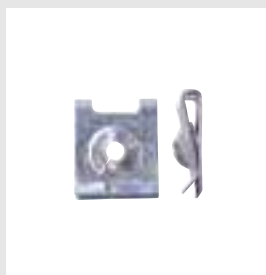

Art. No. 0500 119 56
 Orig. No.: A0009944245
 Fig. No.: 5

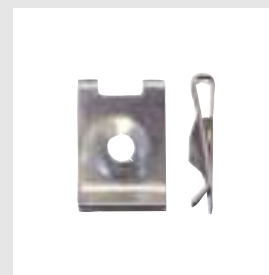

Art. No. 0500 113 62
 Orig. No.: 1409941045
 Fig. No.: 6



Art. No. 0500 117 45
 Orig. No.: 0009942545
 Fig. No.: 7



Art. No. 0500 115 22
 Orig. No.:
 Fig. No.: 8



Art. No. 0500 113 69
 Orig. No.: 0009945045
 Fig. No.: 9

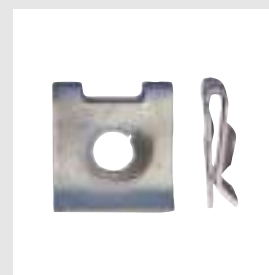

Art. No. 0500 114 04
 Orig. No.: 0009940845
 Fig. No.: 10

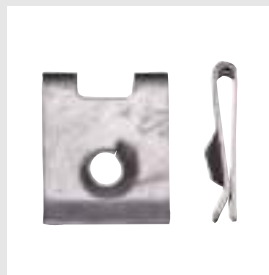

Art. No. 0500 114 70
Orig. No.: 0009941445
Fig. No.: 11

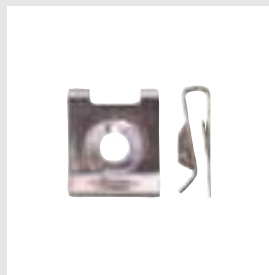

Art. No. 0500 116 67
Orig. No.: 0009942345
Fig. No.: 12



Art. No. 0500 121 98
Orig. No.: A0009944745
Fig. No.: 13

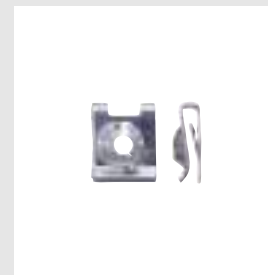

Art. No. 0500 131 74
Orig. No.: 1239940145
Fig. No.: 14



Art. No. 0500 114 27
Orig. No.: 0009940945
Fig. No.: 15



Art. No. 0500 131 33
Orig. No.: 1239940045
Fig. No.: 16

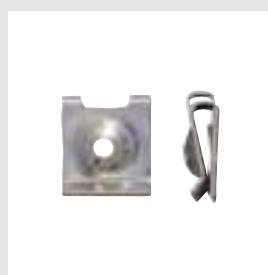

Art. No. 0501 104 064
Orig. No.: A0019945445
Fig. No.: 17



Art. No. 0501 104 119
Orig. No.: A0039941745
Fig. No.: 18

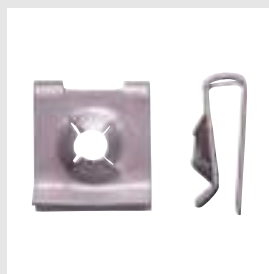

Art. No. 0500 136 37
Orig. No.: 1239941545
Fig. No.: 19



Art. No. 0500 132 19
Orig. No.: A1239940645
Fig. No.: 20



Art. No. 0500 595 0
Orig. No.: A0019900091
Fig. No.: 21

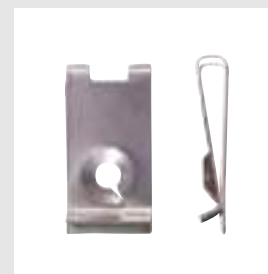

Art. No. 0500 132 51
Orig. No.: 1239940845
Fig. No.: 22



Art. No. 0501 104 120
Orig. No.: A0029942045
Fig. No.: 23



Art. No. 0501 102 005
Orig. No.: A0039941545
Fig. No.: 24



Art. No. 0501 102 026
Orig. No.: A0019905891
Fig. No.: 25

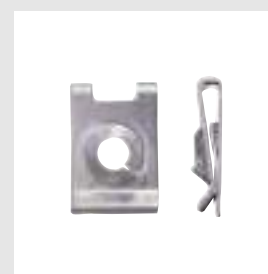

Art. No. 0500 133 84
Orig. No.: A0009940645
Fig. No.: 26



Art. No. 0501 104 065
 Orig. No.: A0019946945
 Fig. No.: 27



Art. No. 0501 104 066
 Orig. No.: A0029948045
 Fig. No.: 28



Art. No. 0501 104 067
 Orig. No.: A0049940645
 A0039948645
 Fig. No.: 29



Art. No. 0501 104 068
 Orig. No.: A0039948945
 Fig. No.: 30



Art. No. 0500 124 63
 Orig. No.: 1149970290
 1149970590
 Fig. No.: 31



Art. No. 0500 125 28
 Orig. No.: 0019974390
 Fig. No.: 32

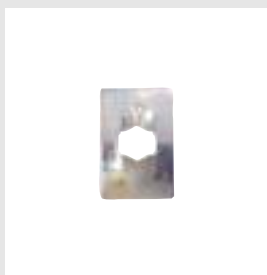

Art. No. 0500 111 82
 Orig. No.: A0009940145
 Fig. No.: 33

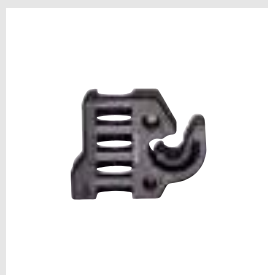

Art. No. 0501 104 069
 Orig. No.: A1299950065
 Fig. No.: 34



Art. No. 0500 113 17
 Orig. No.: 0009881878
 Fig. No.: 35



Art. No. 0129 986 020
 Orig. No.: 914007006014
 Fig. No.: 36

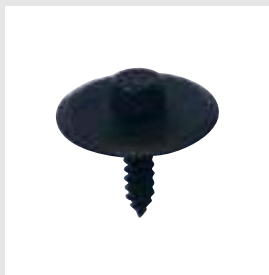

Art. No. 0501 104 054
Orig. No.: 2019900536
Fig. No.: 37



Art. No. 0501 104 051
Orig. No.: A0039900251
Fig. No.: 38



Art. No. 0501 104 050
Orig. No.: A2019900050
Fig. No.: 39

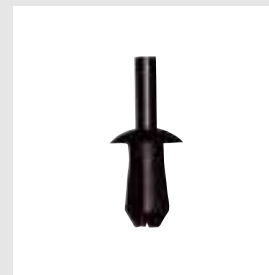

Art. No. 0500 523 14
Orig. No.: A0009903492
Fig. No.: 40



Art. No. 0500 124 28
Orig. No.: 0009900392
0009902292
Fig. No.: 41



Art. No. 0501 103 035
Orig. No.: A0009905592
Fig. No.: 42



Art. No. 0500 937 7
Orig. No.:
Fig. No.: 43



Art. No. 0500 919 2
Orig. No.: 1239900092
Fig. No.: 44



Art. No. 0500 40
Orig. No.: 1239900292
Eurocode: 6539ASSHB
Fig. No.: 45



Art. No. 0501 101 000
Orig. No.: A0009902992
Fig. No.: 46



Art. No. 0500 201 404
Orig. No.: A2019900292
A2019900292/9051
Fig. No.: 47



Art. No. 0501 104 038
Orig. No.: 0009903792
Fig. No.: 48



Art. No. 0501 103 068
Orig. No.: A0019901692
Fig. No.: 49



Art. No. 0501 104 070
Orig. No.: A2309900192
Fig. No.: 50



Art. No. 0501 104 071
Orig. No.: A1249900092
Fig. No.: 51



Art. No. 0501 104 084
Orig. No.: A0009908492
Fig. No.: 52



Art. No. 0501 104 122
Orig. No.: A0019944145
Fig. No.: 53



Art. No. 0501 105 064
Orig. No.: A0009905492
A0009905492 / 9051
Fig. No.: 54



Art. No. 0501 121 120
Orig. No.: A0019901392
Fig. No.: 55



Art. No. 0500 123 23
Orig. No.: 0009871015
Fig. No.: 56

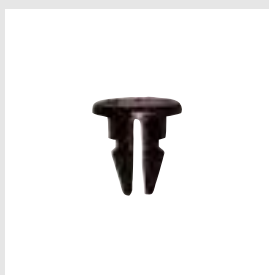

Art. No. 0501 104 072
Orig. No.: A0009908792
Fig. No.: 57



Art. No. 0501 104 073
Orig. No.: A0019951965
Fig. No.: 58

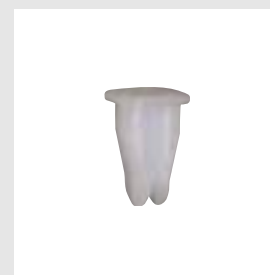

Art. No. 0501 104 117
Orig. No.: 0009881625
6399880185
Fig. No.: 59



Art. No. 0500 123 76
Orig. No.: 0009885581
Fig. No.: 60



Art. No. 0500 117 07
Orig. No.: 0009880027
Fig. No.: 61



Art. No. 0500 150 21
Orig. No.: 0019882081
Fig. No.: 62



Art. No. 0500 600 14
Orig. No.: A2019972281
Fig. No.: 63

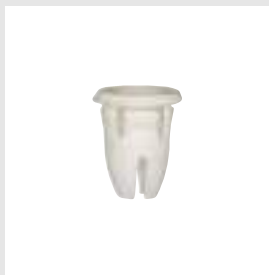

Art. No. 0501 104 035
Orig. No.: A0019887681
Fig. No.: 64



Art. No. 0500 136 88
Orig. No.: A0039884178
Fig. No.: 65



Art. No. 0501 104 046
Orig. No.: A0059888278
Fig. No.: 66



Art. No. 0501 104 032
Orig. No.: 0019884681
Fig. No.: 67



Art. No. 0501 104 045
Orig. No.: 0089880978
Fig. No.: 68



Art. No. 0501 104 107
Orig. No.: A0007270046
Fig. No.: 69



Art. No. 0501 104 108
Orig. No.: 0079889978
Fig. No.: 70



Art. No. 0501 104 074
Orig. No.: A0019881081
Fig. No.: 71



Art. No. 0501 104 075
Orig. No.: A0019880981
Fig. No.: 72



Art. No. 0500 405 0
Orig. No.: 0069884378
Fig. No.: 73



Art. No. 0501 104 085
Orig. No.: A4639880278
Fig. No.: 74



Art. No. 0501 304 001
Orig. No.: 2016980660
Eurocode: 5328ASCST1B
Fig. No.: 75



Art. No. 0501 304 002
Orig. No.: 2016980160
Eurocode: 5328ASCST
Fig. No.: 76



Art. No. 0501 304 006
Orig. No.: A0119889478
Eurocode: 5347ASCST
Fig. No.: 77



Art. No. 0501 104 110
Orig. No.: 0009902192
Fig. No.: 78



Art. No. 0500 142 94
Orig. No.: 0069883078
Fig. No.: 79



Art. No. 0501 104 076
Orig. No.: A0059888078
Fig. No.: 80



Art. No. 0501 104 077
Orig. No.: A0019883381
Fig. No.: 81



Art. No. 0501 104 078
Orig. No.: A0019883281
Fig. No.: 82



Art. No. 0501 104 079
Orig. No.: A0019883081
Fig. No.: 83



Art. No. 0501 104 031
Orig. No.: 0019884981
Fig. No.: 84



Art. No. 0501 104 027
Orig. No.: 0069883578
Fig. No.: 85



Art. No. 0501 104 023
Orig. No.: 0019885181
Fig. No.: 86



Art. No. 0501 104 059
Orig. No.: 0019885081
Fig. No.: 87



Art. No. 0501 104 026
Orig. No.: 0069887278
Fig. No.: 88



Art. No. 0501 104 060
Orig. No.: A0019883181
Fig. No.: 89

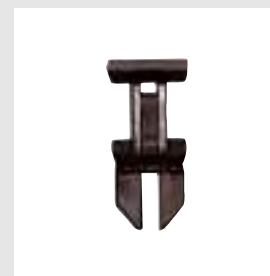

Art. No. 0501 104 201
Orig. No.: A1249900792
Fig. No.: 90



Art. No. 0501 104 080
Orig. No.: 0069888978
Fig. No.: 91



Art. No. 0501 304 004
Orig. No.: A0009915871
Eurocode: 5358ASCHDS
Fig. No.: 92



Art. No. 0501 104 086
 Orig. No.: A0099880378
 Fig. No.: 93



Art. No. 0501 104 087
 Orig. No.: A0019889781
 Fig. No.: 94

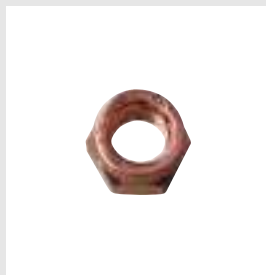

Art. No. 0366 2
 Orig. No.: A0009903250
 Fig. No.: 95

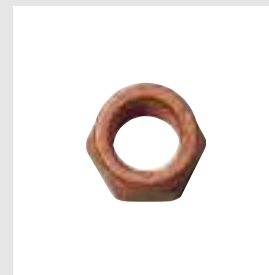

Art. No. 0366 3
 Orig. No.: 0009903150
 N999901010000
 Fig. No.: 96

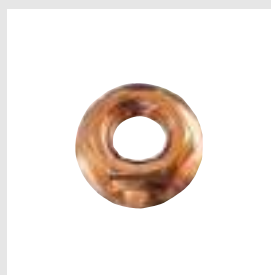

Art. No. 0365 8
 Orig. No.: A1201420072
 Fig. No.: 97



Art. No. 0501 104 118
 Orig. No.: 0019949845
 Fig. No.: 98



Art. No. 0500 135 820
 Orig. No.: A0009904892
 Fig. No.: 99

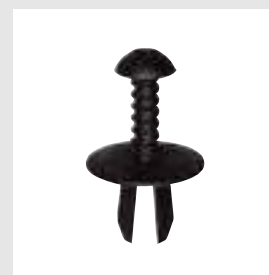

Art. No. 0501 104 039
 Orig. No.: 1269900392
 A1239900592
 Fig. No.: 100



Art. No. 0500 295 6
 Orig. No.: 0009904692
 Fig. No.: 101

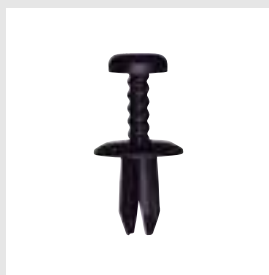

Art. No. 0500 941 2
 Orig. No.: 0009904092
 A1249900592/9051
 Fig. No.: 102

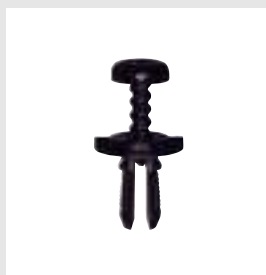

Art. No. 0500 290 1
 Orig. No.: 0009904492
 Fig. No.: 103



Art. No. 0501 304 005
 Orig. No.: A6389840861
 Eurocode: 5428ASCVL
 Fig. No.: 104



Art. No. 0501 304 003
 Orig. No.: A6389840961
 Eurocode: 5428ASCVS
 Fig. No.: 105

Index sorted by Art. No.						
Art. No.	Orig. No.	Eurocode	Designation	Car type	Fig.	P. Qty.
0129 986 020	914007006014		COMBINATION SCREW M6X20 DIN 933 WASHER 1.6X1 8 GALV.*	UNIVERSAL	36	50
0365 8	A1201420072		SELF-LOCKING FLANGED NUT M 8 12 MM CU COAT.*	-	97	100
0366 2	A0009903250		SLOTTED NUT 14441 M 8 x 1.25 12 MM CU COAT. 6MY *	-	95	50
0366 3	0009903150		SLOTTED NUT 14441 M 10 x 1.5 14 MM CU COAT. 6MY*	-	96	50
0366 3	N999901010000		SLOTTED NUT 14441 M 10 x 1.5 14 MM CU COAT. 6MY*	-	96	50
0500 111 82	A0009940145		SPRING NUT 4.0 MM GALV. CLR. PASSIV.	UNIVERSAL	33	100
0500 113 17	0009881878		CABLE CLAMP GALV. CLR. PASSIV.	-	35	25
0500 113 62	1409941045		SHEET-METAL NUT ST 4.2 MM GALV. CLR. PASSIV.	VARIOUS MODELS	6	100
0500 113 69	0009945045		SHEET-METAL NUT ST 6.3 MM GALV. CLR. PASSIV. MATT	UNIVERSAL	9	100
0500 114 04	0009940845		SHEET-METAL NUT ST 6.3 MM GALV. CLR. PASSIV. MATT	UNIVERSAL	10	100
0500 114 27	0009940945		SHEET-METAL NUT ST 6.3 MM GALV.	VARIOUS MODELS	15	100
0500 114 70	0009941445		SHEET-METAL NUT ST 4.8 MM GALV.	VARIOUS MODELS	11	50
0500 115 22			SHEET-METAL NUT ST 4.8 MM GALV. CLR. PASSIV.	UNIVERSAL	8	100
0500 116 67	0009942345		SHEET-METAL NUT ST 4.2 MM GALV. CLR. PASSIV.	UNIVERSAL	12	100
0500 117 07	0009880027		GROMMET FOR LETTERING PE 181 CLR.	UNIVERSAL	61	100
0500 117 45	0009942545		SHEET-METAL NUT ST 4.2 MM GALV. CLR. PASSIV.	UNIVERSAL	7	100
0500 119 56	A0009944245		SHEET-METAL NUT ST 2.9 MM GALV. CLR. PASSIV.	-	5	100
0500 121 98	A0009944745		SHEET-METAL NUT ST 5.5 MM GALV. CLR. PASSIV.	UNIVERSAL	13	100
0500 123 23	0009871015		PLASTIC RIVET WITHOUT PIN PA 601 COLORLESS	UNIVERSAL	56	25
0500 123 76	0009885581		BLUE GROMMET	108	60	100
0500 124 28	0009900392		PLASTIC SPLIT RIVET PA 122 BLACK *	UNIVERSAL	41	50
0500 124 28	0009902292		PLASTIC SPLIT RIVET PA 122 BLACK *	UNIVERSAL	41	50
0500 124 63	1149970290		CABLE TIE PA 12 BLACK WITH RIVET 160 MM	UNIVERSAL	31	50
0500 124 63	1149970590		CABLE TIE PA 12 BLACK WITH RIVET 160 MM	UNIVERSAL	31	50
0500 125 28	0019974390		CABLE TIE 250 x 14 MM PA 12 BLACK	UNIVERSAL	32	50
0500 131 33	1239940045		SHEET-METAL NUT ST 4.8 MM GALV. CLR. PASSIV.	UNIVERSAL	16	100
0500 131 74	1239940145		SHEET-METAL NUT ST 2.9 MM GALV. CLR. PASSIV.	UNIVERSAL	14	100
0500 132 19	A1239940645		SHEET-METAL NUT ST 4.8 MM GALV. CLR. PASSIV.	UNIVERSAL	20	100
0500 132 300	A0019971386		FIR-TREE CLIP PE BLACK	W108, W109, W110, W11, W114, W115, W116, W140, W461	3	50
0500 132 300	A0009974886		FIR-TREE CLIP PE BLACK	W108, W109, W110, W11, W114, W115, W116, W140, W461	3	50
0500 132 51	1239940845		SHEET-METAL NUT ST 4.2 MM GALV. CLR. PASSIV.	UNIVERSAL	22	100
0500 133 84	A0009940645		SHEET-METAL NUT ST 4.8 MM GALV. CLR. PASSIV.	-	26	100
0500 135 820	A0009904892		THREADED BLIND RIVET PA 66 BLACK	W116, 123, W126, R129, 170, W203, OM444, OM636, W639, SPRINTER	99	50
0500 136 37	1239941545		SHEET-METAL NUT ST 5.5 MM MET. CORR. PROT. 3.0 SI	UNIVERSAL	19	100
0500 136 88	A0039884178		INTERIOR LINING CLIP POM COLORLESS	W210	65	100
0500 142 94	0069883078		TRIM CLIP PA 120 COLORLESS	UNIVERSAL	79	50
0500 150 21	0019882081		GROMMET FOR TRIM CLIP PA 601 RED	UNIVERSAL	62	50
0500 201 404	A2019900292		PLASTIC SPLIT RIVET PA 6 BLACK	UNIVERSAL	47	25
0500 201 404	A2019900292/9051		PLASTIC SPLIT RIVET PA 6 BLACK	UNIVERSAL	47	25

Index sorted by Art. No.						
Art. No.	Orig. No.	Eurocode	Designation	Car type	Fig.	P. Qty.
0500 290 1	0009904492		THREADED BLIND RIVET SQUARE PA 66 BLACK	UNIVERSAL	103	25
0500 295 6	0009904692		THREADED BLIND RIVET PA 6.6 BLACK	UNIVERSAL	101	25
0500 40	1239900292	6539ASSHB	PLASTIC SPLIT RIVET FOR LUGGAGE COMPARTMENT LINING PA 6 BLACK	UNIVERSAL	45	50
0500 405 0	0069884378		INTERIOR LINING CLIP POM COLORLESS	VARIOUS MODELS	73	100
0500 523 14	A0009903492		PLASTIC SPLIT RIVET PA12 BLACK	UNIVERSAL	40	50
0500 595 0	A0019900091		SHEET-METAL NUT M 6 GALV. CLR. PASSIV.	SL, W124, W126, SPRINTER	21	25
0500 600 14	A2019972281		COLORLESS GROMMET	UNIVERSAL	63	100
0500 919 2	1239900092		PLASTIC SPLIT RIVET WITH CAP DARK GRAY	UNIVERSAL	44	50
0500 937 7			PLASTIC SPLIT RIVET PA 66 DARK GRAY	UNIVERSAL, OLD	43	100
0500 939 6	A0009912895		FIR-TREE CLIP PA66 BLACK	-	2	25
0500 941 2	0009904092		THREADED BLIND RIVET PA 66 BLACK	UNIVERSAL	102	25
0500 941 2	A1249900592/9051		THREADED BLIND RIVET PA 66 BLACK	UNIVERSAL	102	25
0501 101 000	A0009902992		PLASTIC SPLIT RIVET PA66 BK	VARIOUS MODELS	46	100
0501 102 005	A0039941545		SHEET-METAL NUT M 8 GALV. CLR. PASSIV.	-	24	100
0501 102 026	A0019905891		SHEET-METAL NUT M 8 GALV. CLR. PASSIV. SELF-LOCKING	-	25	10
0501 103 035	A0009905592		PLASTIC SPLIT RIVET PA 661 BLACK	UNIVERSAL	42	25
0501 103 068	A0019901692		PLASTIC SPLIT RIVET PA 661 BLACK*	-	49	50
0501 104 023	0019885181		TRIM CLIP FENDER LINING POM 550 COLORLESS	W 124 FROM 9/89	86	50
0501 104 026	0069887278		TRIM CLIP POM 500 COLORLESS	W124	88	25
0501 104 027	0069883578		TRIM CLIP POM 500 COLORLESS	190	85	25
0501 104 031	0019884981		TRIM CLIP FOR FENDER LINING POM 009 COLORLESS	W124	84	50
0501 104 032	0019884681		INTERIOR LINING CLIP FOR DOOR POM COLORLESS	W 201 FROM 9/89	67	25
0501 104 035	A0019887681		GROMMET FOR TRIM CLIP PBT HI 460 WHITE	W202, W203	64	25
0501 104 038	0009903792		PLASTIC SPLIT RIVET BK UNDERRIDE GUARD FASTENER PA122	W 123, TRUCK	48	50
0501 104 039	1269900392		THREADED BLIND RIVET FOR WHEEL INSTAL. PARTI. WALL	W 123, 124, 201, 140, 126	100	50
0501 104 039	A1239900592		THREADED BLIND RIVET FOR WHEEL INSTAL. PARTI. WALL	W 123, 124, 201, 140, 126	100	50
0501 104 045	0089880978		INTERIOR LINING CLIP FOR DOOR POM NATURAL	LORRIES	68	50
0501 104 046	A0059888278		INTERIOR LINING CLIP POM COLORLESS	TRUCK FROM 89	66	50
0501 104 048	0019979586		JACK RECEPTACLE DB	W 124 FROM 9/89	4	6
0501 104 050	A2019900050		PLASTIC NUT WHEEL INSTAL. PARTI. WALL PA 6 GF 30 BLACK	W211, W203, W169, W245	39	100
0501 104 051	A0039900251		PLASTIC NUT TUNNEL COVER	W245	38	100
0501 104 054	2019900536		COMBINATION SCREW ST. 4.8x19 DIN 7976 VZSO *	UNIVERSAL	37	25
0501 104 059	0019885081		TRIM CLIP POM 550 COLORLESS	UNIVERSAL	87	25
0501 104 060	A0019883181		TRIM CLIP POM 009 COLORLESS	UNIVERSAL	89	25
0501 104 064	A0019945445		SHEET-METAL NUT ST 2.9 MM GALV. CLR. PASSIV.	-	17	100
0501 104 065	A0019946945		SHEET-METAL NUT ST4.2 MET. CORR. PROT. 2.1 SI	-	27	100
0501 104 066	A0029948045		SHEET-METAL NUT ST 4.8 ZN MET. CORR. PROT. 10.2 SI	-	28	100
0501 104 067	A0049940645		SHEET-METAL NUT ST 4.8 MET. CORR. PROT. 2.0 SI	W169, W245	29	100
0501 104 067	A0039948645		SHEET-METAL NUT ST 4.8 MET. CORR. PROT. 2.0 SI	W169, W245	29	100
0501 104 068	A0039948945		SHEET-METAL NUT ST 4.8 MET. CORR. PROT. 2.0 SI	-	30	100
0501 104 069	A1299950065		ROD RETAINER POM BK	-	34	100

Index sorted by Art. No.						
Art. No.	Orig. No.	Eurocode	Designation	Car type	Fig.	P. Qty.
0501 104 070	A2309900192		GRAY PLASTIC SPLIT RIVET	SLK	50	100
0501 104 071	A1249900092		PLASTIC SPLIT RIVET PA 6 BLACK	-	51	100
0501 104 072	A0009908792		PLASTIC RIVET WITHOUT PIN BLACK*	-	57	100
0501 104 073	A0019951965		ROTATING CABLE HOLDER POM BLACK	-	58	100
0501 104 074	A0019881081		INTERIOR LINING CLIP LOWER SECTION POM WHITE	-	71	100
0501 104 075	A0019880981		INTERIOR LINING CLIP UPPER SECTION POM WHITE	-	72	100
0501 104 076	A0059888078		TRIM CLIP POM 550 COLORLESS	-	80	100
0501 104 077	A0019883381		TRIM CLIP POM 500 COLORLESS	-	81	25
0501 104 078	A0019883281		TRIM CLIP POM 130 COLORLESS	200, 220, 230, 300, 320	82	100
0501 104 079	A0019883081		TRIM CLIP PA 620 BLACK	-	83	100
0501 104 080	0069888978		TRIM CLIP POM COLORLESS WAXED	VARIOUS MODELS	91	50
0501 104 084	A0009908492		PLASTIC SPLIT RIVET BLACK PA 6.6	W203	52	50
0501 104 085	A4639880278		INTERIOR LINING CLIP POM BLACK	240, 270, 320	74	10
0501 104 086	A0099880378		TRIM CLIP POM + GROMMET PBT COLORLESS	-	93	25
0501 104 087	A0019889781		TRIM CLIP POM COLORLESS	-	94	25
0501 104 105	A0009974686		FIR-TREE CLIP PE BLACK	-	1	50
0501 104 107	A0007270046		INTERIOR LINING CLIP POM GREEN	-	69	50
0501 104 108	0079889978		INTERIOR LINING CLIP LIGHT GREEN	-	70	25
0501 104 110	0009902192		COLORLESS TRIM CLIP	UNIVERSAL	78	50
0501 104 117	0009881625		COLORLESS EXPANDING NUT	201	59	100
0501 104 117	6399880185		COLORLESS EXPANDING NUT	201	59	100
0501 104 118	0019949845		PRESTOLE CAGE NUT FOR ENGINE COMP. LINING MET. CORR. PROT. SI	W 124, 201	98	25
0501 104 119	A0039941745		SHEET-METAL NUT M 6 GALV. CLR. PASSIV.	-	18	100
0501 104 120	A0029942045		SHEET-METAL NUT M 5 MET. CORR. PROT. 2.2 BK	-	23	100
0501 104 122	A0019944145		PLASTIC SPLIT RIVET PA 66 BLACK	-	53	100
0501 104 201	A1249900792		TRIM CLIP FOR TRUNK LID PA 66 BLACK	W124, W203, W245	90	100
0501 105 064	A0009905492		PLASTIC SPLIT RIVET FOR BUMPER PA 66 BLACK	W203, W211	54	50
0501 105 064	A0009905492 / 9051		PLASTIC SPLIT RIVET FOR BUMPER PA 66 BLACK	W203, W211	54	50
0501 121 120	A0019901392		PLASTIC SPLIT RIVET POM BK	-	55	25
0501 304 001	2016980660	5328ASCST1B	ROOF TRIM CLIP	190, 202	75	25
0501 304 002	2016980160	5328ASCST	WEATHER STRIP CLIP	190, 192	76	25
0501 304 003	A6389840961	5428ASCVS	BLACK CLIP	-	105	25
0501 304 004	A0009915871	5358ASCHDS	ROOF TRIM CLIP POM BLACK	W169, W245	92	25
0501 304 005	A6389840861	5428ASCVL	COLORLESS CLIP	-	104	25
0501 304 006	A0119889478	5347ASCS	BLACK ROOF RAIL CLIP + U-CLIP MET. CORR. PROT. SI	W211	77	25

Index sorted by Orig. No.						
Orig. No.	Art. No.	Eurocode	Designation	Car type	Fig.	P. Qty.
	0500 115 22		SHEET-METAL NUT ST 4.8 MM GALV. CLR. PASSIV.	UNIVERSAL	8	100
0009871015	0500 123 23		PLASTIC RIVET WITHOUT PIN PA 601 COLORLESS	UNIVERSAL	56	25
0009880027	0500 117 07		GROMMET FOR LETTERING PE 181 CLR.	UNIVERSAL	61	100
0009881625	0501 104 117		COLORLESS EXPANDING NUT	201	59	100
6399880185	0501 104 117		COLORLESS EXPANDING NUT	201	59	100
0009881878	0500 113 17		CABLE CLAMP GALV. CLR. PASSIV.	-	35	25
0009885581	0500 123 76		BLUE GROMMET	108	60	100
0009900392	0500 124 28		PLASTIC SPLIT RIVET PA 122 BLACK *	UNIVERSAL	41	50
0009902292	0500 124 28		PLASTIC SPLIT RIVET PA 122 BLACK *	UNIVERSAL	41	50
0009902192	0501 104 110		COLORLESS TRIM CLIP	UNIVERSAL	78	50
0009903150	0366 3		SLOTTED NUT 14441 M 10 x 1.5 14 MM CU COAT. 6MY*	-	96	50
N999901010000	0366 3		SLOTTED NUT 14441 M 10 x 1.5 14 MM CU COAT. 6MY*	-	96	50
0009903792	0501 104 038		PLASTIC SPLIT RIVET BK UNDERRIDE GUARD FASTENER PA122	W 123, TRUCK	48	50
0009904092	0500 941 2		THREADED BLIND RIVET PA 66 BLACK	UNIVERSAL	102	25
A1249900592/9051	0500 941 2		THREADED BLIND RIVET PA 66 BLACK	UNIVERSAL	102	25
0009904492	0500 290 1		THREADED BLIND RIVET SQUARE PA 66 BLACK	UNIVERSAL	103	25
0009904692	0500 295 6		THREADED BLIND RIVET PA 6.6 BLACK	UNIVERSAL	101	25
0009940845	0500 114 04		SHEET-METAL NUT ST 6.3 MM GALV. CLR. PASSIV. MATT	UNIVERSAL	10	100
0009940945	0500 114 27		SHEET-METAL NUT ST 6.3 MM GALV.	VARIOUS MODELS	15	100
0009941445	0500 114 70		SHEET-METAL NUT ST 4.8 MM GALV.	VARIOUS MODELS	11	50
0009942345	0500 116 67		SHEET-METAL NUT ST 4.2 MM GALV. CLR. PASSIV.	UNIVERSAL	12	100
0009942545	0500 117 45		SHEET-METAL NUT ST 4.2 MM GALV. CLR. PASSIV.	UNIVERSAL	7	100
0009945045	0500 113 69		SHEET-METAL NUT ST 6.3 MM GALV. CLR. PASSIV. MATT	UNIVERSAL	9	100
0019882081	0500 150 21		GROMMET FOR TRIM CLIP PA 601 RED	UNIVERSAL	62	50
0019884681	0501 104 032		INTERIOR LINING CLIP FOR DOOR POM COLORLESS	W 201 FROM 9/89	67	25
0019884981	0501 104 031		TRIM CLIP FOR FENDER LINING POM 009 COLORLESS	W124	84	50
0019885081	0501 104 059		TRIM CLIP POM 550 COLORLESS	UNIVERSAL	87	25
0019885181	0501 104 023		TRIM CLIP FENDER LINING POM 550 COLORLESS	W 124 FROM 9/89	86	50
0019949845	0501 104 118		PRESTOLE CAGE NUT FOR ENGINE COMP. LINING MET. CORR. PROT. SI	W 124, 201	98	25
0019974390	0500 125 28		CABLE TIE 250 x 14 MM PA 12 BLACK	UNIVERSAL	32	50
0019979586	0501 104 048		JACK RECEPTACLE DB	W 124 FROM 9/89	4	6
0069883078	0500 142 94		TRIM CLIP PA 120 COLORLESS	UNIVERSAL	79	50
0069883578	0501 104 027		TRIM CLIP POM 500 COLORLESS	190	85	25
0069884378	0500 405 0		INTERIOR LINING CLIP POM COLORLESS	VARIOUS MODELS	73	100
0069887278	0501 104 026		TRIM CLIP POM 500 COLORLESS	W124	88	25
0069888978	0501 104 080		TRIM CLIP POM COLORLESS WAXED	VARIOUS MODELS	91	50
0079889978	0501 104 108		INTERIOR LINING CLIP LIGHT GREEN	-	70	25
0089880978	0501 104 045		INTERIOR LINING CLIP FOR DOOR POM NATURAL	LORRIES	68	50
1149970290	0500 124 63		CABLE TIE PA 12 BLACK WITH RIVET 160 MM	UNIVERSAL	31	50
1149970590	0500 124 63		CABLE TIE PA 12 BLACK WITH RIVET 160 MM	UNIVERSAL	31	50

Index sorted by Orig. No.						
Orig. No.	Art. No.	Eurocode	Designation	Car type	Fig.	P. Qty.
1239900092	0500 919 2		PLASTIC SPLIT RIVET WITH CAP DARK GRAY	UNIVERSAL	44	50
1239900292	0500 40	6539ASSHB	PLASTIC SPLIT RIVET FOR LUGGAGE COMPARTMENT LINING PA 6 BLACK	UNIVERSAL	45	50
1239940045	0500 131 33		SHEET-METAL NUT ST 4.8 MM GALV. CLR. PASSIV.	UNIVERSAL	16	100
1239940145	0500 131 74		SHEET-METAL NUT ST 2.9 MM GALV. CLR. PASSIV.	UNIVERSAL	14	100
1239940845	0500 132 51		SHEET-METAL NUT ST 4.2 MM GALV. CLR. PASSIV.	UNIVERSAL	22	100
1239941545	0500 136 37		SHEET-METAL NUT ST 5.5 MM MET. CORR. PROT. 3.0 SI	UNIVERSAL	19	100
1269900392	0501 104 039		THREADED BLIND RIVET FOR WHEEL INSTAL. PARTI. WALL	W 123, 124, 201, 140, 126	100	50
A1239900592	0501 104 039		THREADED BLIND RIVET FOR WHEEL INSTAL. PARTI. WALL	W 123, 124, 201, 140, 126	100	50
1409941045	0500 113 62		SHEET-METAL NUT ST 4.2 MM GALV. CLR. PASSIV.	VARIOUS MODELS	6	100
2016980160	0501 304 002	5328ASCST	WEATHER STRIP CLIP	190, 192	76	25
2016980660	0501 304 001	5328ASCST1B	ROOF TRIM CLIP	190, 202	75	25
2019900536	0501 104 054		COMBINATION SCREW ST. 4.8x19 DIN 7976 VZSO *	UNIVERSAL	37	25
914007006014	0129 986 020		COMBINATION SCREW M6X20 DIN 933 WASHER 1.6X1 8 GALV.*	UNIVERSAL	36	50
A0007270046	0501 104 107		INTERIOR LINING CLIP POM GREEN	-	69	50
A0009902992	0501 101 000		PLASTIC SPLIT RIVET PA66 BK	VARIOUS MODELS	46	100
A0009903250	0366 2		SLOTTED NUT 14441 M 8 x 1.25 12 MM CU COAT. 6MY *	-	95	50
A0009903492	0500 523 14		PLASTIC SPLIT RIVET PA12 BLACK	UNIVERSAL	40	50
A0009904892	0500 135 820		THREADED BLIND RIVET PA 66 BLACK	W116, 123, W126, R129, 170, W203, OM444, OM636, W639, SPRINTER	99	50
A0009905492	0501 105 064		PLASTIC SPLIT RIVET FOR BUMPER PA 66 BLACK	W203, W211	54	50
A0009905492 / 9051	0501 105 064		PLASTIC SPLIT RIVET FOR BUMPER PA 66 BLACK	W203, W211	54	50
A0009905592	0501 103 035		PLASTIC SPLIT RIVET PA 661 BLACK	UNIVERSAL	42	25
A0009908492	0501 104 084		PLASTIC SPLIT RIVET BLACK PA 6.6	W203	52	50
A0009908792	0501 104 072		PLASTIC RIVET WITHOUT PIN BLACK*	-	57	100
A0009912895	0500 939 6		FIR-TREE CLIP PA66 BLACK	-	2	25
A0009915871	0501 304 004	5358ASCHDS	ROOF TRIM CLIP POM BLACK	W169, W245	92	25
A0009940145	0500 111 82		SPRING NUT 4.0 MM GALV. CLR. PASSIV.	UNIVERSAL	33	100
A0009940645	0500 133 84		SHEET-METAL NUT ST 4.8 MM GALV. CLR. PASSIV.	-	26	100
A0009944245	0500 119 56		SHEET-METAL NUT ST 2.9 MM GALV. CLR. PASSIV.	-	5	100
A0009944745	0500 121 98		SHEET-METAL NUT ST 5.5 MM GALV. CLR. PASSIV.	UNIVERSAL	13	100
A0009974686	0501 104 105		FIR-TREE CLIP PE BLACK	-	1	50
A0019880981	0501 104 075		INTERIOR LINING CLIP UPPER SECTION POM WHITE	-	72	100
A0019881081	0501 104 074		INTERIOR LINING CLIP LOWER SECTION POM WHITE	-	71	100
A0019883081	0501 104 079		TRIM CLIP PA 620 BLACK	-	83	100
A0019883181	0501 104 060		TRIM CLIP POM 009 COLORLESS	UNIVERSAL	89	25
A0019883281	0501 104 078		TRIM CLIP POM 130 COLORLESS	200, 220, 230, 300, 320	82	100
A0019883381	0501 104 077		TRIM CLIP POM 500 COLORLESS	-	81	25
A0019887681	0501 104 035		GROMMET FOR TRIM CLIP PBT HI 460 WHITE	W202, W203	64	25
A0019889781	0501 104 087		TRIM CLIP POM COLORLESS	-	94	25

Index sorted by Orig. No.						
Orig. No.	Art. No.	Eurocode	Designation	Car type	Fig.	P. Qty.
A0019900091	0500 595 0		SHEET-METAL NUT M 6 GALV. CLR. PASSIV.	SL, W124, W126, SPRINTER	21	25
A0019901392	0501 121 120		PLASTIC SPLIT RIVET POM BK	-	55	25
A0019901692	0501 103 068		PLASTIC SPLIT RIVET PA 661 BLACK*	-	49	50
A0019905891	0501 102 026		SHEET-METAL NUT M 8 GALV. CLR. PASSIV. SELF-LOCKING	-	25	10
A0019944145	0501 104 122		PLASTIC SPLIT RIVET PA 66 BLACK	-	53	100
A0019945445	0501 104 064		SHEET-METAL NUT ST 2.9 MM GALV. CLR. PASSIV.	-	17	100
A0019946945	0501 104 065		SHEET-METAL NUT ST4.2 MET. CORR. PROT. 2.1 SI	-	27	100
A0019951965	0501 104 073		ROTATING CABLE HOLDER POM BLACK	-	58	100
A0019971386	0500 132 300		FIR-TREE CLIP PE BLACK	W108, W109, W110, W11, W114, W115, W116, W140, W461	3	50
A0009974886	0500 132 300		FIR-TREE CLIP PE BLACK	W108, W109, W110, W11, W114, W115, W116, W140, W461	3	50
A0029942045	0501 104 120		SHEET-METAL NUT M 5 MET. CORR. PROT. 2.2 BK	-	23	100
A0029948045	0501 104 066		SHEET-METAL NUT ST 4.8 ZN MET. CORR. PROT. 10.2 SI	-	28	100
A0039884178	0500 136 88		INTERIOR LINING CLIP POM COLORLESS	W210	65	100
A0039900251	0501 104 051		PLASTIC NUT TUNNEL COVER	W245	38	100
A0039941545	0501 102 005		SHEET-METAL NUT M 8 GALV. CLR. PASSIV.	-	24	100
A0039941745	0501 104 119		SHEET-METAL NUT M 6 GALV. CLR. PASSIV.	-	18	100
A0039948945	0501 104 068		SHEET-METAL NUT ST 4.8 MET. CORR. PROT. 2.0 SI	-	30	100
A0049940645	0501 104 067		SHEET-METAL NUT ST 4.8 MET. CORR. PROT. 2.0 SI	W169, W245	29	100
A0039948645	0501 104 067		SHEET-METAL NUT ST 4.8 MET. CORR. PROT. 2.0 SI	W169, W245	29	100
A0059888078	0501 104 076		TRIM CLIP POM 550 COLORLESS	-	80	100
A0059888278	0501 104 046		INTERIOR LINING CLIP POM COLORLESS	TRUCK FROM 89	66	50
A0099880378	0501 104 086		TRIM CLIP POM + GROMMET PBT COLORLESS	-	93	25
A0119889478	0501 304 006	5347ASCS	BLACK ROOF RAIL CLIP + U-CLIP MET. CORR. PROT. SI	W211	77	25
A1201420072	0365 8		SELF-LOCKING FLANGED NUT M 8 12 MM CU COAT.*	-	97	100
A1239940645	0500 132 19		SHEET-METAL NUT ST 4.8 MM GALV. CLR. PASSIV.	UNIVERSAL	20	100
A1249900092	0501 104 071		PLASTIC SPLIT RIVET PA 6 BLACK	-	51	100
A1249900792	0501 104 201		TRIM CLIP FOR TRUNK LID PA 66 BLACK	W124, W203, W245	90	100
A1299950065	0501 104 069		ROD RETAINER POM BK	-	34	100
A2019900050	0501 104 050		PLASTIC NUT WHEEL INSTAL. PARTI. WALL PA 6 GF 30 BLACK	W211, W203, W169, W245	39	100
A2019900292	0500 201 404		PLASTIC SPLIT RIVET PA 6 BLACK	UNIVERSAL	47	25
A2019900292/9051	0500 201 404		PLASTIC SPLIT RIVET PA 6 BLACK	UNIVERSAL	47	25
A2019972281	0500 600 14		COLORLESS GROMMET	UNIVERSAL	63	100
A2309900192	0501 104 070		GRAY PLASTIC SPLIT RIVET	SLK	50	100
A4639880278	0501 104 085		INTERIOR LINING CLIP POM BLACK	240, 270, 320	74	10
A6389840861	0501 304 005	5428ASCVL	COLORLESS CLIP	-	104	25
A6389840961	0501 304 003	5428ASCVS	BLACK CLIP	-	105	25



Art. No. 0500 201 404
 Orig. No.: M820141
 Fig. No.: 1



Art. No. 0500 405 0
 Orig. No.: M283083
 Fig. No.: 2



Art. No. 0501 133 001
 Orig. No.: MB801523
 Fig. No.: 3



Art. No. 0501 133 008
 Orig. No.: MR181745
 Fig. No.: 4



Art. No. 0362 112 15
 Orig. No.: MA103087
 Fig. No.: 5



Art. No. 0500 777 3
 Orig. No.: MB345544
 Fig. No.: 6

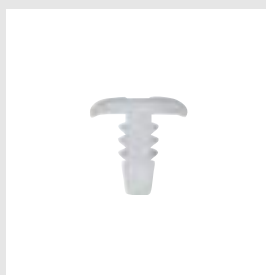

Art. No. 0501 133 009
 Orig. No.: MB105489
 Fig. No.: 7



Art. No. 0501 132 003
 Orig. No.: MR328954
 Fig. No.: 8

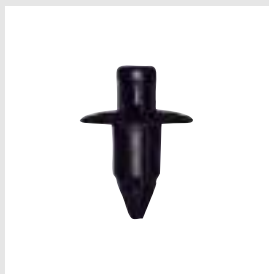

Art. No. 0501 130 010
 Orig. No.: MB476821
 Fig. No.: 9

Index sorted by Art. No.						
Art. No.	Orig. No.	Eurocode	Designation	Car type	Fig.	P. Qty.
0362 112 15	MA103087		WHEEL NUT M12x1.5 21 MM GALV. 3*	-	5	100
0500 201 404	M820141		PLASTIC SPLIT RIVET PA 6 BLACK	-	1	25
0500 405 0	M283083		INTERIOR LINING CLIP POM COLORLESS	-	2	100
0500 777 3	MB345544		BLACK THREADED BLIND RIVET TOYOTA*	-	6	25
0501 130 010	MB476821		RECURSION RIVET POM BLACK *	-	9	25
0501 132 003	MR328954		BLACK PLASTIC SPLIT RIVET*	PAJERO, GALANT, SPACE RUNNER	8	25
0501 133 001	MB801523		COLORLESS INTERIOR LINING CLIP*	-	3	100
0501 133 008	MR181745		INTERIOR LINING CLIP POM COLORLESS*	-	4	10
0501 133 009	MB105489		DOOR SEAL CLIP PA COLORLESS*	-	7	10

Index sorted by Orig. No.						
Orig. No.	Art. No.	Eurocode	Designation	Car type	Fig.	P. Qty.
M283083	0500 405 0		INTERIOR LINING CLIP POM COLORLESS	-	2	100
M820141	0500 201 404		PLASTIC SPLIT RIVET PA 6 BLACK	-	1	25
MA103087	0362 112 15		WHEEL NUT M12x1.5 21 MM GALV. 3*	-	5	100
MB105489	0501 133 009		DOOR SEAL CLIP PA COLORLESS*	-	7	10
MB345544	0500 777 3		BLACK THREADED BLIND RIVET TOYOTA*	-	6	25
MB476821	0501 130 010		RECURSION RIVET POM BLACK*	-	9	25
MB801523	0501 133 001		COLORLESS INTERIOR LINING CLIP*	-	3	100
MR181745	0501 133 008		INTERIOR LINING CLIP POM COLORLESS*	-	4	10
MR328954	0501 132 003		BLACK PLASTIC SPLIT RIVET*	PAJERO, GALANT, SPACE RUNNER	8	25

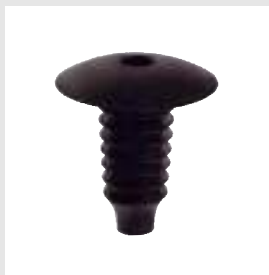

Art. No. 0501 105 601
 Orig. No.: 2207713
 90082231
 Fig. No.: 1

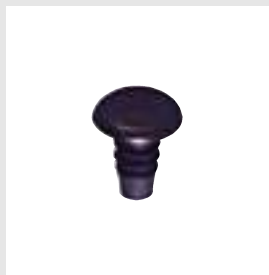

Art. No. 0500 127 09
 Orig. No.: 2240861
 90022049
 Fig. No.: 2

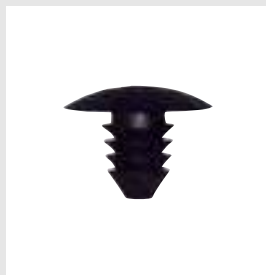

Art. No. 0501 104 105
 Orig. No.:
 Fig. No.: 3

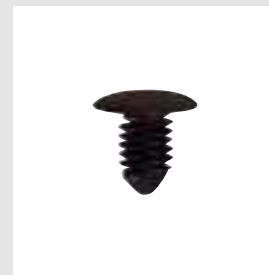

Art. No. 0500 939 6
 Orig. No.: 2344879
 90152926
 Fig. No.: 4

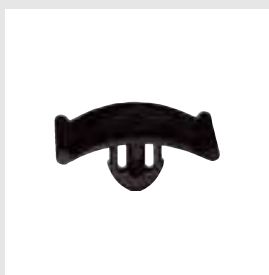

Art. No. 0501 103 043
 Orig. No.: 1162488
 90355604
 Fig. No.: 5

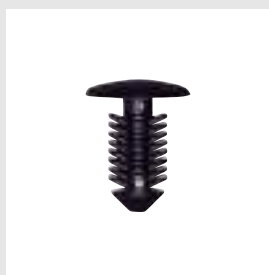

Art. No. 0500 939 5
 Orig. No.: 2338955
 90431553
 Fig. No.: 6



Art. No. 0500 402 9
 Orig. No.: 1162484
 90040750
 Fig. No.: 7

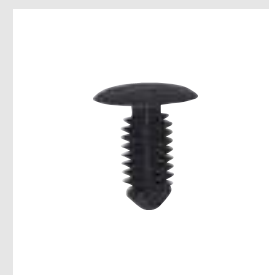

Art. No. 0501 103 073
 Orig. No.: 2346824
 90283614
 Fig. No.: 8

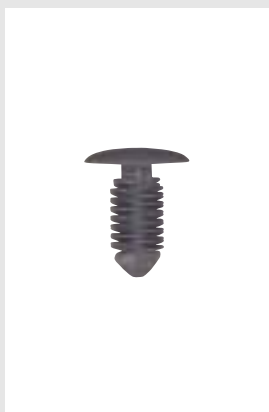

Art. No. 0501 103 077
 Orig. No.: 2226953
 90328384
 Fig. No.: 9



Art. No. 0500 133
 Orig. No.: 164361
 90033713
 Fig. No.: 10



Art. No. 0500 121 6
 Orig. No.: 2084170
 11086102
 Fig. No.: 11



Art. No. 0501 103 054
 Orig. No.: 1406528
 90589346
 Fig. No.: 12



Art. No. 0500 115 77
 Orig. No.: 2072077
 Fig. No.: 13



Art. No. 0500 113 69
 Orig. No.: 207217565
 Fig. No.: 14



Art. No. 0500 114 03
 Orig. No.: 2072151
 Fig. No.: 15



Art. No. 0500 117 61
 Orig. No.:
 Fig. No.: 16



Art. No. 0500 132 04
 Orig. No.: 2072153
 11072461
 Fig. No.: 17



Art. No. 0500 114 27
 Orig. No.: 207217563
 Fig. No.: 18



Art. No. 0501 103 020
 Orig. No.: 1406970
 90158565
 Fig. No.: 19



Art. No. 0501 103 052
 Orig. No.: 1400906
 90464538
 Fig. No.: 20



Art. No. 0501 103 063
 Orig. No.: 1235884
 24417039
 Fig. No.: 21



Art. No. 0501 303 001
 Orig. No.: 5104988
 13155024
 Eurocode: 6302ASCHB
 Fig. No.: 22



Art. No. 0501 103 036
 Orig. No.: 353900
 90305718
 Fig. No.: 23

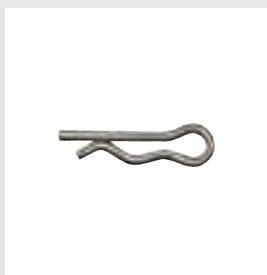

Art. No. 0500 307 71
 Orig. No.:
 Fig. No.: 24



Art. No. 0501 104 118
 Orig. No.: 850856
 90270271
 Fig. No.: 25



Art. No. 0501 106 095
 Orig. No.: 136511
 6235332
 Fig. No.: 26



Art. No. 0501 103 019

Orig. No.: 1288885

90381846

Fig. No.: 27



Art. No. 0501 103 078

Orig. No.: 1288888

90461994

Fig. No.: 28

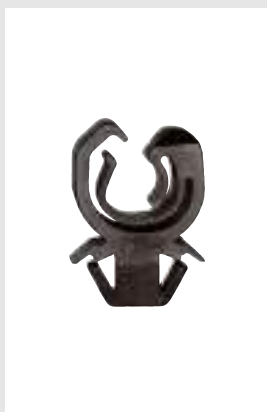

Art. No. 0501 103 064

Orig. No.: 1180216

90246867

Fig. No.: 29



Art. No. 0501 103 067

Orig. No.: 1336956

90324923

Fig. No.: 30

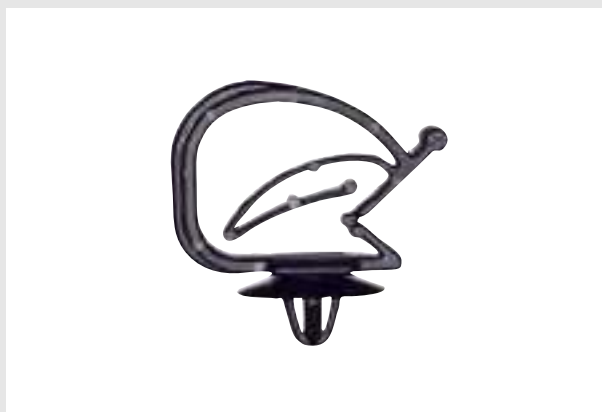

Art. No. 0501 102 001

Orig. No.: 1288548

90230571

Fig. No.: 31



Art. No. 0129 48 19
 Orig. No.: 2020005
 11071511
 Fig. No.: 32



Art. No. 0501 103 055
 Orig. No.: 2026706
 11093351
 Fig. No.: 33



Art. No. 0501 103 060
 Orig. No.: 1101412
 9287493
 Fig. No.: 34



Art. No. 0500 127 10
 Orig. No.: 1719242
 90058826
 Fig. No.: 35



Art. No. 0500 124 28
 Orig. No.: 167935
 Fig. No.: 36



Art. No. 0501 103 035
 Orig. No.: 2317703
 90116376
 Fig. No.: 37



Art. No. 0501 103 015
 Orig. No.: 1719245
 90138810
 Fig. No.: 38

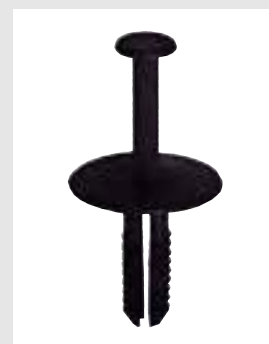

Art. No. 0501 103 017
 Orig. No.: 1400806
 90508809
 Fig. No.: 39



Art. No. 0501 101 000
 Orig. No.: 1104880
 90087290
 Fig. No.: 40



Art. No. 0501 104 038
 Orig. No.: 1104881
 90356928
 Fig. No.: 41



Art. No. 0501 103 068
 Orig. No.: 1104882
 90450482
 Fig. No.: 42



Art. No. 0501 103 065
 Orig. No.: 1406925
 9130754
 Fig. No.: 43



Art. No. 0501 103 057
 Orig. No.: 2064162
 11095121
 Fig. No.: 44



Art. No. 0501 103 071
 Orig. No.: 2208843
 90218614
 Fig. No.: 45



Art. No. 0500 134 550
 Orig. No.: 1190365
 90139015
 Fig. No.: 46



Art. No. 0500 151 97
 Orig. No.: 1216957
 90230960
 Fig. No.: 47



Art. No. 0501 103 009
 Orig. No.: 1320979
 90246677
 Fig. No.: 48



Art. No. 0501 103 010
 Orig. No.: 1406984
 90482706
 Fig. No.: 49



Art. No. 0501 103 076
 Orig. No.: 1190970
 90053803
 Fig. No.: 50

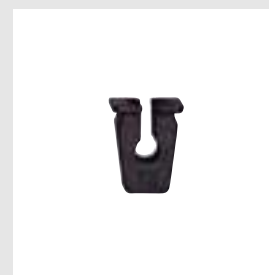

Art. No. 0500 879 33
 Orig. No.: 2240802
 90230846
 Fig. No.: 51



Art. No. 0500 117 07
 Orig. No.: 174610
 Fig. No.: 52



Art. No. 0501 103 058
 Orig. No.: 2322200
 3458462
 Fig. No.: 53

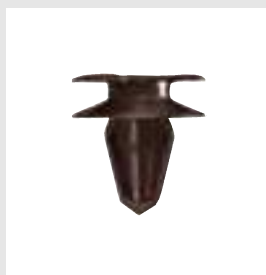

Art. No. 0500 136 31
 Orig. No.: 2240587
 2240593
 90321121
 Fig. No.: 54



Art. No. 0501 103 011
 Orig. No.: 2345957
 90321122
 Fig. No.: 55

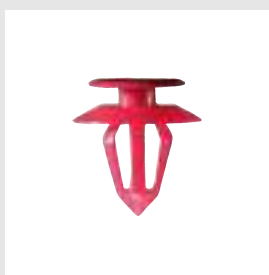

Art. No. 0501 103 012
 Orig. No.: 2345959
 90457899
 Fig. No.: 56



Art. No. 0501 103 086
 Orig. No.: 1222141
 24405740
 Fig. No.: 57



Art. No. 0501 103 087
 Orig. No.: 2228839
 24405739
 Eurocode: 6290ASCH
 Fig. No.: 58



Art. No. 0501 167 022
 Orig. No.: 4414667
 91169651
 Fig. No.: 59



Art. No. 0500 500 08
 Orig. No.: 100490
 6616858
 Fig. No.: 60



Art. No. 0501 103 085
 Orig. No.: 174854
 90481595
 Fig. No.: 61



Art. No. 0501 103 080
 Orig. No.: 174825
 Fig. No.: 62



Art. No. 0501 103 081
 Orig. No.: 174853
 90376175
 Fig. No.: 63



Art. No. 0501 103 100
 Orig. No.: 174977
 Fig. No.: 64



Art. No. 0501 103 003
 Orig. No.: 164978
 90196277
 Fig. No.: 65



Art. No. 0501 103 001
 Orig. No.: 174851
 90355565
 Fig. No.: 66



Art. No. 0501 103 101

Orig. No.: 164980
90347304
Fig. No.: 67



Art. No. 0501 103 102

Orig. No.: 171963
90460866
Fig. No.: 68

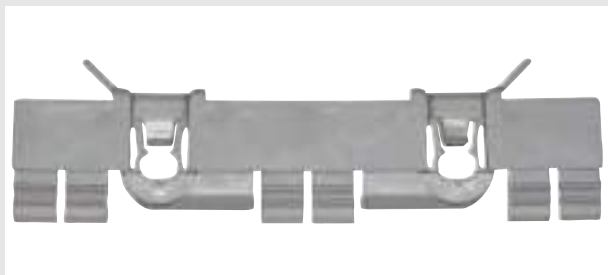

Art. No. 0501 303 002

Orig. No.: 90562265
188573
Eurocode: 6284ASCHD
Fig. No.: 69



Art. No. 0501 303 003

Orig. No.: 188550
9133248
Eurocode: 6284ASCH6B
Fig. No.: 70



Art. No. 0501 103 088

Orig. No.: 188581
90580920
Fig. No.: 71



Art. No. 0501 103 089

Orig. No.: 188580
9131181
Eurocode: 6284ASCH8B
Fig. No.: 72

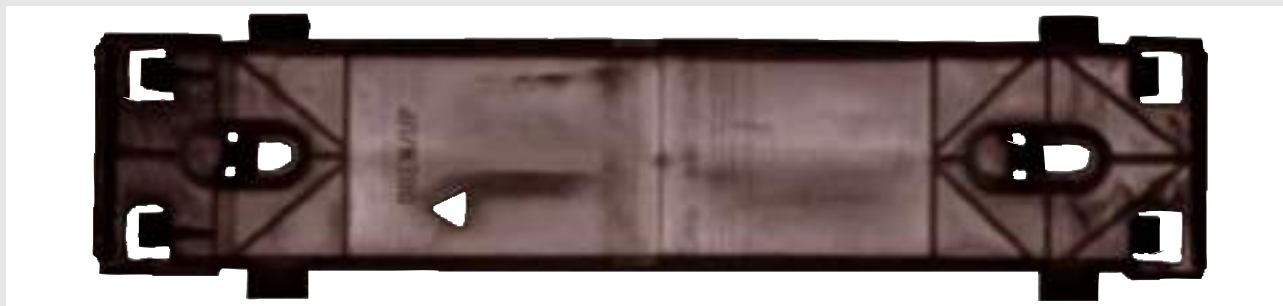

Art. No. 0501 103 029

Orig. No.: 129947
90414801
Fig. No.: 73



Art. No. 0501 103 090

Orig. No.: 188577
9131114
Eurocode: 6284ASCH7B
Fig. No.: 74



Art. No. 0501 103 103

Orig. No.: 172923
90590944
Fig. No.: 75

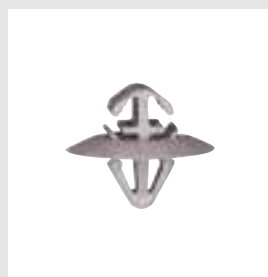

Art. No. 0501 103 091

Orig. No.: 93160023
4409693
4412053
Fig. No.: 76

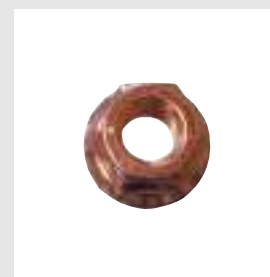

Art. No. 0365 6

Orig. No.: 854906
90080883
Fig. No.: 77

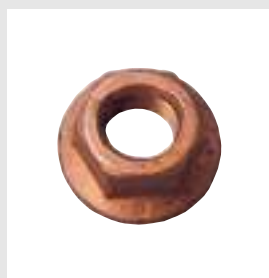

Art. No. 0365 65

Orig. No.: 854976
90108169
Fig. No.: 78

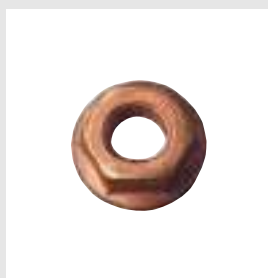

Art. No. 0365 61

Orig. No.: 2066915
2066156
Fig. No.: 79



Art. No. 0501 103 046

Orig. No.: 350888
90538057
Fig. No.: 80

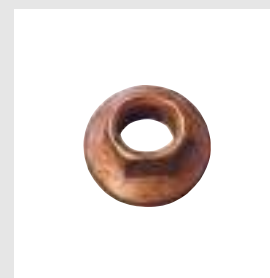

Art. No. 0501 103 047

Orig. No.: 849928
90502418
Fig. No.: 81



Art. No. 0501 103 048

Orig. No.: 856563
90323550
Fig. No.: 82

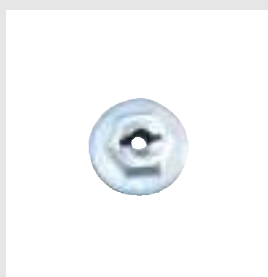

Art. No. 0500 119 141

Orig. No.: 176653
6699672
Fig. No.: 83



Art. No. 0103 055 19

Orig. No.: 2038253
11067771
Fig. No.: 84

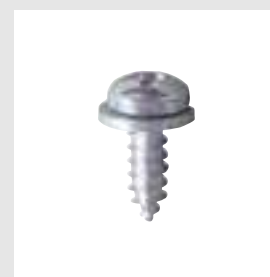

Art. No. 0103 055 16

Orig. No.: 2038251
Fig. No.: 85

**Art. No. 0103 055 25**

Orig. No.: 2038261
11068913
Fig. No.: 86

**Art. No. 0362 412 15**

Orig. No.: 90473457
1008504
Fig. No.: 87

**Art. No. 0501 103 024**

Orig. No.: 1320763
90321425
Fig. No.: 88

**Art. No. 0501 103 059**

Orig. No.: 1216903
Fig. No.: 89

**Art. No. 0501 103 004**

Orig. No.: 1218601
90181010
Fig. No.: 90

**Art. No. 0501 103 069**

Orig. No.: 1217801
90321482
Fig. No.: 91

**Art. No. 0501 103 072**

Orig. No.: 1218604
90386374
Fig. No.: 92

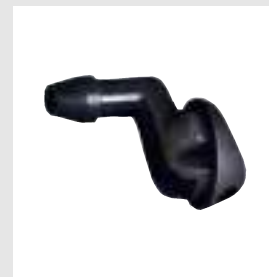
**Art. No. 0501 103 074**

Orig. No.: 1451166
90087621
Fig. No.: 93

Index sorted by Art. No.						
Art. No.	Orig. No.	Eurocode	Designation	Car type	Fig.	P. Qty.
0103 055 16	2038251		LICENSE PLATE SCREW 7981 5.5 X 16 GALV.*	-	85	100
0103 055 19	2038253		LICENSE PLATE SCREW 7981 5.5 X 19 GALV.*	CALIBRA, ASCONA C, CORSA A+B, TIGRA, KADETTE E, OMEGA A, SENATOR B	84	100
0103 055 19	11067771		LICENSE PLATE SCREW 7981 5.5 X 19 GALV.*	CALIBRA, ASCONA C, CORSA A+B, TIGRA, KADETTE E, OMEGA A, SENATOR B	84	100
0103 055 25	2038261		LICENSE PLATE SCREW 7981 5.5 X 25 GALV.*	CALIBRA, VECTRA A+B, CORSA A+B, TIGRA, KADETTE E, ASTRA, OMEGA A+B, SENATOR	86	100
0103 055 25	11068913		LICENSE PLATE SCREW 7981 5.5 X 25 GALV.*	CALIBRA, VECTRA A+B, CORSA A+B, TIGRA, KADETTE E, ASTRA, OMEGA A+B, SENATOR	86	100
0129 48 19	2020005		COMBINATION SCREW 7976B 4.8 X 19 GALV. 3*	ASCONA C, CORSA A, OMEGA A, SENATOR B	32	
0129 48 19	11071511		COMBINATION SCREW 7976B 4.8 X 19 GALV. 3*	ASCONA C, CORSA A, OMEGA A, SENATOR B	32	
0362 412 15	90473457		WHEEL BOLT GALV. CLR. M12X1.5X22 17 MM *	CORSA C, MERIVA, TIGRA B, VECTRA C, SIGNUM, ZAFIRA B, ASTRA H	87	50
0362 412 15	1008504		WHEEL BOLT GALV. CLR. M12X1.5X22 17 MM *	CORSA C, MERIVA, TIGRA B, VECTRA C, SIGNUM, ZAFIRA B, ASTRA H	87	50
0365 6	854906		FLANGED NUT M 8 BK 13 H 10 CU COAT.*	CALIBRA, ASCONA C, VECTRA A, KADETTE E	77	50
0365 6	90080883		FLANGED NUT M 8 BK 13 H 10 CU COAT.*	CALIBRA, ASCONA C, VECTRA A, KADETTE E	77	50
0365 61	2066915		FLANGED NUT M 8 BK 13 H 8 SELF-LOCKING* CU COAT.*	CORSA C, MERIVA, TIGRA B, VECTRA C, SIGNUM	79	50
0365 61	2066156		FLANGED NUT M 8 BK 13 H 8 SELF-LOCKING* CU COAT.*	CORSA C, MERIVA, TIGRA B, VECTRA C, SIGNUM	79	50
0365 65	854976		FLANGED NUT M 10 BK 15 H 10 CU COAT.*	OMEGA A 1987 - 1993, SENATOR B 1988 - 1994	78	50
0365 65	90108169		FLANGED NUT M 10 BK 15 H 10 CU COAT.*	OMEGA A 1987 - 1993, SENATOR B 1988 - 1994	78	50
0500 113 69	207217565		SHEET-METAL NUT ST 6.3 MM GALV. CLR. PASSIV. MATT	-	14	100
0500 114 03	2072151		SHEET-METAL NUT ST 6.3 MM HALF GALV. CLR. PASSIV. MATT	VARIOUS MODELS	15	100
0500 114 27	207217563		SHEET-METAL NUT ST 6.3 MM GALV.	CORSA, KADETTE, ASTRA	18	100
0500 115 77	2072077		SHEET-METAL NUT ST 5.5 MM GALV. CLR. PASSIV. MATT	VARIOUS MODELS	13	100
0500 117 07	174610		GROMMET FOR LETTERING PE 181 CLR.	-	52	100
0500 117 61			SHEET-METAL NUT ST. 8.0 GALV. CLR. PASSIV.	-	16	50
0500 119 141	176653		SEALING NUT M 3 FOR REAR SPOILER SELF-LOCKING	CORSA A 1983 - 1992	83	25
0500 119 141	6699672		SEALING NUT M 3 FOR REAR SPOILER SELF-LOCKING	CORSA A 1983 - 1992	83	25
0500 121 6	2084170		BLIND RIVET 4.8 x 11.0 ALUMIN./STEEL	UNIVERSAL	11	100
0500 121 6	11086102		BLIND RIVET 4.8 x 11.0 ALUMIN./STEEL	UNIVERSAL	11	100
0500 124 28	167935		PLASTIC SPLIT RIVET PA 122 BLACK *	-	36	50
0500 127 09	2240861		BLACK FIR-TREE CLIP	UNIVERSAL	2	50
0500 127 09	90022049		BLACK FIR-TREE CLIP	UNIVERSAL	2	50

Index sorted by Art. No.						
Art. No.	Orig. No.	Eurocode	Designation	Car type	Fig.	P. Qty.
0500 127 10	1719242		PLASTIC SPLIT RIVET PA6 BK	CORSA B, ASTRA G	35	50
0500 127 10	90058826		PLASTIC SPLIT RIVET PA6 BK	CORSA B, ASTRA G	35	50
0500 132 04	2072153		SHEET-METAL NUT ST 6.3 MM HALF GALV. CLR. PASSIV.	CALIBRA, ASCONA C, VECTRA C, CORSA A, KADETTE E, OMEGA A, SENATOR B	17	100
0500 132 04	11072461		SHEET-METAL NUT ST 6.3 MM HALF GALV. CLR. PASSIV.	CALIBRA, ASCONA C, VECTRA C, CORSA A, KADETTE E, OMEGA A, SENATOR B	17	100
0500 133	164361		ALUMIN./STEEL BLIND RIVET A2	UNIVERSAL	10	50
0500 133	90033713		ALUMIN./STEEL BLIND RIVET A2	UNIVERSAL	10	50
0500 134 550	1190365		LICENSE PLATE FASTENER PA 6 BLACK	CALIBRA, ASTRA, KADETTE E, OMEGA A+B	46	25
0500 134 550	90139015		LICENSE PLATE FASTENER PA 6 BLACK	CALIBRA, ASTRA, KADETTE E, OMEGA A+B	46	25
0500 136 31	2240587		INTERIOR LINING CLIP FOR DOOR PA 661 BLACK	ASCONA C, CORSA A, KADETTE E	54	100
0500 136 31	2240593		INTERIOR LINING CLIP FOR DOOR PA 661 BLACK	ASCONA C, CORSA A, KADETTE E	54	100
0500 136 31	90321121		INTERIOR LINING CLIP FOR DOOR PA 661 BLACK	ASCONA C, CORSA A, KADETTE E	54	100
0500 151 97	1216957		EXPANDING NUT PA 6 COLORLESS	UNIVERSAL	47	50
0500 151 97	90230960		EXPANDING NUT PA 6 COLORLESS	UNIVERSAL	47	50
0500 307 71			SPRING COTTER A2*	-	24	50
0500 402 9	1162484		FIR-TREE CLIP PE BLACK	UNIVERSAL	7	100
0500 402 9	90040750		FIR-TREE CLIP PE BLACK	UNIVERSAL	7	100
0500 500 08	100490		UPHOLSTERY CLIP CU COAT.	CORSA C, MERIVA, VECTRA C, SIGNUM, ZAFIRA B, ASTRA H	60	500
0500 500 08	6616858		UPHOLSTERY CLIP CU COAT.	CORSA C, MERIVA, VECTRA C, SIGNUM, ZAFIRA B, ASTRA H	60	500
0500 879 33	2240802		EXPANDING NUT PA6 GF 30 BK	CORSA C, MERIVA, TIGRA B, VECTRA C, SIGNUM, ZAFIRA B, ASTRA H	51	50
0500 879 33	90230846		EXPANDING NUT PA6 GF 30 BK	CORSA C, MERIVA, TIGRA B, VECTRA C, SIGNUM, ZAFIRA B, ASTRA H	51	50
0500 939 5	2338955		BLACK FIR-TREE CLIP	OMEGA B 1994 - 2003	6	50
0500 939 5	90431553		BLACK FIR-TREE CLIP	OMEGA B 1994 - 2003	6	50
0500 939 6	2344879		FIR-TREE CLIP PA66 BLACK	ASCONA C 1982 - 1988	4	25
0500 939 6	90152926		FIR-TREE CLIP PA66 BLACK	ASCONA C 1982 - 1988	4	25
0501 101 000	1104880		PLASTIC SPLIT RIVET PA66 BK	CORSA C, MERIVA, VECTRA C, SIGNUM, ZAFIRA B, ASTRA H	40	100
0501 101 000	90087290		PLASTIC SPLIT RIVET PA66 BK	CORSA C, MERIVA, VECTRA C, SIGNUM, ZAFIRA B, ASTRA H	40	100
0501 102 001	1288548		ROD RETAINER DIA. 7.0 - 21.0 MM POM BLACK	CALIBRA, VECTRA A, ASTRA, ASTRA CLASSIC, OMEGA A+B	31	25
0501 102 001	90230571		ROD RETAINER DIA. 7.0 - 21.0 MM POM BLACK	CALIBRA, VECTRA A, ASTRA, ASTRA CLASSIC, OMEGA A+B	31	25

Index sorted by Art. No.						
Art. No.	Orig. No.	Eurocode	Designation	Car type	Fig.	P. Qty.
0501 103 001	174851		TRIM CLIP WITH RUBBER INSERT WHITE	CALIBRA 1989 - 1997	66	25
0501 103 001	90355565		TRIM CLIP WITH RUBBER INSERT WHITE	CALIBRA 1989 - 1997	66	25
0501 103 003	164978		TRIM CLIP	VECTRA A, CORSA A+B, TIGRA, KADETTE E	65	50
0501 103 003	90196277		TRIM CLIP	VECTRA A, CORSA A+B, TIGRA, KADETTE E	65	50
0501 103 004	1218601		HEADLIGHT FASTENER POM 130 COLORLESS	KADETTE E, OMEGA A, FROTERA A, SENATOR B	90	25
0501 103 004	90181010		HEADLIGHT FASTENER POM 130 COLORLESS	KADETTE E, OMEGA A, FROTERA A, SENATOR B	90	25
0501 103 009	1320979		EXPANDING NUT PA 6 NATURAL	OMEGA A+B	48	50
0501 103 009	90246677		EXPANDING NUT PA 6 NATURAL	OMEGA A+B	48	50
0501 103 010	1406984		EXPANDING NUT WITH FOAM DISK PA 6 BLACK	VECTRA C, SIGNUM, CALIBRA, CORSA B, TIGRA	49	25
0501 103 010	90482706		EXPANDING NUT WITH FOAM DISK PA 6 BLACK	VECTRA C, SIGNUM, CALIBRA, CORSA B, TIGRA	49	25
0501 103 011	2345957		INTERIOR LINING CLIP FOR DOOR WHITE	CORSA C, MERIVA, VECTRA C, SIGNUM, ZAFIRA B, ASTRA H	55	100
0501 103 011	90321122		INTERIOR LINING CLIP FOR DOOR WHITE	CORSA C, MERIVA, VECTRA C, SIGNUM, ZAFIRA B, ASTRA H	55	100
0501 103 012	2345959		INTERIOR LINING CLIP FOR DOOR RED	CORSA C, MERIVA, TIGRA B, VECTRA C, SIGNUM	56	50
0501 103 012	90457899		INTERIOR LINING CLIP FOR DOOR RED	CORSA C, MERIVA, TIGRA B, VECTRA C, SIGNUM	56	50
0501 103 015	1719245		BLACK PLASTIC SPLIT RIVET	CORSA C, MERIVA, TIGRA B, VECTRA C, SIGNUM, ZAFIRA B, ASTRA H	38	50
0501 103 015	90138810		BLACK PLASTIC SPLIT RIVET	CORSA C, MERIVA, TIGRA B, VECTRA C, SIGNUM, ZAFIRA B, ASTRA H	38	50
0501 103 017	1400806		PLASTIC SPLIT RIVET WITH CAP PA 66 BLACK	CORSA C, ASTRA G+H, ZAFIRA B, VECTRA B+C, VECTRA C, SIGNUM; TIGRA B, MERIVA	39	25
0501 103 017	90508809		PLASTIC SPLIT RIVET WITH CAP PA 66 BLACK	CORSA C, ASTRA G+H, ZAFIRA B, VECTRA B+C, VECTRA C, SIGNUM; TIGRA B, MERIVA	39	25
0501 103 019	1288885		CABLE TIE PA 66 BLACK *	TIGRA, VECTRA A+B+C, SIGNUM, CALIBRA, ASCONA C, ASTRA CLASSIC, CORSA A+B	27	25
0501 103 019	90381846		CABLE TIE PA 66 BLACK *	TIGRA, VECTRA A+B+C, SIGNUM, CALIBRA, ASCONA C, ASTRA CLASSIC, CORSA A+B	27	25
0501 103 020	1406970		SHEET-METAL NUT ST 6.3 MET. CORR. PROT. 2.0 SI	ASCONA C 1982 - 1988, CORSA A 1983 - 1992	19	100
0501 103 020	90158565		SHEET-METAL NUT ST 6.3 MET. CORR. PROT. 2.0 SI	ASCONA C 1982 - 1988, CORSA A 1983 - 1992	19	100

Index sorted by Art. No.						
Art. No.	Orig. No.	Eurocode	Designation	Car type	Fig.	P. Qty.
0501 103 024	1320763		GUIDE CLIP BLACK	CORSA A 1983 - 1992, ASTRA 1992 - 1998	88	50
0501 103 024	90321425		GUIDE CLIP BLACK	CORSA A 1983 - 1992, ASTRA 1992 - 1998	88	50
0501 103 029	129947		TRIM CLIP FOR TAILGATE	ASTRA 1992 - 1998	73	25
0501 103 029	90414801		TRIM CLIP FOR TRUNK LID	ASTRA 1992 - 1998	73	25
0501 103 035	2317703		PLASTIC SPLIT RIVET PA 661 BLACK	OMEGA A+B, ASTRA G, ZAFIRA A, CORSA A, VECTRA A+B, ASCONA C	37	25
0501 103 035	90116376		PLASTIC SPLIT RIVET PA 661 BLACK	OMEGA A+B, ASTRA G, ZAFIRA A, CORSA A, VECTRA A+B, ASCONA C	37	25
0501 103 036	353900		LOCKING PIN GALV. CLR.	CALIBRA, ASCONA C, VECTRA C, ASTRA CLASSIC, KADETTE E, ASTRA	23	25
0501 103 036	90305718		LOCKING PIN GALV. CLR.	CALIBRA, ASCONA C, VECTRA C, ASTRA CLASSIC, KADETTE E, ASTRA	23	25
0501 103 043	1162488		COVER PLUG FOR ENGINE HOOD INSULA- TION	CORSA B+C, ASTRA G, ZAFIRA, VECTRA A+B+C	5	100
0501 103 043	90355604		COVER PLUG FOR ENGINE HOOD INSULA- TION	CORSA B+C, ASTRA G, ZAFIRA, VECTRA A+B+C	5	100
0501 103 046	350888		STOVER NUT M 12 x 1.5 GALV.*	CORSA C, MERIVA, TIGRA B, ZAFIRA B, VECTRA C, SIGNUM, ASTRA H	80	25
0501 103 046	90538057		STOVER NUT M 12 x 1.5 GALV.*	CORSA C, MERIVA, TIGRA B, ZAFIRA B, VECTRA C, SIGNUM, ASTRA H	80	25
0501 103 047	849928		FLANGED NUT SELF-LOCKING M8 10 MM CU COAT. 6 MY*	CORSA C, MERIVA, TIGRA B, VECTRA C, SIGNUM, ZAFIRA B, ASTRA H	81	50
0501 103 047	90502418		FLANGED NUT SELF-LOCKING M8 10 MM CU COAT. 6 MY*	CORSA C, MERIVA, TIGRA B, VECTRA C, SIGNUM, ZAFIRA B, ASTRA H	81	50
0501 103 048	856563		SHAFT LOCK GE0 321	CALIBRA, VECTRA A+B, ASTRA CLASSIC, CORSA B, TIGRA	82	25
0501 103 048	90323550		SHAFT LOCK GE0 321	CALIBRA, VECTRA A+B, ASTRA CLASSIC, CORSA B, TIGRA	82	25
0501 103 052	1400906		SHEET-METAL NUT M 5 SELF-LOCKING GALV. CLR. PASSIV.	UNIVERSAL	20	100
0501 103 052	90464538		SHEET-METAL NUT M 5 SELF-LOCKING GALV. CLR. PASSIV.	UNIVERSAL	20	100
0501 103 054	1406528		ALUMIN./STEEL BLIND RIVET 4.0 x 14.0	UNIVERSAL	12	100
0501 103 054	90589346		ALUMIN./STEEL BLIND RIVET 4.0 x 14.0	UNIVERSAL	12	100
0501 103 055	2026706		COMBINATION SCREW 7976B 5.5 X 19 8 MM GALV. CLR.	UNIVERSAL	33	100
0501 103 055	11093351		COMBINATION SCREW 7976B 5.5 X 19 8 MM GALV. CLR.	UNIVERSAL	33	100
0501 103 057	2064162		WASHER NUT M 6 GALV.	CORSA C, TIGRA B, VECTRA C, SIGNUM, ZAFIRA B	44	25
0501 103 057	11095121		WASHER NUT M 6 GALV.	CORSA C, TIGRA B, VECTRA C, SIGNUM, ZAFIRA B	44	25

Index sorted by Art. No.						
Art. No.	Orig. No.	Eurocode	Designation	Car type	Fig.	P. Qty.
0501 103 058	2322200		U-CLIP FOR SEAT UPHOLSTERY PHOSD.	CORSA C, ZAFIRA B, ASTRA H, VECTRA A+B	53	100
0501 103 058	3458462		U-CLIP FOR SEAT UPHOLSTERY PHOSD.	CORSA C, ZAFIRA B, ASTRA H, VECTRA A+B	53	100
0501 103 059	1216903		HEADLIGHT FASTENER POM 130 COLORLESS	-	89	25
0501 103 060	1101412		COMBINATION SCREW 7976A 6.3 X 16 GALV. CLR.	ASCONA C, CORSA A, KADETTE E, OMEGA A, SENATOR B	34	100
0501 103 060	9287493		COMBINATION SCREW 7976A 6.3 X 16 GALV. CLR.	ASCONA C, CORSA A, KADETTE E, OMEGA A, SENATOR B	34	100
0501 103 063	1235884		PLASTIC SHEET-METAL NUT PP GREEN	UNIVERSAL	21	50
0501 103 063	24417039		PLASTIC SHEET-METAL NUT PP GREEN	UNIVERSAL	21	50
0501 103 064	1180216		ROD RETAINER DIA. 7.0 - 8.5 MM POM BLACK	CORSA B, CALIBRA, VECTRA A, OMEGA A, OMEGA B	29	100
0501 103 064	90246867		ROD RETAINER DIA. 7.0 - 8.5 MM POM BLACK	CORSA B, CALIBRA, VECTRA A, OMEGA A, OMEGA B	29	100
0501 103 065	1406925		PLASTIC SPLIT RIVET PA 66 BLACK	VECTRA C, SIGNUM, ZAFIRA B, ASTRA H, OMEGA B	43	25
0501 103 065	9130754		PLASTIC SPLIT RIVET PA 66 BLACK	VECTRA C, SIGNUM, ZAFIRA B, ASTRA H, OMEGA B	43	25
0501 103 067	1336956		ROD RETAINER 20.0 MM DIA. POM BLACK	MERIVA, ZAFIRA B, ASTRA H, CALIBRA, VECTRA A, CORSA B, TIGRA	30	50
0501 103 067	90324923		ROD RETAINER 20.0 MM DIA. POM BLACK	MERIVA, ZAFIRA B, ASTRA H, CALIBRA, VECTRA A, CORSA B, TIGRA	30	50
0501 103 068	1104882		PLASTIC SPLIT RIVET PA 661 BLACK*	MERIVA, TIGRA B, VECTRA C, ZAFIRA B, ASTRA H	42	50
0501 103 068	90450482		PLASTIC SPLIT RIVET PA 661 BLACK*	MERIVA, TIGRA B, VECTRA C, ZAFIRA B, ASTRA H	42	50
0501 103 069	1217801		HEADLIGHT FASTENER POM COLORLESS	CORSA A 1983 - 1992	91	100
0501 103 069	90321482		HEADLIGHT FASTENER POM COLORLESS	CORSA A 1983 - 1992	91	100
0501 103 071	2208843		COVER CAP FOR CARPET POM 309 BLACK	ZAFIRA B, ASTRA H, VECTRA A+B, OMEGA A+B	45	25
0501 103 071	90218614		COVER CAP FOR CARPET POM 309 BLACK	ZAFIRA B, ASTRA H, VECTRA A+B, OMEGA A+B	45	25
0501 103 072	1218604		HEADLIGHT FASTENER POM COLORLESS	CORSA B, TIGRA A	92	25
0501 103 072	90386374		HEADLIGHT FASTENER POM COLORLESS	CORSA B, TIGRA A	92	25
0501 103 073	2346824		FIR-TREE CLIP PA 6 BLACK	UNIVERSAL	8	50
0501 103 073	90283614		FIR-TREE CLIP PA 6 BLACK	UNIVERSAL	8	50
0501 103 074	1451166		WATER SPRAY NOZZLES PA 6 GRAY	ASCONA C 1982 - 1988, CORSA A 1983 - 1992	93	100
0501 103 074	90087621		WATER SPRAY NOZZLES PA 6 GRAY	ASCONA C 1982 - 1988, CORSA A 1983 - 1992	93	100
0501 103 076	1190970		BLACK EXPANDING NUT	UNIVERSAL	50	50
0501 103 076	90053803		BLACK EXPANDING NUT	UNIVERSAL	50	50
0501 103 077	2226953		FIR-TREE CLIP PA 6 GRAY	UNIVERSAL	9	50
0501 103 077	90328384		FIR-TREE CLIP PA 6 GRAY	UNIVERSAL	9	50

Index sorted by Art. No.						
Art. No.	Orig. No.	Eurocode	Designation	Car type	Fig.	P. Qty.
0501 103 078	1288888		CABLE TIE WITH BASE 4.8x132 MM PA 66 NATURAL*	CORSA B+C, VECTRA A+B+C, ZAFIRA A+B, SINT-RA, CALIBRA, TIGRA, ASTRA G, OMEGA B	28	25
0501 103 078	90461994		CABLE TIE WITH BASE 4.8x132 MM PA 66 NATURAL*	CORSA B+C, VECTRA A+B+C, ZAFIRA A+B, SINT-RA, CALIBRA, TIGRA, ASTRA G, OMEGA B	28	25
0501 103 080	174825		COLORLESS TRIM CLIP	-	62	100
0501 103 081	174853		TRIM CLIP	VECTRA B 1996 - 2002, OMEGA A 1987 - 1993	63	50
0501 103 081	90376175		TRIM CLIP	VECTRA B 1996 - 2002, OMEGA A 1987 - 1993	63	50
0501 103 085	174854		TRIM CLIP WHEEL WELL COVER	VECTRA C, SIGNUM, CORSA B, TIGRA, ASTRA G, ZAFIRA A	61	25
0501 103 085	90481595		TRIM CLIP WHEEL WELL COVER	VECTRA C, SIGNUM, CORSA B, TIGRA, ASTRA G, ZAFIRA A	61	25
0501 103 086	1222141		BLUE INTERIOR LINING CLIP + A2 CLIP	CORSA C, MERIVA, VECTRA C, SIGNUM, ZAFIRA B, ASTRA H	57	100
0501 103 086	24405740		BLUE INTERIOR LINING CLIP + A2 CLIP	CORSA C, MERIVA, VECTRA C, SIGNUM, ZAFIRA B, ASTRA H	57	100
0501 103 087	2228839	6290ASCH	INTERIOR LINING CLIP POM BLACK + A2 CLIP	CORSA C, MERIVA, VECTRA C, SIGNUM, ZAFIRA B, ASTRA H	58	100
0501 103 087	24405739	6290ASCH	INTERIOR LINING CLIP POM BLACK + A2 CLIP	CORSA C, MERIVA, VECTRA C, SIGNUM, ZAFIRA B, ASTRA H	58	100
0501 103 088	188581		TRIM CLIP POM BLACK	ASTRA G + ZAFIRA A 1998 - 2005	71	100
0501 103 088	90580920		TRIM CLIP POM BLACK	ASTRA G + ZAFIRA A 1998 - 2005	71	100
0501 103 089	188580	6284ASCH8B	TRIM CLIP WIDE POM GRAY	ASTRA G + ZAFIRA A 1998 - 2005	72	25
0501 103 089	9131181	6284ASCH8B	TRIM CLIP WIDE POM GRAY	ASTRA G + ZAFIRA A 1998 - 2005	72	25
0501 103 090	188577	6284ASCH7B	TRIM CLIP WIDE POM BLACK	ASTRA G + ZAFIRA A 1998 - 2005	74	25
0501 103 090	9131114	6284ASCH7B	TRIM CLIP WIDE POM BLACK	ASTRA G + ZAFIRA A 1998 - 2005	74	25
0501 103 091	93160023		GRAY TRIM CLIP	VIVARO	76	100
0501 103 091	4409693		GRAY TRIM CLIP	VIVARO	76	100
0501 103 091	4412053		GRAY TRIM CLIP	VIVARO	76	100
0501 103 100	174977		TRIM CLIP FOR STONE CHIP PROTECTION WHITE	-	64	25
0501 103 101	164980		TRIM CLIP COLORLESS POM	VECTRA A 1989 - 1995, OMEGA B 1994 - 2003	67	10
0501 103 101	90347304		TRIM CLIP COLORLESS POM	VECTRA A 1989 - 1995, OMEGA B 1994 - 2003	67	10
0501 103 102	171963		TRIM CLIP COLORLESS POM	OMEGA B 1994 - 2003	68	25
0501 103 102	90460866		TRIM CLIP COLORLESS POM	OMEGA B 1994 - 2003	68	25

Index sorted by Art. No.						
Art. No.	Orig. No.	Eurocode	Designation	Car type	Fig.	P. Qty.
0501 103 103	172923		TRIM CLIP POM GRAY	ASTRA G + ZAFIRA A 1998 - 2005	75	100
0501 103 103	90590944		TRIM CLIP POM GRAY	ASTRA G + ZAFIRA A 1998 - 2005	75	100
0501 104 038	1104881		PLASTIC SPLIT RIVET BK UNDERRIDE GUARD FASTENER PA122	CALIBRA 1989 - 1997, ASTRA 1992 - 1998	41	50
0501 104 038	90356928		PLASTIC SPLIT RIVET BK UNDERRIDE GUARD FASTENER PA122	CALIBRA 1989 - 1997, ASTRA 1992 - 1998	41	50
0501 104 105			FIR-TREE CLIP PE BLACK	-	3	50
0501 104 118	850856		PRESTOLE CAGE NUT FOR ENGINE COMP. LINING MET. CORR. PROT. SI	UNIVERSAL	25	25
0501 104 118	90270271		PRESTOLE CAGE NUT FOR ENGINE COMP. LINING MET. CORR. PROT. SI	UNIVERSAL	25	25
0501 105 601	2207713		BLACK FIR-TREE CLIP	CORSA A, VECTRA C, SIGNUM, ASTRA H, KADETTE E	1	25
0501 105 601	90082231		BLACK FIR-TREE CLIP	CORSA A, VECTRA C, SIGNUM, ASTRA H, KADETTE E	1	25
0501 106 095	136511		METAL CLIP LOCK FOR WINDOW CRANK OILED	UNIVERSAL	26	100
0501 106 095	6235332		METAL CLIP LOCK FOR WINDOW CRANK OILED	UNIVERSAL	26	100
0501 167 022	4414667		INTERIOR LINING CLIP POM COLORLESS/ GRAY	VIVARO AB 2001	59	25
0501 167 022	91169651		INTERIOR LINING CLIP POM COLORLESS/ GRAY	VIVARO AB 2001	59	25
0501 303 001	5104988	6302ASCHB	CLIP FOR WATER BAFFLE PLATE COLORLESS	ASTRA H	22	25
0501 303 001	13155024	6302ASCHB	CLIP FOR WATER BAFFLE PLATE COLORLESS	ASTRA H	22	25
0501 303 002	90562265	6284ASCHD	GRAY TRIM CLIP	ASTRA G	69	25
0501 303 002	188573	6284ASCHD	GRAY TRIM CLIP	ASTRA G	69	25
0501 303 003	188550	6284ASCH6B	WHITE TRIM CLIP	ASTRA G, ZAFIRA A	70	25
0501 303 003	9133248	6284ASCH6B	WHITE TRIM CLIP	ASTRA G, ZAFIRA A	70	25

Index sorted by Orig. No.						
Orig. No.	Art. No.	Eurocode	Designation	Car type	Fig.	P. Qty.
	0501 104 105		FIR-TREE CLIP PE BLACK	-	3	50
100490	0500 500 08		UPHOLSTERY CLIP CU COAT.	CORSA C, MERIVA, VECTRA C, SIGNUM, ZAFIRA B, ASTRA H	60	500
6616858	0500 500 08		UPHOLSTERY CLIP CU COAT.	CORSA C, MERIVA, VECTRA C, SIGNUM, ZAFIRA B, ASTRA H	60	500
1101412	0501 103 060		COMBINATION SCREW 7976A 6.3 X 16 GALV. CLR.	ASCONA C, CORSA A, KADETTE E, OMEGA A, SENATOR B	34	100
9287493	0501 103 060		COMBINATION SCREW 7976A 6.3 X 16 GALV. CLR.	ASCONA C, CORSA A, KADETTE E, OMEGA A, SENATOR B	34	100
1104880	0501 101 000		PLASTIC SPLIT RIVET PA66 BK	CORSA C, MERIVA, VECTRA C, SIGNUM, ZAFIRA B, ASTRA H	40	100
90087290	0501 101 000		PLASTIC SPLIT RIVET PA66 BK	CORSA C, MERIVA, VECTRA C, SIGNUM, ZAFIRA B, ASTRA H	40	100
1104881	0501 104 038		PLASTIC SPLIT RIVET BK UNDERRIDE GUARD FASTENER PA122	CALIBRA 1989 - 1997, ASTRA 1992 - 1998	41	50
90356928	0501 104 038		PLASTIC SPLIT RIVET BK UNDERRIDE GUARD FASTENER PA122	CALIBRA 1989 - 1997, ASTRA 1992 - 1998	41	50
1104882	0501 103 068		PLASTIC SPLIT RIVET PA 661 BLACK*	MERIVA, TIGRA B, VECTRA C, ZAFIRA B, ASTRA H	42	50
90450482	0501 103 068		PLASTIC SPLIT RIVET PA 661 BLACK*	MERIVA, TIGRA B, VECTRA C, ZAFIRA B, ASTRA H	42	50
1162484	0500 402 9		FIR-TREE CLIP PE BLACK	UNIVERSAL	7	100
90040750	0500 402 9		FIR-TREE CLIP PE BLACK	UNIVERSAL	7	100
1162488	0501 103 043		COVER PLUG FOR ENGINE HOOD INSULATION	CORSA B+C, ASTRA G, ZAFIRA, VECTRA A+B+C	5	100
90355604	0501 103 043		COVER PLUG FOR ENGINE HOOD INSULATION	CORSA B+C, ASTRA G, ZAFIRA, VECTRA A+B+C	5	100
1180216	0501 103 064		ROD RETAINER DIA. 7.0 - 8.5 MM POM BLACK	CORSA B, CALIBRA, VECTRA A, OMEGA A, OMEGA B	29	100
90246867	0501 103 064		ROD RETAINER DIA. 7.0 - 8.5 MM POM BLACK	CORSA B, CALIBRA, VECTRA A, OMEGA A, OMEGA B	29	100
1190365	0500 134 550		LICENSE PLATE FASTENER PA 6 BLACK	CALIBRA, ASTRA, KADETTE E, OMEGA A+B	46	25
90139015	0500 134 550		LICENSE PLATE FASTENER PA 6 BLACK	CALIBRA, ASTRA, KADETTE E, OMEGA A+B	46	25
1190970	0501 103 076		BLACK EXPANDING NUT	UNIVERSAL	50	50
90053803	0501 103 076		BLACK EXPANDING NUT	UNIVERSAL	50	50
1216903	0501 103 059		HEADLIGHT FASTENER POM 130 COLORLESS	-	89	25
1216957	0500 151 97		EXPANDING NUT PA 6 COLORLESS	UNIVERSAL	47	50
90230960	0500 151 97		EXPANDING NUT PA 6 COLORLESS	UNIVERSAL	47	50
1217801	0501 103 069		HEADLIGHT FASTENER POM COLORLESS	CORSA A 1983 - 1992	91	100
90321482	0501 103 069		HEADLIGHT FASTENER POM COLORLESS	CORSA A 1983 - 1992	91	100
1218601	0501 103 004		HEADLIGHT FASTENER POM 130 COLORLESS	KADETTE E, OMEGA A, FROTERA A, SENATOR B	90	25
90181010	0501 103 004		HEADLIGHT FASTENER POM 130 COLORLESS	KADETTE E, OMEGA A, FROTERA A, SENATOR B	90	25
1218604	0501 103 072		HEADLIGHT FASTENER POM COLORLESS	CORSA B, TIGRA A	92	25
90386374	0501 103 072		HEADLIGHT FASTENER POM COLORLESS	CORSA B, TIGRA A	92	25

Index sorted by Orig. No.						
Orig. No.	Art. No.	Eurocode	Designation	Car type	Fig.	P. Qty.
1222141	0501 103 086		BLUE INTERIOR LINING CLIP + A2 CLIP	CORSA C, MERIVA, VECTRA C, SIGNUM, ZAFIRA B, ASTRA H	57	100
24405740	0501 103 086		BLUE INTERIOR LINING CLIP + A2 CLIP	CORSA C, MERIVA, VECTRA C, SIGNUM, ZAFIRA B, ASTRA H	57	100
1235884	0501 103 063		PLASTIC SHEET-METAL NUT PP GREEN	UNIVERSAL	21	50
24417039	0501 103 063		PLASTIC SHEET-METAL NUT PP GREEN	UNIVERSAL	21	50
1288548	0501 102 001		ROD RETAINER DIA. 7.0 - 21.0 MM POM BLACK	CALIBRA, VECTRA A, ASTRA, ASTRA CLASSIC, OMEGA A+B	31	25
90230571	0501 102 001		ROD RETAINER DIA. 7.0 - 21.0 MM POM BLACK	CALIBRA, VECTRA A, ASTRA, ASTRA CLASSIC, OMEGA A+B	31	25
1288885	0501 103 019		CABLE TIE PA 66 BLACK *	TIGRA, VECTRA A+B+C, SIGNUM, CALIBRA, ASCONAC, ASTRA CLASSIC, CORSA A+B	27	25
90381846	0501 103 019		CABLE TIE PA 66 BLACK *	TIGRA, VECTRA A+B+C, SIGNUM, CALIBRA, ASCONAC, ASTRA CLASSIC, CORSA A+B	27	25
1288888	0501 103 078		CABLE TIE WITH BASE 4.8x132 MM PA 66 NATURAL*	CORSA B+C, VECTRA A+B+C, ZAFIRA A+B, SINT-RA, CALIBRA, TIGRA, ASTRA G, OMEGA B	28	25
90461994	0501 103 078		CABLE TIE WITH BASE 4.8x132 MM PA 66 NATURAL*	CORSA B+C, VECTRA A+B+C, ZAFIRA A+B, SINT-RA, CALIBRA, TIGRA, ASTRA G, OMEGA B	28	25
129947	0501 103 029		TRIM CLIP FOR TAILGATE	ASTRA 1992 - 1998	73	25
90414801	0501 103 029		TRIM CLIP FOR TAILGATE	ASTRA 1992 - 1998	73	25
1320763	0501 103 024		GUIDE CLIP BLACK	CORSA A 1983 - 1992, ASTRA 1992 - 1998	88	50
90321425	0501 103 024		GUIDE CLIP BLACK	CORSA A 1983 - 1992, ASTRA 1992 - 1998	88	50
1320979	0501 103 009		EXPANDING NUT PA 6 NATURAL	OMEGA A+B	48	50
90246677	0501 103 009		EXPANDING NUT PA 6 NATURAL	OMEGA A+B	48	50
1336956	0501 103 067		ROD RETAINER 20.0 MM DIA. POM BLACK	MERIVA, ZAFIRA B, ASTRA H, CALIBRA, VECTRA A, CORSA B, TIGRA	30	50
90324923	0501 103 067		ROD RETAINER 20.0 MM DIA. POM BLACK	MERIVA, ZAFIRA B, ASTRA H, CALIBRA, VECTRA A, CORSA B, TIGRA	30	50
136511	0501 106 095		METAL CLIP LOCK FOR WINDOW CRANK OILED	UNIVERSAL	26	100
6235332	0501 106 095		METAL CLIP LOCK FOR WINDOW CRANK OILED	UNIVERSAL	26	100
1400806	0501 103 017		PLASTIC SPLIT RIVET WITH CAP PA 66 BLACK	CORSA C, ASTRA G+H, ZAFIRA B, VECTRA B+C, VECTRA C, SIGNUM; TIGRA B, MERIVA	39	25
90508809	0501 103 017		PLASTIC SPLIT RIVET WITH CAP PA 66 BLACK	CORSA C, ASTRA G+H, ZAFIRA B, VECTRA B+C, VECTRA C, SIGNUM; TIGRA B, MERIVA	39	25

Index sorted by Orig. No.						
Orig. No.	Art. No.	Eurocode	Designation	Car type	Fig.	P. Qty.
1400906	0501 103 052		SHEET-METAL NUT M 5 SELF-LOCKING GALV. CLR. PASSIV.	UNIVERSAL	20	100
90464538	0501 103 052		SHEET-METAL NUT M 5 SELF-LOCKING GALV. CLR. PASSIV.	UNIVERSAL	20	100
1406528	0501 103 054		ALUMIN./STEEL BLIND RIVET 4.0 x 14.0	UNIVERSAL	12	100
90589346	0501 103 054		ALUMIN./STEEL BLIND RIVET 4.0 x 14.0	UNIVERSAL	12	100
1406925	0501 103 065		PLASTIC SPLIT RIVET PA 66 BLACK	VECTRA C, SIGNUM, ZAFIRA B, ASTRA H, OMEGA B	43	25
9130754	0501 103 065		PLASTIC SPLIT RIVET PA 66 BLACK	VECTRA C, SIGNUM, ZAFIRA B, ASTRA H, OMEGA B	43	25
1406970	0501 103 020		SHEET-METAL NUT ST 6.3 MET. CORR. PROT. 2.0 SI	ASCONA C 1982 - 1988, CORSA A 1983 - 1992	19	100
90158565	0501 103 020		SHEET-METAL NUT ST 6.3 MET. CORR. PROT. 2.0 SI	ASCONA C 1982 - 1988, CORSA A 1983 - 1992	19	100
1406984	0501 103 010		EXPANDING NUT WITH FOAM DISK PA 6 BLACK	VECTRA C, SIGNUM, CALIBRA, CORSA B, TIGRA	49	25
90482706	0501 103 010		EXPANDING NUT WITH FOAM DISK PA 6 BLACK	VECTRA C, SIGNUM, CALIBRA, CORSA B, TIGRA	49	25
1451166	0501 103 074		WATER SPRAY NOZZLES PA 6 GRAY	ASCONA C 1982 - 1988, CORSA A 1983 - 1992	93	100
90087621	0501 103 074		WATER SPRAY NOZZLES PA 6 GRAY	ASCONA C 1982 - 1988, CORSA A 1983 - 1992	93	100
164361	0500 133		ALUMIN./STEEL BLIND RIVET A2	UNIVERSAL	10	50
90033713	0500 133		ALUMIN./STEEL BLIND RIVET A2	UNIVERSAL	10	50
164978	0501 103 003		TRIM CLIP	VECTRA A, CORSA A+B, TIGRA, KADETTE E	65	50
90196277	0501 103 003		TRIM CLIP	VECTRA A, CORSA A+B, TIGRA, KADETTE E	65	50
164980	0501 103 101		TRIM CLIP COLORLESS POM	VECTRA A 1989 - 1995, OMEGA B 1994 - 2003	67	10
90347304	0501 103 101		TRIM CLIP COLORLESS POM	VECTRA A 1989 - 1995, OMEGA B 1994 - 2003	67	10
167935	0500 124 28		PLASTIC SPLIT RIVET PA 122 BLACK *	-	36	50
1719242	0500 127 10		PLASTIC SPLIT RIVET PA6 BK	CORSA B, ASTRA G	35	50
90058826	0500 127 10		PLASTIC SPLIT RIVET PA6 BK	CORSA B, ASTRA G	35	50
1719245	0501 103 015		BLACK PLASTIC SPLIT RIVET	CORSA C, MERIVA, TIGRA B, VECTRA C, SIGNUM, ZAFIRA B, ASTRA H	38	50
90138810	0501 103 015		BLACK PLASTIC SPLIT RIVET	CORSA C, MERIVA, TIGRA B, VECTRA C, SIGNUM, ZAFIRA B, ASTRA H	38	50
171963	0501 103 102		TRIM CLIP COLORLESS POM	OMEGA B 1994 - 2003	68	25
90460866	0501 103 102		TRIM CLIP COLORLESS POM	OMEGA B 1994 - 2003	68	25
172923	0501 103 103		TRIM CLIP POM GRAY	ASTRA G + ZAFIRA A 1998 - 2005	75	100
90590944	0501 103 103		TRIM CLIP POM GRAY	ASTRA G + ZAFIRA A 1998 - 2005	75	100
174610	0500 117 07		GROMMET FOR LETTERING PE 181 CLR.	-	52	100
174825	0501 103 080		COLORLESS TRIM CLIP	-	62	100
174851	0501 103 001		TRIM CLIP WITH RUBBER INSERT WHITE	CALIBRA 1989 - 1997	66	25
90355565	0501 103 001		TRIM CLIP WITH RUBBER INSERT WHITE	CALIBRA 1989 - 1997	66	25

Index sorted by Orig. No.						
Orig. No.	Art. No.	Eurocode	Designation	Car type	Fig.	P. Qty.
174853	0501 103 081		TRIM CLIP	VECTRA B 1996 - 2002, OMEGA A 1987 - 1993	63	50
90376175	0501 103 081		TRIM CLIP	VECTRA B 1996 - 2002, OMEGA A 1987 - 1993	63	50
174854	0501 103 085		TRIM CLIP WHEEL WELL COVER	VECTRA C, SIGNUM, CORSA B, TIGRA, ASTRA G, ZAFIRA A	61	25
90481595	0501 103 085		TRIM CLIP WHEEL WELL COVER	VECTRA C, SIGNUM, CORSA B, TIGRA, ASTRA G, ZAFIRA A	61	25
174977	0501 103 100		TRIM CLIP FOR STONE CHIP PROTECTION WHITE	-	64	25
176653	0500 119 141		SEALING NUT M 3 FOR REAR SPOILER SELF- LOCKING	CORSA A 1983 - 1992	83	25
6699672	0500 119 141		SEALING NUT M 3 FOR REAR SPOILER SELF- LOCKING	CORSA A 1983 - 1992	83	25
188550	0501 303 003	6284ASCH6B	WHITE TRIM CLIP	ASTRA G, ZAFIRA A	70	25
9133248	0501 303 003	6284ASCH6B	WHITE TRIM CLIP	ASTRA G, ZAFIRA A	70	25
188577	0501 103 090	6284ASCH7B	TRIM CLIP WIDE POM BLACK	ASTRA G + ZAFIRA A 1998 - 2005	74	25
9131114	0501 103 090	6284ASCH7B	TRIM CLIP WIDE POM BLACK	ASTRA G + ZAFIRA A 1998 - 2005	74	25
188580	0501 103 089	6284ASCH8B	TRIM CLIP WIDE POM GRAY	ASTRA G + ZAFIRA A 1998 - 2005	72	25
9131181	0501 103 089	6284ASCH8B	TRIM CLIP WIDE POM GRAY	ASTRA G + ZAFIRA A 1998 - 2005	72	25
188581	0501 103 088		TRIM CLIP POM BLACK	ASTRA G + ZAFIRA A 1998 - 2005	71	100
90580920	0501 103 088		TRIM CLIP POM BLACK	ASTRA G + ZAFIRA A 1998 - 2005	71	100
2020005	0129 48 19		COMBINATION SCREW 7976B 4.8 X 19 GALV. 3*	ASCONA C, CORSA A, OMEGA A, SENATOR B	32	
11071511	0129 48 19		COMBINATION SCREW 7976B 4.8 X 19 GALV. 3*	ASCONA C, CORSA A, OMEGA A, SENATOR B	32	
2026706	0501 103 055		COMBINATION SCREW 7976B 5.5 X 19 8 MM GALV. CLR.	UNIVERSAL	33	100
11093351	0501 103 055		COMBINATION SCREW 7976B 5.5 X 19 8 MM GALV. CLR.	UNIVERSAL	33	100
2038251	0103 055 16		LICENSE PLATE SCREW 7981 5.5 X 16 GALV.*	-	85	100
2038253	0103 055 19		LICENSE PLATE SCREW 7981 5.5 X 19 GALV. *	CALIBRA, ASCONA C, COR- SA A+B, TIGRA, KADETTE E, OMEGA A, SENATOR B	84	100
11067771	0103 055 19		LICENSE PLATE SCREW 7981 5.5 X 19 GALV. *	CALIBRA, ASCONA C, COR- SA A+B, TIGRA, KADETTE E, OMEGA A, SENATOR B	84	100
2038261	0103 055 25		LICENSE PLATE SCREW 7981 5.5 X 25 GALV.*	CALIBRA, VECTRA A+B, COR- SA A+B, TIGRA, KADETTE E, ASTRA, OMEGA A+B, SENATOR	86	100
11068913	0103 055 25		LICENSE PLATE SCREW 7981 5.5 X 25 GALV.*	CALIBRA, VECTRA A+B, COR- SA A+B, TIGRA, KADETTE E, ASTRA, OMEGA A+B, SENATOR	86	100

Index sorted by Orig. No.						
Orig. No.	Art. No.	Eurocode	Designation	Car type	Fig.	P. Qty.
2064162	0501 103 057		WASHER NUT M 6 GALV.	CORSA C, TIGRA B, VECTRA C, SIGNUM, ZAFIRA B	44	25
11095121	0501 103 057		WASHER NUT M 6 GALV.	CORSA C, TIGRA B, VECTRA C, SIGNUM, ZAFIRA B	44	25
2066915	0365 61		FLANGED NUT M 8 BK 13 H 8 SELF-LOCKING* CU COAT.*	CORSA C, MERIVA, TIGRA B, VECTRA C, SIGNUM	79	50
2066156	0365 61		FLANGED NUT M 8 BK 13 H 8 SELF-LOCKING* CU COAT.*	CORSA C, MERIVA, TIGRA B, VECTRA C, SIGNUM	79	50
2072077	0500 115 77		SHEET-METAL NUT ST 5.5 MM GALV. CLR. PASSIV. MATT	VARIOUS MODELS	13	100
2072151	0500 114 03		SHEET-METAL NUT ST 6.3 MM HALF GALV. CLR. PASSIV. MATT	VARIOUS MODELS	15	100
2072153	0500 132 04		SHEET-METAL NUT ST 6.3 MM HALF GALV. CLR. PASSIV.	CALIBRA, ASCONA C, VECTRA C, CORSA A, KADETTE E, OMEGA A, SENATOR B	17	100
11072461	0500 132 04		SHEET-METAL NUT ST 6.3 MM HALF GALV. CLR. PASSIV.	CALIBRA, ASCONA C, VECTRA C, CORSA A, KADETTE E, OMEGA A, SENATOR B	17	100
207217563	0500 114 27		SHEET-METAL NUT ST 6.3 MM GALV.	CORSA, KADETTE, ASTRA	18	100
207217565	0500 113 69		SHEET-METAL NUT ST 6.3 MM GALV. CLR. PASSIV. MATT	-	14	100
2084170	0500 121 6		BLIND RIVET 4.8 x 11.0 ALUMIN./STEEL	UNIVERSAL	11	100
11086102	0500 121 6		BLIND RIVET 4.8 x 11.0 ALUMIN./STEEL	UNIVERSAL	11	100
2207713	0501 105 601		BLACK FIR-TREE CLIP	CORSA A, VECTRA C, SIGNUM, ASTRA H, KADETTE E	1	25
90082231	0501 105 601		BLACK FIR-TREE CLIP	CORSA A, VECTRA C, SIGNUM, ASTRA H, KADETTE E	1	25
2208843	0501 103 071		COVER CAP FOR CARPET POM 309 BLACK	ZAFIRA B, ASTRA H, VECTRA A+B, OMEGA A+B	45	25
90218614	0501 103 071		COVER CAP FOR CARPET POM 309 BLACK	ZAFIRA B, ASTRA H, VECTRA A+B, OMEGA A+B	45	25
2226953	0501 103 077		FIR-TREE CLIP PA 6 GRAY	UNIVERSAL	9	50
90328384	0501 103 077		FIR-TREE CLIP PA 6 GRAY	UNIVERSAL	9	50
2228839	0501 103 087	6290ASCH	INTERIOR LINING CLIP POM BLACK + A2 CLIP	CORSA C, MERIVA, VECTRA C, SIGNUM, ZAFIRA B, ASTRA H	58	100
24405739	0501 103 087	6290ASCH	INTERIOR LINING CLIP POM BLACK + A2 CLIP	CORSA C, MERIVA, VECTRA C, SIGNUM, ZAFIRA B, ASTRA H	58	100
2240587	0500 136 31		INTERIOR LINING CLIP FOR DOOR PA 661 BLACK	ASCONA C, CORSA A, KADETTE E	54	100
2240593	0500 136 31		INTERIOR LINING CLIP FOR DOOR PA 661 BLACK	ASCONA C, CORSA A, KADETTE E	54	100
90321121	0500 136 31		INTERIOR LINING CLIP FOR DOOR PA 661 BLACK	ASCONA C, CORSA A, KADETTE E	54	100
2240802	0500 879 33		EXPANDING NUT PA6 GF 30 BK	CORSA C, MERIVA, TIGRA B, VECTRA C, SIGNUM, ZAFIRA B, ASTRA H	51	50
90230846	0500 879 33		EXPANDING NUT PA6 GF 30 BK	CORSA C, MERIVA, TIGRA B, VECTRA C, SIGNUM, ZAFIRA B, ASTRA H	51	50
2240861	0500 127 09		BLACK FIR-TREE CLIP	UNIVERSAL	2	50
90022049	0500 127 09		BLACK FIR-TREE CLIP	UNIVERSAL	2	50

Index sorted by Orig. No.						
Orig. No.	Art. No.	Eurocode	Designation	Car type	Fig.	P. Qty.
2317703	0501 103 035		PLASTIC SPLIT RIVET PA 661 BLACK	OMEGA A+B, ASTRA G, ZAFIRA A, CORSA A, VECTRA A+B, ASCONA C	37	25
90116376	0501 103 035		PLASTIC SPLIT RIVET PA 661 BLACK	OMEGA A+B, ASTRA G, ZAFIRA A, CORSA A, VECTRA A+B, ASCONA C	37	25
2322200	0501 103 058		U-CLIP FOR SEAT UPHOLSTERY PHOSD.	CORSA C, ZAFIRA B, ASTRA H, VECTRA A+B	53	100
3458462	0501 103 058		U-CLIP FOR SEAT UPHOLSTERY PHOSD.	CORSA C, ZAFIRA B, ASTRA H, VECTRA A+B	53	100
2338955	0500 939 5		BLACK FIR-TREE CLIP	OMEGA B 1994 - 2003	6	50
90431553	0500 939 5		BLACK FIR-TREE CLIP	OMEGA B 1994 - 2003	6	50
2344879	0500 939 6		FIR-TREE CLIP PA66 BLACK	ASCONA C 1982 - 1988	4	25
90152926	0500 939 6		FIR-TREE CLIP PA66 BLACK	ASCONA C 1982 - 1988	4	25
2345957	0501 103 011		INTERIOR LINING CLIP FOR DOOR WHITE	CORSA C, MERIVA, VECTRA C, SIGNUM, ZAFIRA B, ASTRA H	55	100
90321122	0501 103 011		INTERIOR LINING CLIP FOR DOOR WHITE	CORSA C, MERIVA, VECTRA C, SIGNUM, ZAFIRA B, ASTRA H	55	100
2345959	0501 103 012		INTERIOR LINING CLIP FOR DOOR RED	CORSA C, MERIVA, TIGRA B, VECTRA C, SIGNUM	56	50
90457899	0501 103 012		INTERIOR LINING CLIP FOR DOOR RED	CORSA C, MERIVA, TIGRA B, VECTRA C, SIGNUM	56	50
2346824	0501 103 073		FIR-TREE CLIP PA 6 BLACK	UNIVERSAL	8	50
90283614	0501 103 073		FIR-TREE CLIP PA 6 BLACK	UNIVERSAL	8	50
350888	0501 103 046		STOVER NUT M 12 x 1.5 GALV.*	CORSA C, MERIVA, TIGRA B, ZAFIRA B, VECTRA C, SIGNUM, ASTRA H	80	25
90538057	0501 103 046		STOVER NUT M 12 x 1.5 GALV.*	CORSA C, MERIVA, TIGRA B, ZAFIRA B, VECTRA C, SIGNUM, ASTRA H	80	25
353900	0501 103 036		LOCKING PIN GALV. CLR.	CALIBRA, ASCONA C, VECTRA C, ASTRA CLASSIC, KADETTE E, ASTRA	23	25
90305718	0501 103 036		LOCKING PIN GALV. CLR.	CALIBRA, ASCONA C, VECTRA C, ASTRA CLASSIC, KADETTE E, ASTRA	23	25
4414667	0501 167 022		INTERIOR LINING CLIP POM COLORLESS/ GRAY	VIVARO AB 2001	59	25
91169651	0501 167 022		INTERIOR LINING CLIP POM COLORLESS/ GRAY	VIVARO AB 2001	59	25
5104988	0501 303 001	6302ASCHB	CLIP FOR WATER BAFFLE PLATE COLORLESS	ASTRA H	22	25
13155024	0501 303 001	6302ASCHB	CLIP FOR WATER BAFFLE PLATE COLORLESS	ASTRA H	22	25
849928	0501 103 047		FLANGED NUT SELF-LOCKING M8 10 MM CU COAT. 6 MY*	CORSA C, MERIVA, TIGRA B, VECTRA C, SIGNUM, ZAFIRA B, ASTRA H	81	50
90502418	0501 103 047		FLANGED NUT SELF-LOCKING M8 10 MM CU COAT. 6 MY*	CORSA C, MERIVA, TIGRA B, VECTRA C, SIGNUM, ZAFIRA B, ASTRA H	81	50
850856	0501 104 118		PRESTOLE CAGE NUT FOR ENGINE COMP. LINING MET. CORR. PROT. SI	UNIVERSAL	25	25
90270271	0501 104 118		PRESTOLE CAGE NUT FOR ENGINE COMP. LINING MET. CORR. PROT. SI	UNIVERSAL	25	25

Index sorted by Orig. No.						
Orig. No.	Art. No.	Eurocode	Designation	Car type	Fig.	P. Qty.
854906	0365 6		FLANGED NUT M 8 BK 13 H 10 CU COAT.*	CALIBRA, ASCONA C, VECTRA A, KADETTE E	77	50
90080883	0365 6		FLANGED NUT M 8 BK 13 H 10 CU COAT.*	CALIBRA, ASCONA C, VECTRA A, KADETTE E	77	50
854976	0365 65		FLANGED NUT M 10 BK 15 H 10 CU COAT.*	OMEGA A 1987 - 1993, SENATOR B 1988 - 1994	78	50
90108169	0365 65		FLANGED NUT M 10 BK 15 H 10 CU COAT.*	OMEGA A 1987 - 1993, SENATOR B 1988 - 1994	78	50
856563	0501 103 048		SHAFT LOCK GE0 321	CALIBRA, VECTRA A+B, ASTRA CLASSIC, CORSA B, TIGRA	82	25
90323550	0501 103 048		SHAFT LOCK GE0 321	CALIBRA, VECTRA A+B, ASTRA CLASSIC, CORSA B, TIGRA	82	25
90473457	0362 412 15		WHEEL BOLT GALV. CLR. M12X1.5X22 17 MM *	CORSA C, MERIVA, TIGRA B, VECTRA C, SIGNUM, ZAFIRA B, ASTRA H	87	50
1008504	0362 412 15		WHEEL BOLT GALV. CLR. M12X1.5X22 17 MM *	CORSA C, MERIVA, TIGRA B, VECTRA C, SIGNUM, ZAFIRA B, ASTRA H	87	50
90562265	0501 303 002	6284ASCHD	GRAY TRIM CLIP	ASTRA G	69	25
188573	0501 303 002	6284ASCHD	GRAY TRIM CLIP	ASTRA G	69	25
93160023	0501 103 091		GRAY TRIM CLIP	VIVARO	76	100
4409693	0501 103 091		GRAY TRIM CLIP	VIVARO	76	100
4412053	0501 103 091		GRAY TRIM CLIP	VIVARO	76	100

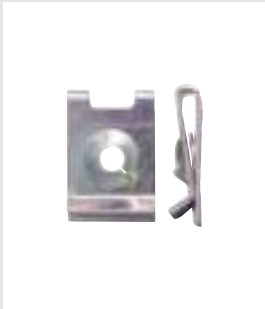

Art. No. 0500 121 9
 Orig. No.: 99959146002
 Fig. No.: 1



Art. No. 0501 104 066
 Orig. No.: 99950707202
 Fig. No.: 2



Art. No. 0501 121 117
 Orig. No.: 99950749740
 Fig. No.: 3

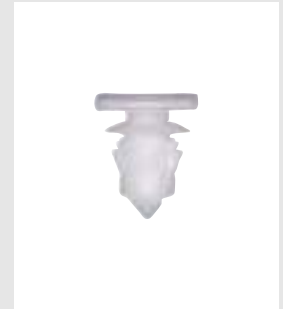

Art. No. 0501 101 660
 Orig. No.: 99959145240
 Fig. No.: 4



Art. No. 0501 121 141
 Orig. No.: 99950761640
 Fig. No.: 5

Index sorted by Art. No.						
Art. No.	Orig. No.	Eurocode	Designation	Car type	Fig.	P. Qty.
0500 121 9	99959146002		SHEET-METAL NUT ST 3.5 MM GALV. CLR. PASSIV.	-	1	100
0501 101 660	99959145240		INTERIOR LINING CLIP POM COLORLESS	-	4	100
0501 104 066	99950707202		SHEET-METAL NUT ST 4.8 ZN MET. CORR. PROT. 10.2 SI	-	2	100
0501 121 117	99950749740		PLASTIC SPLIT RIVET PA 6 BLACK	-	3	50
0501 121 141	99950761640		THREADED BLIND RIVET WITH TORX DIA. 5.8 - 10.0 MM POM/PA 6 BLACK	-	5	25

Index sorted by Orig. No.						
Orig. No.	Art. No.	Eurocode	Designation	Car type	Fig.	P. Qty.
99950707202	0501 104 066		SHEET-METAL NUT ST 4.8 ZN MET. CORR. PROT. 10.2 SI	-	2	100
99950749740	0501 121 117		PLASTIC SPLIT RIVET PA 6 BLACK	-	3	50
99950761640	0501 121 141		THREADED BLIND RIVET WITH TORX DIA. 5.8 - 10.0 MM POM/PA 6 BLACK	-	5	25
99959145240	0501 101 660		INTERIOR LINING CLIP POM COLORLESS	-	4	100
99959146002	0500 121 9		SHEET-METAL NUT ST 3.5 MM GALV. CLR. PASSIV.	-	1	100



Art. No. 0500 132 300
 Orig. No.: 5000355136
 Fig. No.: 1

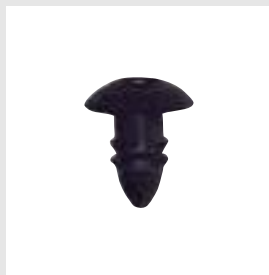

Art. No. 0501 167 001
 Orig. No.: 7703077135
 Fig. No.: 2



Art. No. 0500 680 7
 Orig. No.: 7703077096
 Fig. No.: 3

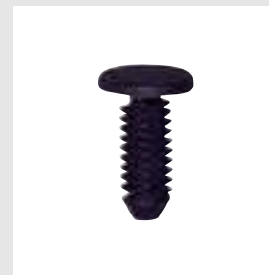

Art. No. 0500 682 9
 Orig. No.: 7703077066
 Fig. No.: 4

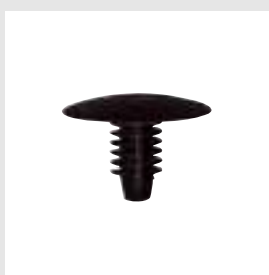

Art. No. 0500 680 3
 Orig. No.: 7703077068
 Fig. No.: 5

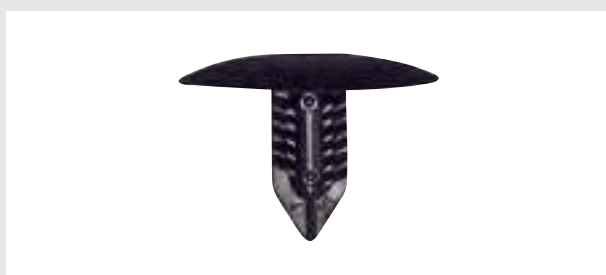

Art. No. 0501 167 002
 Orig. No.: 7703077435
 Fig. No.: 6

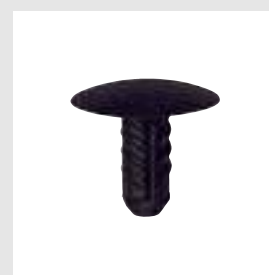

Art. No. 0501 167 003
 Orig. No.: 7703077444
 Fig. No.: 7



Art. No. 0501 167 004
 Orig. No.: 7703077453
 Fig. No.: 8



Art. No. 0501 167 005
 Orig. No.: 7703077225
 Fig. No.: 9

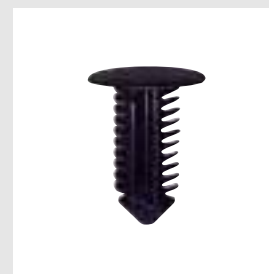

Art. No. 0501 167 006
 Orig. No.: 7703077153
 Fig. No.: 10



Art. No. 0501 167 007
 Orig. No.: 7703077117
 Fig. No.: 11



Art. No. 0501 167 008
 Orig. No.: 7703081054
 7703081227
 Fig. No.: 12



Art. No. 0501 167 031
 Orig. No.: 8200110307
 Fig. No.: 13

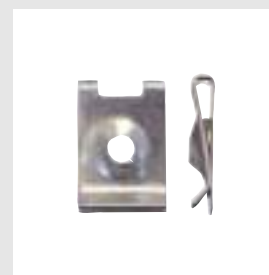

Art. No. 0500 113 62
 Orig. No.: 7703046115
 Fig. No.: 14



Art. No. 0500 533 12
 Orig. No.: 7703046034
 Fig. No.: 15

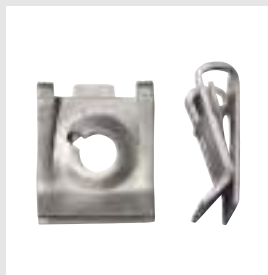

Art. No. 0501 167 009
 Orig. No.: 7703046049
 Fig. No.: 16



Art. No. 0501 167 010
 Orig. No.: 7703079822
 Fig. No.: 17

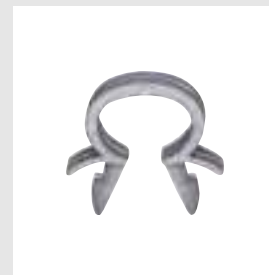

Art. No. 0500 531 64
 Orig. No.: 7703079070
 Fig. No.: 18



Art. No. 0501 167 011
 Orig. No.: 7703044037
 Fig. No.: 19



Art. No. 0501 167 012
 Orig. No.: 7703044087
 Fig. No.: 20



Art. No. 0500 523 14
 Orig. No.:
 Fig. No.: 21



Art. No. 0500 127 10
 Orig. No.: 7703072172
 Fig. No.: 22



Art. No. 0501 167 058
 Orig. No.: 7703072144
 Fig. No.: 23



Art. No. 0500 124 28
 Orig. No.: 7703072173
 Fig. No.: 24



Art. No. 0501 101 628
 Orig. No.: 7703072502
 Fig. No.: 25



Art. No. 0501 121 118
 Orig. No.: 7703072224
 Eurocode: 6539ASSH
 Fig. No.: 26

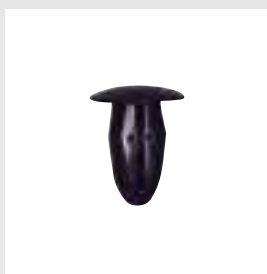

Art. No. 0501 121 122
 Orig. No.: 7703077078
 Fig. No.: 27



Art. No. 0501 167 013
 Orig. No.: 7703081160
 Fig. No.: 28



Art. No. 0501 167 014
 Orig. No.: 7703081184
 Fig. No.: 29

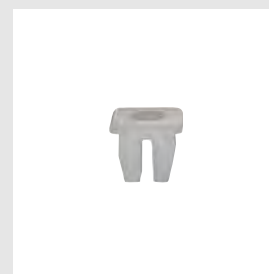

Art. No. 0501 167 059
 Orig. No.: 7703081086
 Fig. No.: 30

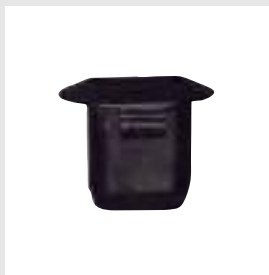

Art. No. 0501 121 124
Orig. No.: 7703081176
Fig. No.: 31



Art. No. 0501 121 125
Orig. No.: 7703081019
Fig. No.: 32



Art. No. 0501 167 016
Orig. No.: 7703081190
Fig. No.: 33

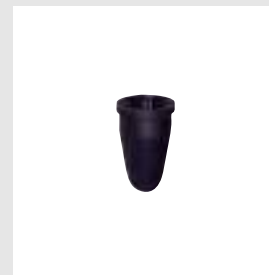

Art. No. 0501 167 017
Orig. No.: 7703081151
Fig. No.: 34



Art. No. 0501 167 018
Orig. No.: 7700836190
Fig. No.: 35



Art. No. 0500 680 8
Orig. No.: 7703077111
Fig. No.: 36



Art. No. 0501 167 019
Orig. No.: 7703077250
Fig. No.: 37



Art. No. 0501 167 020
Orig. No.: 8200702219
7701049008
Fig. No.: 38



Art. No. 0501 167 021
Orig. No.: 7703077368
Fig. No.: 39



Art. No. 0501 167 022
Orig. No.: 7703077430
Fig. No.: 40

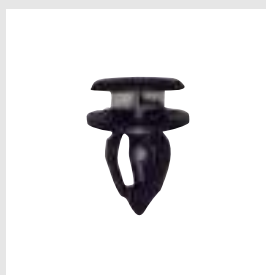

Art. No. 0501 167 023
Orig. No.: 7703077434
Fig. No.: 41



Art. No. 0501 121 130
Orig. No.:
Eurocode: 2730ASCTS1B
Fig. No.: 42



Art. No. 0501 121 132
Orig. No.: 7703077469
Fig. No.: 43

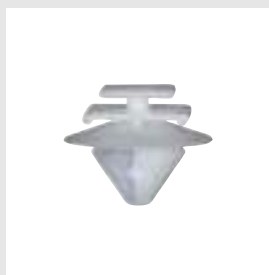

Art. No. 0501 121 134
Orig. No.: 7701049270
Eurocode: 6545ASCTB
6539ASCTB
Fig. No.: 44

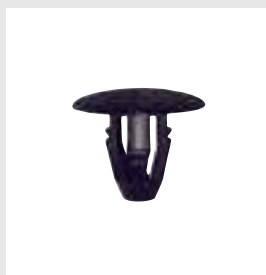

Art. No. 0501 167 024
Orig. No.: 7703077322
Fig. No.: 45

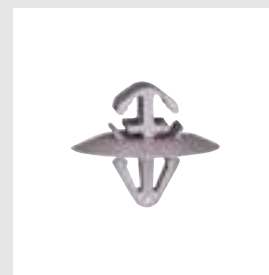

Art. No. 0501 103 091
Orig. No.:
Fig. No.: 46



Art. No. 0501 167 025
 Orig. No.: 7703077362
 Fig. No.: 47



Art. No. 0501 167 026
 Orig. No.: 7703077448
 Fig. No.: 48



Art. No. 0501 167 033
 Orig. No.:
 Fig. No.: 49



Art. No. 0362 212 15
 Orig. No.: 8200030701
 Fig. No.: 50



Art. No. 0501 121 140
 Orig. No.: 7703072236
 Fig. No.: 51

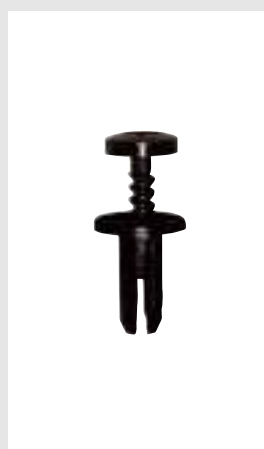

Art. No. 0501 121 141
 Orig. No.: 7703072261
 Fig. No.: 52



Art. No. 0501 167 028
 Orig. No.: 7703072360
 Fig. No.: 53



Art. No. 0501 367 002
 Orig. No.: 7700351266
 Eurocode: 7247ASCV
 Fig. No.: 54



Art. No. 0501 367 003
 Orig. No.: 7700827632
 Eurocode: 7237ASCHBR
 Fig. No.: 55



Art. No. 0501 367 004
 Orig. No.: 7700827631
 Eurocode: 7237ASCHBL
 Fig. No.: 56



Art. No. 0501 367 001
 Orig. No.: 7700838570
 Eurocode: 7246ASCV
 Fig. No.: 57



Art. No. 0501 167 029
 Orig. No.: 7803072272
 Eurocode: 7231LSCHFD
 Fig. No.: 58



Art. No. 0501 167 060
 Orig. No.: 7703077428
 Fig. No.: 59



Art. No. 0501 167 030
 Orig. No.: 7703077256
 Fig. No.: 60

Index sorted by Art. No.						
Art. No.	Orig. No.	Eurocode	Designation	Car type	Fig.	P. Qty.
0362 212 15	8200030701		WHEEL BOLT GALV. CLR. M12X1.5X23 19 MM *	-	50	50
0500 113 62	7703046115		SHEET-METAL NUT ST 4.2 MM GALV. CLR. PASSIV.	-	14	100
0500 124 28	7703072173		PLASTIC SPLIT RIVET PA 122 BLACK *	-	24	50
0500 127 10	7703072172		PLASTIC SPLIT RIVET PA6 BK	TWINGO II	22	50
0500 132 300	5000355136		FIR-TREE CLIP PE BLACK	-	1	50
0500 523 14			PLASTIC SPLIT RIVET PA12 BLACK	-	21	50
0500 531 64	7703079070		PLASTIC CABLE CLAMP 9.5 MM PA 6 GRAY	UNIVERSAL	18	25
0500 533 12	7703046034		SHEET-METAL NUT M 6 MET. CORR. PROT. 2.2 SI GLIDE ADDIT.	R-9/11, CLIO, SUPER-5, EXPRESS, LAGUNA, SAFRANE, ESPACE, MASTER, TRAFIC	15	100
0500 680 3	7703077068		COVER PLUG RENAULT/CITROËN POM BLACK	R-9, R-11, R-19, R-21, R-25, SUPER-5, EXPRESS, CLIO, MEGANE, TWINGO, LAGUNA, SAFRANE, ESPACE	5	50
0500 680 7	7703077096		COVER PLUG RENAULT GRAY	-	3	25
0500 680 8	7703077111		INTERIOR LINING CLIP FOR RENAULT/CITROËN	R11, R18, R5, R9, TRAFIC, SUPER-5, EXPRESS, MASTER	36	25
0500 682 9	7703077066		FIR-TREE CLIP PA 66 BLACK	FUEGO, R18, R25, R5	4	50
0501 101 628	7703072502		PLASTIC SPLIT RIVET PA 12 BLACK*	-	25	25
0501 103 091			TRIM CLIP GRAY	KANGOO, MASTER, TRAFIC	46	100
0501 121 118	7703072224	6539ASSH	BLACK PLASTIC SPLIT RIVET POM 902 BLACK 4.0 - 4.2 MM	-	26	100
0501 121 122	7703077078		PLASTIC RIVET WITHOUT PIN	R4, R5, SUPERCINQUE	27	100
0501 121 124	7703081176		BLACK EXPANDING NUT	MEGANE, KANGOO, ESPACE, MASTER	31	50
0501 121 125	7703081019		COLORLESS EXPANDING NUT	R9, R11, CLIO, SUPER-5, EXPRESS, MEGANE, LAGUNA, SAFRANE, TWINGO, ESPACE, MASTER	32	100
0501 121 130		2730ASCTS1B	INTERIOR LINING CLIP PA CLR.	106 PHASE II, 206, 207, 307, 405, 406, 407, 607, 806 PH2, C2, C3, C4 C5, XSARA II	42	50
0501 121 132	7703077469		INTERIOR LINING CLIP POM COLORLESS	MEGANE II, CLIO II, CLIO III	43	25
0501 121 134	7701049270	6545ASCTB 6539ASCHB	COLORLESS INTERIOR LINING CLIP	TWINGO II	44	25
0501 121 140	7703072236		THREADED BLIND RIVET POM BLACK	R19, R21, SUPER-5, EXPRESS, KANGOO, LAGUNA	51	100
0501 121 141	7703072261		THREADED BLIND RIVET WITH TORX DIA. 5.8 - 10.0 MM POM/PA 6 BLACK	-	52	25
0501 167 001	7703077135		FIR-TREE CLIP DIA. 6.4 - 6.7 MM PE LD BLACK	-	2	100
0501 167 002	7703077435		BLACK FIR-TREE CLIP	CLIO 1+2, ESPACE, KANGOO, LAGUNA 1+2, LOGAN, MASTER, MEGANE 1+2, MODUS, SCENIC 1+2, TRAFIC 2, TWINGO	6	25
0501 167 003	7703077444		BLACK COVER PLUG	CLIO II, KANGOO, LAGUNA	7	50
0501 167 004	7703077453		BLACK COVER PLUG	LAGUNA II, MASTER, VEL SATIS	8	100
0501 167 005	7703077225		BLACK COVER PLUG	R-19, R-25, CLIO, SUPER-5, EXPRESS, KANGOO, MEGANE, TWINGO, LAGUNA, SAFRANE, MASTER, TRAFIC	9	50

Index sorted by Art. No.						
Art. No.	Orig. No.	Eurocode	Designation	Car type	Fig.	P. Qty.
0501 167 006	7703077153		BLACK COVER PLUG	CLIO	10	25
0501 167 007	7703077117		BLACK COVER PLUG	MEGANE II, SCENIC, LAGUNA III	11	50
0501 167 008	7703081054		COVER PLUG FOR COARSE THREAD PP BLACK	CLIO 1, LAGUNA, LOGAN, R19, R25, R5, SAFRANE, SUPERCINQUE, TWINGO, R21, EXPRESS, MASTER, TRAFIC	12	50
0501 167 008	7703081227		COVER PLUG FOR COARSE THREAD PP BLACK	CLIO 1, LAGUNA, LOGAN, R19, R25, R5, SAFRANE, SUPERCINQUE, TWINGO, R21, EXPRESS, MASTER, TRAFIC	12	50
0501 167 009	7703046049		SILVER SHEET-METAL NUT	R-9/11, R-19, R-21, R-25, CLIO, SUPER-5, EXPRESS, LAGUNA, TWINGO, MASTER, TRAFFIC	16	100
0501 167 010	7703079822		DOUBLE ROD RETAINER, DIA. 4.6 - 5.0 MM + 4.6 - 5.0 MM	-	17	50
0501 167 011	7703044037		CAGE NUT M6 SPECIAL SILVER	CLIO, SCENIC, LAGUNA, KANGOO	19	25
0501 167 012	7703044087		CHAMPION CAGE NUT M6 SPECIAL PLASTIC/GALV.	R-9/11, R-19, R-21, SUPER-5, EXPRESS, CLIO, LAGUNA, SAFRANE, ESPACE, TWINGO, MASTER, TRAFIC	20	25
0501 167 013	7703081160		EXPANDING NUT PA66 - GF30 LIGHT GREEN	TWINGO, LAGUNA III	28	100
0501 167 014	7703081184		EXPANDING NUT PA 66 NATURAL	KANGOO II, MEGANE, SCENIC, TWINGO II	29	50
0501 167 016	7703081190		BLACK GROMMET	CLIO, ESPACE, LAGUNA, MASTER, MEGANE, SAFRANE, TRAFIC, TWINGO	33	100
0501 167 017	7703081151		BLACK GROMMET	CLIO, EXPRESS, LAGUNA, MASTER, MEGANE, SAFRANE, SUPER-5, TRAFIC, TWINGO	34	25
0501 167 018	7700836190		BLACK GROMMET	MEGANE, SCENIC	35	100
0501 167 019	7703077250		INTERIOR LINING CLIP POM COLORLESS	CLIO I, TWINGO, R19, MEGANE, R21, SAFRANE, KANGOO, MASTER, TRAFIC	37	100
0501 167 020	8200702219		INTERIOR LINING CLIP POM COLORLESS/ GREEN	LAGUNA II, SCENIC RX4, MEGANE CC, MODUS	38	25
0501 167 020	7701049008		INTERIOR LINING CLIP POM COLORLESS/ GREEN	LAGUNA II, SCENIC RX4, MEGANE CC, MODUS	38	25
0501 167 021	7703077368		INTERIOR LINING CLIP POM COLORLESS/ YELLOW	LAGUNA AB 2002	39	25
0501 167 022	7703077430		INTERIOR LINING CLIP POM COLORLESS/ GRAY	KANGOO, MEGANE, SCENIC	40	25
0501 167 023	7703077434		TWO-PIECE INTERIOR LINING CLIP POM BLACK	CLIO, KANGOO, TRAFIC II	41	100
0501 167 024	7703077322		INTERIOR LINING CLIP POM BLACK	-	45	50
0501 167 025	7703077362		COLORLESS TRIM CLIP	CLIO I PH 2, HAYON LAGUNA NEVADA I	47	25
0501 167 026	7703077448		COLORLESS TRIM CLIP	KANGOO, PHASE 2	48	50
0501 167 028	7703072360		BLACK RECURSION RIVET WITH SLOT	CLIO II, ESPACE IV, LAGUNA II, VEL SATIS, CLIO 3+4, KANGOO II, LAGUNA 3, MEGANE II, SCENIC II	53	25

Index sorted by Art. No.						
Art. No.	Orig. No.	Eurocode	Designation	Car type	Fig.	P. Qty.
0501 167 029	7803072272	7231LSCHFD	BLACK PLASTIC CLIP + ALU. PIN	R19, CLIO, MEGANE, SCENIC	58	100
0501 167 030	7703077256		SPECIAL PLUG COLORLESS	R19, CLIO, LAGUNA I, SAFRANE	60	100
0501 167 031	8200110307		COVER PLUG PA 66 GRAY	-	13	50
0501 167 033			WHITE TRIM CLIP	-	49	100
0501 167 058	7703072144		PLASTIC SPLIT RIVET PE 502 BLACK 4.8 - 5 MM*	ESPACE, EXPRESS, FUEGO, MASTER, R18, R20, R4, R5, SUPERCINQUE, TRAFIC, R9, R11	23	50
0501 167 059	7703081086		EXPANDING NUT PA 6 COLORLESS	CLIO 1, ESPACE, EXPRESS, FUEGO, MASTER, R11, R12, R18, R19, R21, R25, R9, SAFRANE, TRAFIC, TWINGO	30	25
0501 167 060	7703077428		WINDOW CLIP POM COLORLESS	-	59	10
0501 367 001	7700838570	7246ASCV	SPACER PP BLACK	CLIO II, CLIO III, KANGOO, LAGUNA II, MEGANE 1+2, SCENIC II	57	25
0501 367 002	7700351266	7247ASCV	BLACK SPACER	MASTER	54	25
0501 367 003	7700827632	7237ASCHBR	RIGHT-HAND SPACER BLACK	LAGUNA I	55	25
0501 367 004	7700827631	7237ASCHBL	LEFT-HAND SPACER BLACK	LAGUNA I	56	25

Index sorted by Orig. No.						
Orig. No.	Art. No.	Eurocode	Designation	Car type	Fig.	P. Qty.
	0500 523 14		PLASTIC SPLIT RIVET PA12 BLACK	-	21	50
5000355136	0500 132 300		FIR-TREE CLIP PE BLACK	-	1	50
7700351266	0501 367 002	7247ASCV	BLACK SPACER	MASTER	54	25
7700827631	0501 367 004	7237ASCHBL	LEFT-HAND SPACER BLACK	LAGUNA I	56	25
7700827632	0501 367 003	7237ASCHBR	RIGHT-HAND SPACER BLACK	LAGUNA I	55	25
7700836190	0501 167 018		BLACK GROMMET	MEGANE, SCENIC	35	100
7700838570	0501 367 001	7246ASCV	SPACER PP BLACK	CLIO II, CLIO III, KANGOO, LAGUNA II, MEGANE 1+2, SCENIC II	57	25
7701049270	0501 121 134	6545ASCTB 6539ASCHB	COLORLESS INTERIOR LINING CLIP	TWINGO II	44	25
7703044037	0501 167 011		CAGE NUT M6 SPECIAL SILVER	CLIO, SCENIC, LAGUNA, KANGOO	19	25
7703044087	0501 167 012		CHAMPION CAGE NUT M6 SPECIAL PLASTIC/GALV.	R-9/11, R-19, R-21, SUPER-5, EXPRESS, CLIO, LAGUNA, SAFRANE, ESPACE, TWINGO, MASTER, TRAFIC	20	25
7703046034	0500 533 12		SHEET-METAL NUT M 6 MET. CORR. PROT. 2.2 SI GLIDE ADDIT.	R-9/11, CLIO, SUPER-5, EXPRESS, LAGUNA, SAFRANE, ESPACE, MASTER, TRAFIC	15	100
7703046049	0501 167 009		SILVER SHEET-METAL NUT	R-9/11, R-19, R-21, R-25, CLIO, SUPER-5, EXPRESS, LAGUNA, TWINGO, MASTER, TRAFFIC	16	100
7703046115	0500 113 62		SHEET-METAL NUT ST 4.2 MM GALV. CLR. PASSIV.	-	14	100
7703072144	0501 167 058		PLASTIC SPLIT RIVET PE 502 BLACK 4.8 - 5 MM*	ESPACE, EXPRESS, FUEGO, MASTER, R18, R20, R4, R5, SUPERCINQUE, TRAFIC, R9, R11	23	50
7703072172	0500 127 10		PLASTIC SPLIT RIVET PA6 BK	TWINGO II	22	50
7703072173	0500 124 28		PLASTIC SPLIT RIVET PA 122 BLACK *	-	24	50
7703072224	0501 121 118	6539ASSH	BLACK PLASTIC SPLIT RIVET POM 902 BLACK 4.0 - 4.2 MM	-	26	100
7703072236	0501 121 140		THREADED BLIND RIVET POM BLACK	R19, R21, SUPER-5, EXPRESS, KANGOO, LAGUNA	51	100
7703072261	0501 121 141		THREADED BLIND RIVET WITH TORX DIA. 5.8 - 10.0 MM POM/PA 6 BLACK	-	52	25
7703072360	0501 167 028		BLACK RECURSION RIVET WITH SLOT	CLIO II, ESPACE IV, LAGUNA II, VEL SATIS, CLIO 3+4, KANGOO II, LAGUNA 3, MEGANE II, SCENIC II	53	25
7703072502	0501 101 628		PLASTIC SPLIT RIVET PA 12 BLACK*	-	25	25
7703077066	0500 682 9		FIR-TREE CLIP PA 66 BLACK	FUEGO, R18, R25, R5	4	50
7703077068	0500 680 3		COVER PLUG RENAULT/CITROËN POM BLACK	R-9, R-11, R-19, R-21, R-25, SUPER-5, EXPRESS, CLIO, MEGANE, TWINGO, LAGUNA, SAFRANE, ESPACE	5	50
7703077078	0501 121 122		PLASTIC RIVET WITHOUT PIN	R4, R5, SUPERCINQUE	27	100
7703077096	0500 680 7		COVER PLUG RENAULT GRAY	-	3	25
7703077111	0500 680 8		INTERIOR LINING CLIP FOR RENAULT/CITROËN	R11, R18, R5, R9, TRAFIC, SUPER-5, EXPRESS, MASTER	36	25

Index sorted by Orig. No.						
Orig. No.	Art. No.	Eurocode	Designation	Car type	Fig.	P. Qty.
7703077117	0501 167 007		BLACK COVER PLUG	MEGANE II, SCENIC, LAGUNA III	11	50
7703077135	0501 167 001		FIR-TREE CLIP DIA. 6.4 - 6.7 MM PE LD BLACK	-	2	100
7703077153	0501 167 006		BLACK COVER PLUG	CLIO	10	25
7703077225	0501 167 005		BLACK COVER PLUG	R-19, R-25, CLIO, SUPER-5, EXPRESS, KANGOO, MEGANE, TWINGO, LAGUNA, SAFRANE, MASTER, TRAFIC	9	50
7703077250	0501 167 019		INTERIOR LINING CLIP POM COLORLESS	CLIO I, TWINGO, R19, MEGANE, R21, SAFRANE, KANGOO, MASTER, TRAFIC	37	100
7703077256	0501 167 030		SPECIAL PLUG COLORLESS	R19, CLIO, LAGUNA I, SAFRANE	60	100
7703077322	0501 167 024		INTERIOR LINING CLIP POM BLACK	-	45	50
7703077362	0501 167 025		COLORLESS TRIM CLIP	CLIO I PH 2, HAYON LAGUNA NEVADA I	47	25
7703077368	0501 167 021		INTERIOR LINING CLIP POM COLORLESS/ YELLOW	LAGUNA AB 2002	39	25
7703077428	0501 167 060		WINDOW CLIP POM COLORLESS	-	59	10
7703077430	0501 167 022		INTERIOR LINING CLIP POM COLORLESS/ GRAY	KANGOO, MEGANE, SCENIC	40	25
7703077434	0501 167 023		TWO-PIECE INTERIOR LINING CLIP POM BLACK	CLIO, KANGOO, TRAFIC II	41	100
7703077435	0501 167 002		BLACK FIR-TREE CLIP	CLIO 1+2, ESPACE, KANGOO, LAGUNA 1+2, LOGAN, MASTER, MEGANE 1+2, MODUS, SCENIC 1+2, TRAFIC 2, TWINGO	6	25
7703077444	0501 167 003		BLACK COVER PLUG	CLIO II, KANGOO, LAGUNA	7	50
7703077448	0501 167 026		COLORLESS TRIM CLIP	KANGOO, PHASE 2	48	50
7703077453	0501 167 004		BLACK COVER PLUG	LAGUNA II, MASTER, VEL Satis	8	100
7703077469	0501 121 132		INTERIOR LINING CLIP POM COLORLESS	MEGANE II, CLIO II, CLIO III	43	25
7703079070	0500 531 64		PLASTIC CABLE CLAMP 9.5 MM PA 6 GRAY	UNIVERSAL	18	25
7703079822	0501 167 010		DOUBLE ROD RETAINER, DIA. 4.6 - 5.0 MM + 4.6 - 5.0 MM	-	17	50
7703081019	0501 121 125		COLORLESS EXPANDING NUT	R9, R11, CLIO, SUPER-5, EXPRESS, MEGANE, LAGUNA, SAFRANE, TWINGO, ESPACE, MASTER	32	100
7703081054	0501 167 008		COVER PLUG FOR COARSE THREAD PP BLACK	CLIO 1, LAGUNA, LOGAN, R19, R25, R5, SAFRANE, SUPERCINQUE, TWINGO, R21, EXPRESS, MASTER, TRAFIC	12	50
7703081227	0501 167 008		COVER PLUG FOR COARSE THREAD PP BLACK	CLIO 1, LAGUNA, LOGAN, R19, R25, R5, SAFRANE, SUPERCINQUE, TWINGO, R21, EXPRESS, MASTER, TRAFIC	12	50
7703081086	0501 167 059		EXPANDING NUT PA 6 COLORLESS	CLIO 1, ESPACE, EXPRESS, FUEGO, MASTER, R11, R12, R18, R19, R21, R25, R9, SAFRANE, TRAFIC, TWINGO	30	25

Index sorted by Orig. No.						
Orig. No.	Art. No.	Eurocode	Designation	Car type	Fig.	P. Qty.
7703081151	0501 167 017		BLACK GROMMET	CLIO, EXPRESS, LAGUNA, MASTER, MEGANE, SAFRANE, SUPER-5, TRAFIC, TWINGO	34	25
7703081160	0501 167 013		EXPANDING NUT PA66 - GF30 LIGHT GREEN	TWINGO, LAGUNA III	28	100
7703081176	0501 121 124		BLACK EXPANDING NUT	MEGANE, KANGOO, ESPACE, MASTER	31	50
7703081184	0501 167 014		EXPANDING NUT PA 66 NATURAL	KANGOO II, MEGANE, SCENIC, TWINGO II	29	50
7703081190	0501 167 016		BLACK GROMMET	CLIO, ESPACE, LAGUNA, MASTER, MEGANE, SAFRANE, TRAFIC, TWINGO	33	100
7803072272	0501 167 029	7231LSCHFD	BLACK PLASTIC CLIP + ALU. PIN	R19, CLIO, MEGANE, SCENIC	58	100
8200030701	0362 212 15		WHEEL BOLT GALV. CLR. M12X1.5X23 19 MM *	-	50	50
8200110307	0501 167 031		COVER PLUG PA 66 GRAY	-	13	50
8200702219	0501 167 020		INTERIOR LINING CLIP POM COLORLESS/ GREEN	LAGUNA II, SCENIC RX4, MEGANE CC, MODUS	38	25
7701049008	0501 167 020		INTERIOR LINING CLIP POM COLORLESS/ GREEN	LAGUNA II, SCENIC RX4, MEGANE CC, MODUS	38	25



Art. No. 0501 134 001
 Orig. No.: 91017AA010
 Fig. No.: 1



Art. No. 0501 134 002
 Orig. No.: 91017FA080
 Fig. No.: 2



Art. No. 0501 134 003
 Orig. No.: 91059FC090
 Fig. No.: 3

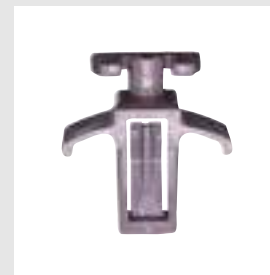

Art. No. 0501 134 007
 Orig. No.: 91059FC041
 Fig. No.: 4

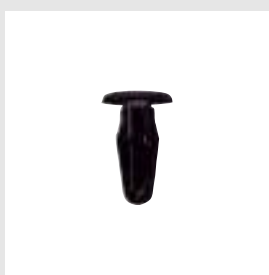

Art. No. 0501 134 004
 Orig. No.: 90331GA090
 Fig. No.: 5



Art. No. 0501 134 009
 Orig. No.: 909130051
 Fig. No.: 6



Art. No. 0501 134 008
 Orig. No.: 91017FA010
 Fig. No.: 7



Art. No. 0501 132 005
 Orig. No.: 57728AC090
 Fig. No.: 8



Art. No. 0501 134 006
 Orig. No.: 909140007
 Fig. No.: 9

Index sorted by Art. No.						
Art. No.	Orig. No.	Eurocode	Designation	Car type	Fig.	P. Qty.
0501 132 005	57728AC090		BLACK PLASTIC SPLIT RIVET*	-	8	25
0501 134 001	91017AA010		BLACK TRIM GRID CLIP*	-	1	100
0501 134 002	91017FA080		BLACK TRIM GRID CLIP*	-	2	100
0501 134 003	91059FC090		BLACK TRIM GRID CLIP *	-	3	100
0501 134 004	90331GA090		BLACK PLASTIC RIVET *	-	5	25
0501 134 006	909140007		BLACK RECURSION RIVET*	-	9	25
0501 134 007	91059FC041		GREY TRIM GRID CLIP*	-	4	50
0501 134 008	91017FA010		BLACK WINDOW CLIP *	IMPREZA 93 - 98, FORRESTER	7	25
0501 134 009	909130051		SCRIVET PBT + POM BLACK WITH PH DRIVE *	-	6	25

Index sorted by Orig. No.						
Orig. No.	Art. No.	Eurocode	Designation	Car type	Fig.	P. Qty.
57728AC090	0501 132 005		BLACK PLASTIC SPLIT RIVET *	-	8	25
90331GA090	0501 134 004		BLACK PLASTIC RIVET *	-	5	25
909130051	0501 134 009		SCRIVET PBT + POM BLACK WITH PH DRIVE *	-	6	25
909140007	0501 134 006		BLACK RECURSION RIVET*	-	9	25
91017AA010	0501 134 001		BLACK TRIM GRID CLIP*	-	1	100
91017FA010	0501 134 008		BLACK WINDOW CLIP *	IMPREZA 93 - 98, FORRESTER	7	25
91017FA080	0501 134 002		BLACK TRIM GRID CLIP*	-	2	100
91059FC041	0501 134 007		GREY TRIM GRID CLIP*	-	4	50
91059FC090	0501 134 003		BLACK TRIM GRID CLIP *	-	3	100

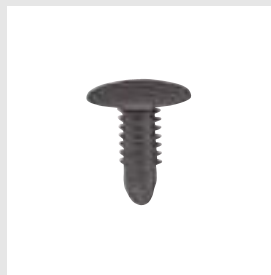

Art. No. 0501 136 007
 Orig. No.: 0940905309T01
 Fig. No.: 1

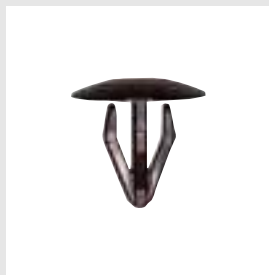

Art. No. 0500 777 8
 Orig. No.: 09409M10302
 Fig. No.: 2



Art. No. 0501 136 010
 Orig. No.: 094098322000
 Fig. No.: 3



Art. No. 0500 777 3
 Orig. No.: 09409073055PK
 Fig. No.: 4



Art. No. 0501 129 003
 Orig. No.: 0940907332000
 Fig. No.: 5



Art. No. 0501 136 004
 Orig. No.: 0940908327000
 Fig. No.: 6



Art. No. 0501 136 006
 Orig. No.: 09409073255PK
 Fig. No.: 7



Art. No. 0501 136 002
 Orig. No.: 0940907308T01
 Fig. No.: 8



Art. No. 0501 136 003
 Orig. No.: 09409073085EE
 Fig. No.: 9



Art. No. 0501 136 001
 Orig. No.: 09409073085PK
 Fig. No.: 10

Index sorted by Art. No.						
Art. No.	Orig. No.	Eurocode	Designation	Car type	Fig.	P. Qty.
0500 777 3	09409073055PK		BLACK THREADED BLIND RIVET TOYOTA *	UNIVERSAL	4	25
0500 777 8	09409M10302		BLACK PLASTIC RIVET TOYOTA *	-	2	25
0501 129 003	0940907332000		RECURSION RIVET POM BLACK *	JIMNY, SWIFT	5	25
0501 136 001	09409073085PK		RECURSION RIVET POM BLACK *	UNIVERSAL	10	25
0501 136 002	0940907308T01		GREY RECURSION RIVET*	-	8	100
0501 136 003	09409073085EE		GRAY RECURSION RIVET*	-	9	25
0501 136 004	0940908327000		BLACK RECURSION RIVET*	-	6	25
0501 136 006	09409073255PK		BLACK RECURSION RIVET*	JIMMY	7	25
0501 136 007	0940905309T01		GREY FIR-TREE CLIP*	-	1	100
0501 136 010	094098322000		INTERIOR LINING CLIP PA COLORLESS *	JIMNY, VITARA, GRAN VITARA, SWIFT	3	10

Index sorted by Orig. No.						
Orig. No.	Art. No.	Eurocode	Designation	Car type	Fig.	P. Qty.
0940905309T01	0501 136 007		GREY FIR-TREE CLIP*	-	1	100
09409073055PK	0500 777 3		BLACK THREADED BLIND RIVET TOYOTA*	UNIVERSAL	4	25
09409073085EE	0501 136 003		GRAY RECURSION RIVET*	-	9	25
09409073085PK	0501 136 001		RECURSION RIVET POM BLACK*	UNIVERSAL	10	25
0940907308T01	0501 136 002		GREY RECURSION RIVET*	-	8	100
09409073255PK	0501 136 006		BLACK RECURSION RIVET*	JIMMY	7	25
0940907332000	0501 129 003		RECURSION RIVET POM BLACK *	JIMNY, SWIFT	5	25
0940908327000	0501 136 004		BLACK RECURSION RIVET*	-	6	25
094098322000	0501 136 010		INTERIOR LINING CLIP PA COLORLESS *	JIMNY, VITARA, GRAN VITARA, SWIFT	3	10
09409M10302	0500 777 8		BLACK PLASTIC RIVET TOYOTA*	-	2	25



Art. No. 0501 130 041
 Orig. No.: 9046709050
 Fig. No.: 1



Art. No. 0501 130 042
 Orig. No.: 904670900801
 Fig. No.: 2



Art. No. 0500 779 3
 Orig. No.: 5387914010
 Fig. No.: 3

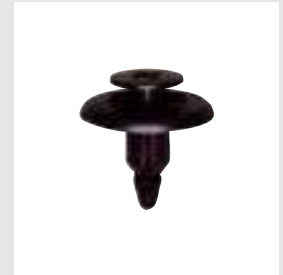

Art. No. 0501 130 025
 Orig. No.: 9046706150C0
 Fig. No.: 4



Art. No. 0500 772 9
 Orig. No.: 904670906901
 Fig. No.: 5



Art. No. 0501 130 001
 Orig. No.: 9046708030
 Fig. No.: 6

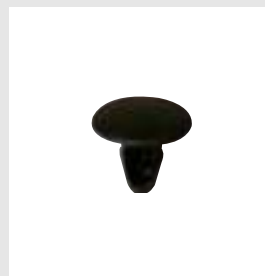

Art. No. 0500 771 6
 Orig. No.: 904670616101
 Fig. No.: 7

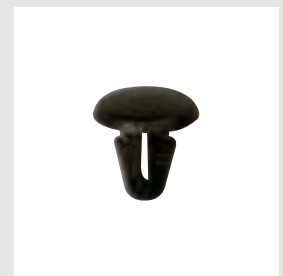

Art. No. 0500 772 8
 Orig. No.: 9046709064
 Fig. No.: 8



Art. No. 0500 773 4
 Orig. No.: 9046709084
 Fig. No.: 9



Art. No. 0500 774 0
 Orig. No.: 9046709004
 904670900401
 Fig. No.: 10

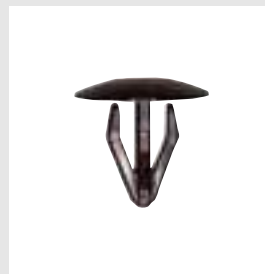

Art. No. 0500 777 8
 Orig. No.: 9046710015
 Fig. No.: 11

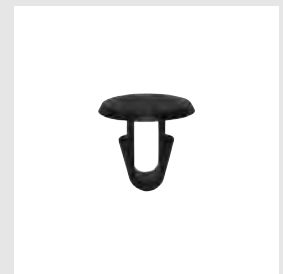

Art. No. 0501 130 002
 Orig. No.: 9046708011
 Fig. No.: 12

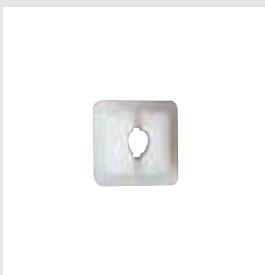

Art. No. 0500 771 1
 Orig. No.: 9018905013
 Fig. No.: 13



Art. No. 0500 775 8
 Orig. No.: 9018906006
 Fig. No.: 14



Art. No. 0500 776 0
 Orig. No.: 9018906018
 Fig. No.: 15



Art. No. 0500 774 7
 Orig. No.: 9018906013
 Fig. No.: 16



Art. No. 0500 788 026
 Orig. No.: 9018906001
 Fig. No.: 17

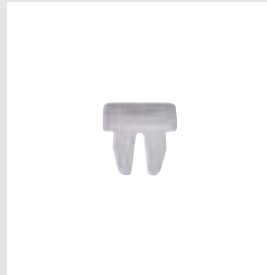

Art. No. 0500 771 0
 Orig. No.: 9018904014
 Fig. No.: 18



Art. No. 0500 770 9
 Orig. No.: 9018904011
 Fig. No.: 19



Art. No. 0500 771 4
 Orig. No.: 9018906010
 Fig. No.: 20

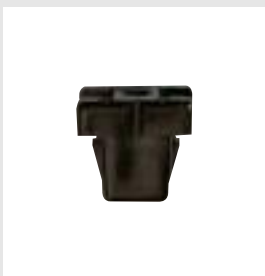

Art. No. 0500 773 7
 Orig. No.: 9018904008
 Fig. No.: 21



Art. No. 0500 775 7
 Orig. No.: 9018906005
 Fig. No.: 22



Art. No. 0500 778 5
 Orig. No.: 9018906049
 Fig. No.: 23



Art. No. 0501 130 003
 Orig. No.: 9018906211
 Fig. No.: 24



Art. No. 0501 130 026
 Orig. No.: 9046711117
 Fig. No.: 25



Art. No. 0501 130 043
 Orig. No.: 9018906224
 Fig. No.: 26



Art. No. 0362 112 15
 Orig. No.: 909420100783
 DENG90942098
 Fig. No.: 27

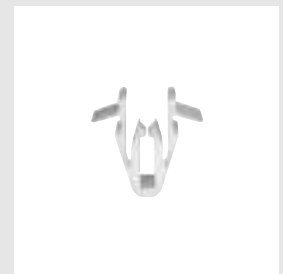

Art. No. 0501 130 044
 Orig. No.: 9046709204
 Fig. No.: 28



Art. No. 0500 770 6
 Orig. No.: 6777112010
 Fig. No.: 29



Art. No. 0501 130 004
 Orig. No.: 9046710161
 Fig. No.: 30



Art. No. 0501 130 027
 Orig. No.: 9046711106
 Fig. No.: 31



Art. No. 0501 130 028
 Orig. No.: 7539748020
 Fig. No.: 32



Art. No. 0501 130 029
 Orig. No.: 6295512010
 Fig. No.: 33



Art. No. 0501 130 030
 Orig. No.: 7539748030
 Fig. No.: 34

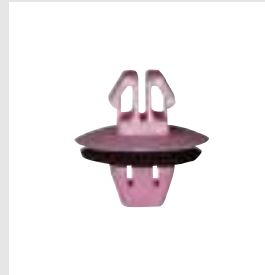

Art. No. 0501 130 031
 Orig. No.: 7539533030
 Fig. No.: 35

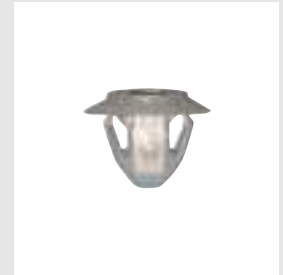

Art. No. 0501 130 032
 Orig. No.: 7539630260
 Fig. No.: 36



Art. No. 0501 130 045
 Orig. No.: 7539260031
 Fig. No.: 37



Art. No. 0501 130 046
 Orig. No.: 9046710162
 Fig. No.: 38

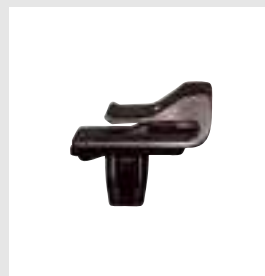

Art. No. 0501 130 033
 Orig. No.: 7539648020
 Fig. No.: 39



Art. No. 0501 130 034
 Orig. No.: 9046712074
 Fig. No.: 40



Art. No. 0501 130 048
 Orig. No.: 7539860021
 7539860020
 Fig. No.: 41



Art. No. 0501 130 049
 Orig. No.: 7588260010
 Fig. No.: 42



Art. No. 0501 130 050
 Orig. No.: 7549260020
 Fig. No.: 43



Art. No. 0501 130 006
 Orig. No.: 9046706017
 Fig. No.: 44



Art. No. 0500 777 3
 Orig. No.: 9046706017
 Fig. No.: 45

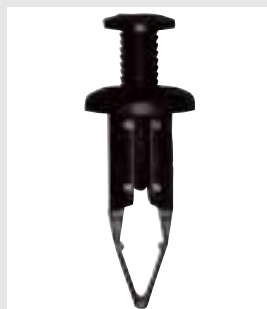

Art. No. 0501 130 052
 Orig. No.: 9046709093
 Fig. No.: 46

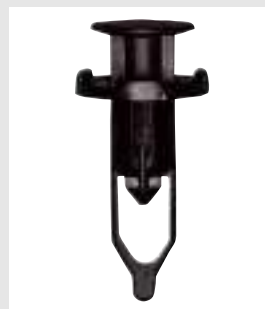

Art. No. 0501 130 024
 Orig. No.: 5216116010
 Fig. No.: 47



Art. No. 0501 130 053
 Orig. No.: 9046706198
 Fig. No.: 48



Art. No. 0501 129 003
 Orig. No.: 9046707164
 Fig. No.: 49



Art. No. 0501 130 008
 Orig. No.: 9046710183
 9046707183
 Fig. No.: 50



Art. No. 0501 130 009
 Orig. No.: 9046707066
 Fig. No.: 51

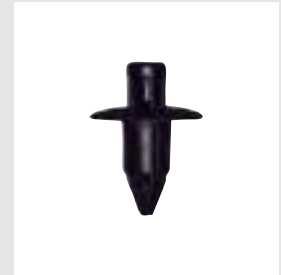

Art. No. 0501 130 010
 Orig. No.: 9046707041
 Fig. No.: 52



Art. No. 0501 130 054
 Orig. No.: 9046708143
 Fig. No.: 53



Art. No. 0501 130 055
 Orig. No.: 9046707166
 Fig. No.: 54



Art. No. 0501 130 056
 Orig. No.: 9046707146
 Fig. No.: 55



Art. No. 0501 130 021
 Orig. No.: 5215521020
 Fig. No.: 56



Art. No. 0501 130 022
 Orig. No.: 5215521010
 Fig. No.: 57



Art. No. 0501 130 023

Orig. No.: 5215544010

Fig. No.: 58

Index sorted by Art. No.						
Art. No.	Orig. No.	Eurocode	Designation	Car type	Fig.	P. Qty.
0362 112 15	909420100783		WHEEL NUT M12x1.5 21 MM GALV. 3 *	-	27	100
0362 112 15	DENG90942098		WHEEL NUT M12x1.5 21 MM GALV. 3 *	-	27	100
0500 770 6	6777112010		INTERIOR LINING CLIP TOYOTA*	-	29	25
0500 770 9	9018904011		NATURAL EXPANDING NUT TOYOTA*	-	19	25
0500 771 0	9018904014		NATURAL EXPANDING NUT TOYOTA*	-	18	25
0500 771 1	9018905013		EXPANDING NUT*	-	13	25
0500 771 4	9018906010		NATURAL EXPANDING NUT TOYOTA*	CARINA	20	25
0500 771 6	904670616101		BLACK PLASTIC RIVET TOYOTA*	VARIOUS MODELS	7	25
0500 772 8	9046709064		BLACK PLASTIC RIVET TOYOTA*	-	8	25
0500 772 9	904670906901		BLACK PLASTIC RIVET*	VARIOUS MODELS	5	25
0500 773 4	9046709084		BLACK PLASTIC RIVET TOYOTA*	-	9	25
0500 773 7	9018904008		BLACK EXPANDING NUT TOYOTA*	-	21	25
0500 774 0	9046709004		BLACK PLASTIC RIVET WITHOUT PIN TOYOTA*	-	10	25
0500 774 0	904670900401		BLACK PLASTIC RIVET WITHOUT PIN TOYOTA*	-	10	25
0500 774 7	9018906013		EXPANDING NUT PA 6 BLACK*	VARIOUS MODELS	16	25
0500 775 7	9018906005		COLORLESS EXPANDING NUT TOYOTA*	VARIOUS MODELS	22	25
0500 775 8	9018906006		COLORLESS EXPANDING NUT*	VARIOUS MODELS	14	25
0500 776 0	9018906018		YELLOW EXPANDING NUT*	VARIOUS MODELS	15	25
0500 777 3	9046706017		BLACK THREADED BLIND RIVET TOYOTA*	-	45	25
0500 777 8	9046710015		BLACK PLASTIC RIVET TOYOTA*	-	11	25
0500 778 5	9018906049		YELLOW EXPANDING NUT TOYOTA*	-	23	25
0500 779 3	5387914010		SHEET-METAL NUT PLASTIC BLACK*	RX300, CAMRY, CARINA, CELICA, COROLLA, MR2, PREVIA, TERCEL	3	25
0500 788 026	9018906001		EXPANDING NUT DATSUN/TOYOTA/MITSUB*	-	17	25
0501 129 003	9046707164		RECURSION RIVET POM BLACK *	VARIOUS MODELS	49	25
0501 130 001	9046708030		BLACK PLASTIC RIVET*	CAMRY, CELICA, COROLLA, LAND CRUISER, STARLET	6	25
0501 130 002	9046708011		PLASTIC RIVET PA 6 BLACK*	CAMRY, CARINA 2, CELICA, COROLLA, HILUX, LAND CRUISER, LEXUS LS400, LEXUS RX300, MR2, PIC-NIC, PREVIA, PRIUS, RUNNER 4, STARLET, SUPRA, YARIS	12	25
0501 130 003	9018906211		BLACK EXPANDING NUT *	-	24	100
0501 130 004	9046710161		COLORLESS INTERIOR LINING CLIP*	AVENSIS, AYGO, CAMRY, CELICA, COROLLA, HILUX, LAND CRUISER, LEXUS LS430, LEXUS RX300, MR2, PREVIA, RAV 4, VERSO, YARIS	30	25
0501 130 006	9046706017		BLACK THREADED BLIND RIVET *	-	44	25
0501 130 008	9046710183		BLACK RECURSION RIVET*	COROLLA, YARIS	50	25
0501 130 008	9046707183		BLACK RECURSION RIVET*	COROLLA, YARIS	50	25
0501 130 009	9046707066		BLACK RECURSION RIVET *	-	51	25
0501 130 010	9046707041		RECURSION RIVET POM BLACK *	-	52	25
0501 130 021	5215521020		BLUE BUMPER FASTENING CLIP *	CARINA	56	10
0501 130 022	5215521010		BLACK BUMPER FASTENING CLIP *	CARINA	57	10
0501 130 023	5215544010		WHITE BUMPER FASTENING CLIP *	-	58	10
0501 130 024	5216116010		BLACK RECURSION RIVET *	COROLLA, CELICA	47	50
0501 130 025	9046706150CO		PLASTIC SPLIT RIVET WITH PH DRIVE BLACK *	-	4	50
0501 130 026	9046711117		COLORLESS EXPANDING NUT *	-	25	50

Index sorted by Art. No.						
Art. No.	Orig. No.	Eurocode	Designation	Car type	Fig.	P. Qty.
0501 130 027	9046711106		YELLOW INTERIOR LINING CLIP *	-	31	50
0501 130 028	7539748020		YELLOW INTERIOR LINING CLIP + SEAL *	-	32	50
0501 130 029	6295512010		COLORLESS/WHITE INTERIOR LINING CLIP *	UNIVERSAL	33	50
0501 130 030	7539748030		ORANGE INTERIOR LINING CLIP *	-	34	50
0501 130 031	7539533030		PINK INTERIOR LINING CLIP *	UNIVERSAL	35	10
0501 130 032	7539630260		COLORLESS INTERIOR LINING CLIP *	-	36	50
0501 130 033	7539648020		BLACK TRIM CLIP *	-	39	50
0501 130 034	9046712074		WHITE TRIM CLIP *	-	40	50
0501 130 041	9046709050		COVER PLUG PA BLACK*	COROLLA, VERSO, YARIS	1	25
0501 130 042	904670900801		COVER PLUG PA BLACK*	CARINA, CELICA, CRESSIDA, LAND CRUISER, MR2	2	25
0501 130 043	9018906224		EXPANDING NUT PA GRAY *	COROLLA	26	25
0501 130 044	9046709204		PLASTIC PLUG-IN CLIP PA COLORLESS*	-	28	25
0501 130 045	7539260031		INTERIOR LINING CLIP POM GRAY*	-	37	25
0501 130 046	9046710162		INTERIOR LINING CLIP POM COLORLESS*	CELICA, LEXUS RX300, YARIS	38	25
0501 130 048	7539860021		TRIM CLIP POM YELLOW*	-	41	10
0501 130 048	7539860020		TRIM CLIP POM YELLOW*	-	41	10
0501 130 049	7588260010		TRIM CLIP POM YELLOW WITH FOAM SEAL BK*	-	42	10
0501 130 050	7549260020		TRIM CLIP POM BLUE WITH FOAM SEAL BK*	-	43	10
0501 130 052	9046709093		THREADED BLIND RIVET POM BLACK*	COROLLA, LS400	46	10
0501 130 053	9046706198		THREADED BLIND RIVET PA BLACK*	YARIS	48	10
0501 130 054	9046708143		RECURSION RIVET POM BLACK *	-	53	10
0501 130 055	9046707166		RECURSION RIVET PBT + POM BLACK *	PREVIA, YARIS	54	25
0501 130 056	9046707146		RECURSION RIVET PBT + POM BLACK *	VARIOUS MODELS	55	10

Index sorted by Orig. No.						
Orig. No.	Art. No.	Eurocode	Designation	Car type	Fig.	P. Qty.
5215521010	0501 130 022		BLACK BUMPER FASTENING CLIP *	CARINA	57	10
5215521020	0501 130 021		BLUE BUMPER FASTENING CLIP *	CARINA	56	10
5215544010	0501 130 023		WHITE BUMPER FASTENING CLIP *	-	58	10
5216116010	0501 130 024		BLACK RECURSION RIVET *	COROLLA, CELICA	47	50
5387914010	0500 779 3		SHEET-METAL NUT PLASTIC BLACK*	RX300, CAMRY, CARINA, CELICA, COROLLA, MR2, PREVIA, TERCEL	3	25
6295512010	0501 130 029		COLORLESS/WHITE INTERIOR LINING CLIP *	UNIVERSAL	33	50
6777112010	0500 770 6		INTERIOR LINING CLIP TOYOTA*	-	29	25
7539260031	0501 130 045		INTERIOR LINING CLIP POM GRAY*	-	37	25
7539533030	0501 130 031		PINK INTERIOR LINING CLIP *	UNIVERSAL	35	10
7539630260	0501 130 032		COLORLESS INTERIOR LINING CLIP *	-	36	50
7539648020	0501 130 033		BLACK TRIM CLIP *	-	39	50
7539748020	0501 130 028		YELLOW INTERIOR LINING CLIP + SEAL *	-	32	50
7539748030	0501 130 030		ORANGE INTERIOR LINING CLIP *	-	34	50
7539860021	0501 130 048		TRIM CLIP POM YELLOW*	-	41	10
7539860020	0501 130 048		TRIM CLIP POM YELLOW*	-	41	10
7549260020	0501 130 050		TRIM CLIP POM BLUE WITH FOAM SEAL BK*	-	43	10
7588260010	0501 130 049		TRIM CLIP POM YELLOW WITH FOAM SEAL BK*	-	42	10
9018904008	0500 773 7		BLACK EXPANDING NUT TOYOTA*	-	21	25
9018904011	0500 770 9		NATURAL EXPANDING NUT TOYOTA*	-	19	25
9018904014	0500 771 0		NATURAL EXPANDING NUT TOYOTA*	-	18	25
9018905013	0500 771 1		EXPANDING NUT*	-	13	25
9018906001	0500 788 026		EXPANDING NUT DATSUN/TOYOTA/MITSUB*	-	17	25
9018906005	0500 775 7		COLORLESS EXPANDING NUT TOYOTA*	VARIOUS MODELS	22	25
9018906006	0500 775 8		COLORLESS EXPANDING NUT*	VARIOUS MODELS	14	25
9018906010	0500 771 4		NATURAL EXPANDING NUT TOYOTA*	CARINA	20	25
9018906013	0500 774 7		EXPANDING NUT PA 6 BLACK*	VARIOUS MODELS	16	25
9018906018	0500 776 0		YELLOW EXPANDING NUT*	VARIOUS MODELS	15	25
9018906049	0500 778 5		YELLOW EXPANDING NUT TOYOTA*	-	23	25
9018906211	0501 130 003		BLACK EXPANDING NUT *	-	24	100
9018906224	0501 130 043		EXPANDING NUT PA GRAY *	COROLLA	26	25
9046706017	0501 130 006		BLACK THREADED BLIND RIVET *	-	44	25
9046706150CO	0501 130 025		PLASTIC SPLIT RIVET WITH PH DRIVE BLACK *	-	4	50
904670616101	0500 771 6		BLACK PLASTIC RIVET TOYOTA*	VARIOUS MODELS	7	25
9046706198	0501 130 053		THREADED BLIND RIVET PA BLACK*	YARIS	48	10
9046707041	0501 130 010		RECURSION RIVET POM BLACK *	-	52	25
9046707066	0501 130 009		BLACK RECURSION RIVET *	-	51	25
9046707146	0501 130 056		RECURSION RIVET PBT + POM BLACK *	VARIOUS MODELS	55	10
9046707164	0501 129 003		RECURSION RIVET POM BLACK *	VARIOUS MODELS	49	25
9046707166	0501 130 055		RECURSION RIVET PBT + POM BLACK *	PREVIA, YARIS	54	25
9046708011	0501 130 002		PLASTIC RIVET PA 6 BLACK*	CAMRY, CARINA 2, CELICA, COROLLA, HILUX, LAND CRUISER, LEXUS LS400, LEXUS RX300, MR2, PIC-NIC, PREVIA, PRIUS, RUNNER 4, STARLET, SUPRA, YARIS	12	25
9046708030	0501 130 001		BLACK PLASTIC RIVET*	CAMRY, CELICA, COROLLA, LAND CRUISER, STARLET	6	25

Index sorted by Orig. No.						
Orig. No.	Art. No.	Eurocode	Designation	Car type	Fig.	P. Qty.
9046708143	0501 130 054		RECURSION RIVET POM BLACK *	-	53	10
9046709004	0500 774 0		BLACK PLASTIC RIVET WITHOUT PIN TOYOTA*	-	10	25
904670900401	0500 774 0		BLACK PLASTIC RIVET WITHOUT PIN TOYOTA*	-	10	25
904670900801	0501 130 042		COVER PLUG PA BLACK*	CARINA, CELICA, CRESSIDA, LAND CRUISER, MR2	2	25
9046709050	0501 130 041		COVER PLUG PA BLACK*	COROLLA, VERSO, YARIS	1	25
9046709064	0500 772 8		BLACK PLASTIC RIVET TOYOTA*	-	8	25
904670906901	0500 772 9		BLACK PLASTIC RIVET*	VARIOUS MODELS	5	25
9046709084	0500 773 4		BLACK PLASTIC RIVET TOYOTA*	-	9	25
9046709093	0501 130 052		THREADED BLIND RIVET POM BLACK*	COROLLA, LS400	46	10
9046709204	0501 130 044		PLASTIC PLUG-IN CLIP PA COLORLESS*	-	28	25
9046710015	0500 777 8		BLACK PLASTIC RIVET TOYOTA*	-	11	25
9046710161	0501 130 004		COLORLESS INTERIOR LINING CLIP*	AVENSIS, AYGO, CAMRY, CELICA, COROLLA, HILUX, LAND CRUISER, LEXUS LS430, LEXUS RX300, MR2, PREVIA, RAV 4, VERSO, YARIS	30	25
9046710162	0501 130 046		INTERIOR LINING CLIP POM COLORLESS*	CELICA, LEXUS RX300, YARIS	38	25
9046710183	0501 130 008		BLACK RECURSION RIVET*	COROLLA, YARIS	50	25
9046707183	0501 130 008		BLACK RECURSION RIVET*	COROLLA, YARIS	50	25
9046711106	0501 130 027		YELLOW INTERIOR LINING CLIP *	-	31	50
9046711117	0501 130 026		COLORLESS EXPANDING NUT *	-	25	50
9046712074	0501 130 034		WHITE TRIM CLIP *	-	40	50
909420100783	0362 112 15		WHEEL NUT M12x1.5 21 MM GALV. 3 *	-	27	100
DENG90942098	0362 112 15		WHEEL NUT M12x1.5 21 MM GALV. 3 *	-	27	100

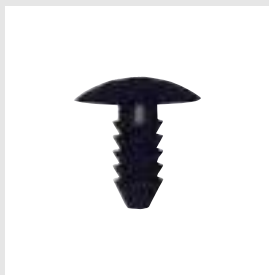

Art. No. 0500 132 170
Orig. No.: 1224786
Fig. No.: 1

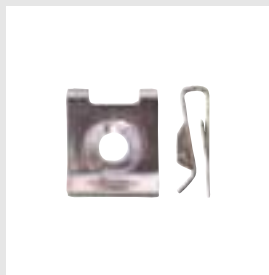

Art. No. 0500 116 67
Orig. No.: 948571
Fig. No.: 2



Art. No. 0500 114 27
Orig. No.: 946418
Fig. No.: 3



Art. No. 0501 101 646
Orig. No.: 949921
Fig. No.: 4

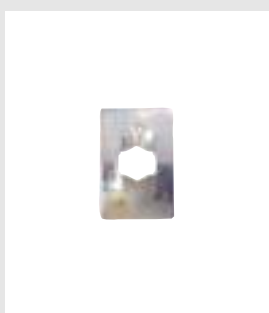

Art. No. 0500 111 82
Orig. No.: 82660
Fig. No.: 5

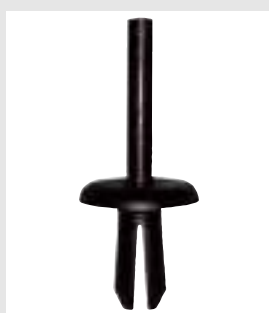

Art. No. 0500 141 42
Orig. No.: 1268176
Fig. No.: 6



Art. No. 0500 124 28
Orig. No.: 947098
Fig. No.: 7



Art. No. 0501 103 035
Orig. No.: 3923475
Fig. No.: 8



Art. No. 0500 201 404
Orig. No.: 30820141
Fig. No.: 9



Art. No. 0501 141 007
Orig. No.: 680097
Fig. No.: 10

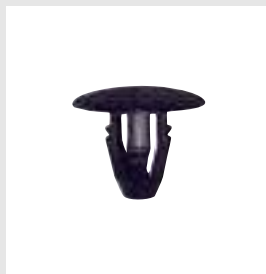

Art. No. 0501 167 024
Orig. No.: 3272075
3274628
Fig. No.: 11



Art. No. 0500 116 39
Orig. No.: 3104426
Fig. No.: 12

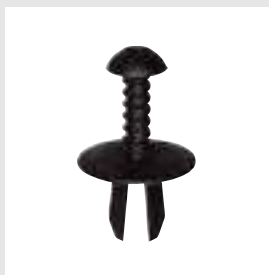

Art. No. 0501 104 039
Orig. No.: 3120254
Fig. No.: 13



Art. No. 0501 341 004
Orig. No.: 30800958
Eurocode: 8824ASCS6B
Fig. No.: 14

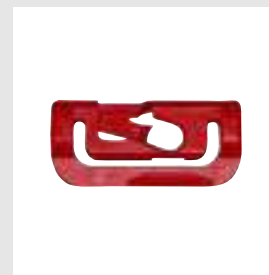

Art. No. 0501 341 001
Orig. No.: 30873201
Eurocode: 8824ASCS7B
Fig. No.: 15

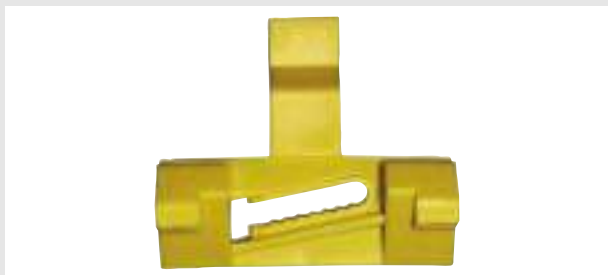

Art. No. 0501 341 002

Orig. No.: 30678009
Eurocode: 8829ASCSS
Fig. No.: 16



Art. No. 0501 341 003

Orig. No.: 9190981
Eurocode: 8829ASCES1B
Fig. No.: 17

Index sorted by Art. No.						
Art. No.	Orig. No.	Eurocode	Designation	Car type	Fig.	P. Qty.
0500 111 82	82660		SPRING NUT 4.0 MM GALV. CLR. PASSIV.	-	5	100
0500 114 27	946418		SHEET-METAL NUT ST 6.3 MM GALV.	-	3	100
0500 116 39	3104426		PAPERBOARD CLIP GALV. CLR.	-	12	25
0500 116 67	948571		SHEET-METAL NUT ST 4.2 MM GALV. CLR. PASSIV.	-	2	100
0500 124 28	947098		PLASTIC SPLIT RIVET PA 1 22 BLACK *	-	7	50
0500 132 170	1224786		FIR-TREE CLIP PE BLACK	-	1	50
0500 141 42	1268176		PLASTIC SPLIT RIVET POM 232 BLACK	740, 760	6	25
0500 201 404	30820141		PLASTIC SPLIT RIVET PA 6 BLACK	-	9	25
0501 101 646	949921		SHEET-METAL NUT M 6 MET. CORR. PROT. 2.2 SW GLIDE ADDIT.	-	4	100
0501 103 035	3923475		PLASTIC SPLIT RIVET PA 661 BLACK	-	8	25
0501 104 039	3120254		THREADED BLIND RIVET FOR WHEEL INSTAL. PARTI. WALL	-	13	50
0501 141 007	680097		INTERIOR LINING CLIP POM BLACK	UNIVERSAL	10	10
0501 167 024	3272075		INTERIOR LINING CLIP POM BLACK	-	11	50
0501 167 024	3274628		INTERIOR LINING CLIP POM BLACK	-	11	50
0501 341 001	30873201	8824ASCS7B	RED WINDOW CLIP	S40, V40	15	25
0501 341 002	30678009	8829ASCSS	YELLOW WINDOW CLIP	S60, V70, XC70	16	25
0501 341 003	9190981	8829ASCES1B	WINDOW CLIP POM WHITE	S60, V70, XC70, S80	17	25
0501 341 004	30800958	8824ASCS6B	NATURAL ROOF TRIM CLIP	S40, V40	14	25

Index sorted by Orig. No.						
Orig. No.	Art. No.	Eurocode	Designation	Car type	Fig.	P. Qty.
1224786	0500 132 170		FIR-TREE CLIP PE BLACK	-	1	50
1268176	0500 141 42		PLASTIC SPLIT RIVET POM 232 BLACK	740, 760	6	25
30678009	0501 341 002	8829ASCSS	YELLOW WINDOW CLIP	S60, V70, XC70	16	25
30800958	0501 341 004	8824ASCS6B	NATURAL ROOF TRIM CLIP	S40, V40	14	25
30820141	0500 201 404		PLASTIC SPLIT RIVET PA 6 BLACK	-	9	25
30873201	0501 341 001	8824ASCS7B	RED WINDOW CLIP	S40, V40	15	25
3104426	0500 116 39		PAPERBOARD CLIP GALV. CLR.	-	12	25
3120254	0501 104 039		THREADED BLIND RIVET FOR WHEEL INSTAL. PARTI. WALL	-	13	50
3272075	0501 167 024		INTERIOR LINING CLIP POM BLACK	-	11	50
3274628	0501 167 024		INTERIOR LINING CLIP POM BLACK	-	11	50
3923475	0501 103 035		PLASTIC SPLIT RIVET PA 661 BLACK	-	8	25
680097	0501 141 007		INTERIOR LINING CLIP POM BLACK	UNIVERSAL	10	10
82660	0500 111 82		SPRING NUT 4.0 MM GALV. CLR. PASSIV.	-	5	100
9190981	0501 341 003	8829ASCES1B	WINDOW CLIP POM WHITE	S60, V70, XC70, S80	17	25
946418	0500 114 27		SHEET-METAL NUT ST 6.3 MM GALV.	-	3	100
947098	0500 124 28		PLASTIC SPLIT RIVET PA 122 BLACK *	-	7	50
948571	0500 116 67		SHEET-METAL NUT ST 4.2 MM GALV. CLR. PASSIV.	-	2	100
949921	0501 101 646		SHEET-METAL NUT M 6 MET. CORR. PROT. 2.2 SW GLIDE ADDIT.	-	4	100

